

Cable Plug acc. to DIN EN 175301-803, Form C



- Installation width 16 mm
- Protection class IP 65
- Numerous variants
- Also available with moulded-on cable connection
- Contact form 8 mm

Plug for the connection of electrical components according to DIN EN 175301-803 Form C (previously DIN 43650).

Technical data	
Body material	Polyamide
Contact material	Brass, electro-silver-plated
Max. continuous temperature without cable with cable	+90 °C +80 °C
Cable diameter	5 - 6 mm
Cable outlet without cable with cable	Oriented 30° to the plug face Straight
Functional display	LED, colour yellow
Nominal voltage	0 to 250 V
Maximum current rating	With diode, 1 A Without circuitry, 3 A
Contact resistance	5 mΩ
Electrical connection	Terminal screws max. 0.75 mm ²
Protection class	IP 65
Number of terminals	2 pins + protective earth

Ordering chart

The delivery of a cable plug includes the flat seal and fixing screw

Voltage	Current rating	Item no. without cable	Item no. with 2 m cable
Without circuitry			
0 to 250 V/AC/DC	max. 3 A	008 353	423 862
With LED			
12 to 24 V/AC/DC	max. 3 A	008 402	423 863
100 to 120 V/AC/DC	max. 3 A	008 403	-
200 to 240 V/AC/DC	max. 3 A	008 404	-
With rectifier, varistor and LED			
12 to 24 V/AC/DC	max. 1 A	008 354	-
100 to 120 V/AC/DC	max. 1 A	008 355	-
200 to 240 V/AC/DC	max. 1 A	008 356	-
With LED and varistor			
12 to 24 V/AC/DC	max. 3 A	008 408	-
100 to 120 V/AC/DC	max. 3 A	008 409	-
200 to 240 V/AC/DC	max. 3 A	008 410	-
With pole protection, free-wheeling diode and LED			
12 to 24 V/DC	max. 1 A	008 411	-
With rectifier and varistor			
12 to 240 V/AC/DC	max. 1 A	008 412	-

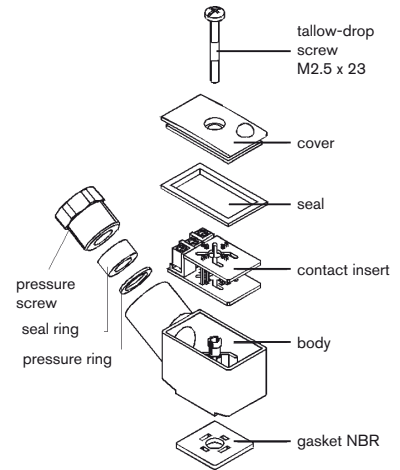

Circuit

Without circuitry

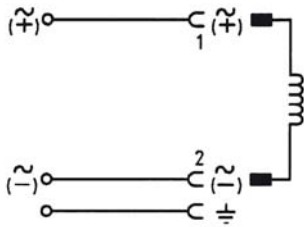

With LED

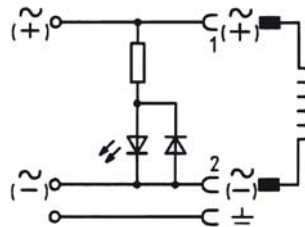

With rectifier, varistor and LED

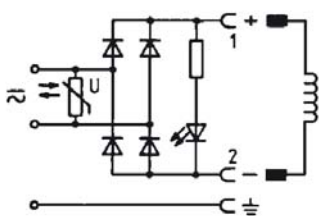

With LED and varistor

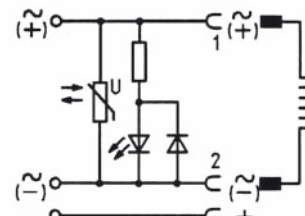

Circuit, continued

With pole protection, free wheeling diode and LED

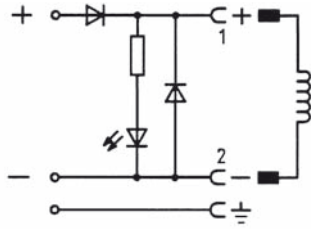

With rectifier and varistor

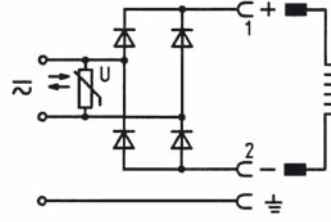

Dimensions [mm]

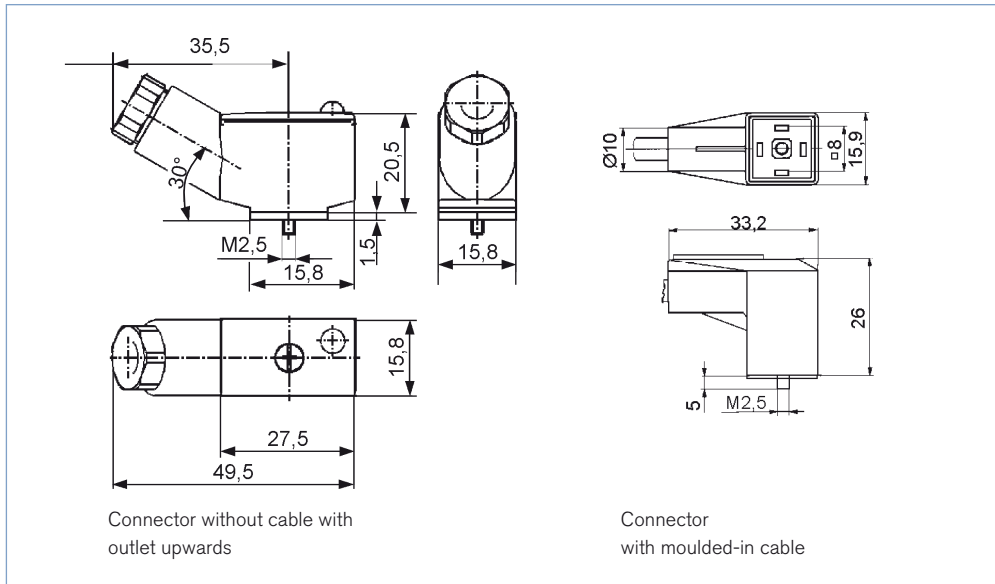

DTS 1000010985 EN Version: F Status: RL (released | freigegeben | valide) printed: 29.08.2013

To find your nearest Bürkert facility, click on the orange box → www.burkert.com

In case of special application conditions, please consult for advice.

Subject to alteration.
© Christian Bürkert GmbH & Co. KG

1302/3_EU-en_00891682