



- Compact design in 3 and 4-way versions
- Extendable valve block
- Reduced power consumption
- High cycle rocker pilot
- Different pneumatic connections available
- Approvals: 

Type 5470 R can be combined with...



Type 2506
Cable plug



Type 2510/2511
ASI cable plug



Type 2012
Single-seat
globe valve

The Type 5470 R is available as a 3/2 and 4/2-way valve. Unique modular design allows valve banks to be easily assembled. Valves can be assembled, removed or replaced in a snap. Different variations are available for service ports 2 and 4.

Technical data	
Orifice	DN 4.0 mm
Body material	Polyamide (PA)
Valve internal	Ultramide
Seal material	NBR
Media	Compressed air, neutral gases (5 µm filtering)
Media temperature	+14 to 122 °F (-10 to +50 °C)
Ambient temperature	+14 to 131 °F (-10 to +55 °C)
Supply connections 1, 3	Module flange
Service port 2 and 4	Threaded port NPT 1/8
Options	Push-in connection Ø 1/4
Voltage tolerance	±10%
Power consumption	2W, 3W (Refer to the effective coil power in the ordering chart)
Duty cycle	100% continuous operation
Electrical connection	Tag connector above acc. to DIN 43650 Form C for cable plug type 2506 and Rectangular plug (5.08 mm) Type 2505
Type of protection	EEX ia IIC T6 on request, FM
Protection class	IP 65 with cable plug IP 20 at type 1057-SA and IP 40 at rectangular plug (5.08 mm)
Installation	As required, preferably with actuator upright
Approvals	UL recognized

Burkert Contromatic USA
2602 McGaw Avenue
Irvine, CA 92614
Tel. 949.223.3100
Fax 949.223.3198
www.burkert-usa.com

Burkert Contromatic Inc.
760 Pacific Road, Unit 3
Oakville, Ontario, Canada L6L 6M5
Tel. 905.847.5566
Fax 905.847.9006
www.burkert.ca

Valve with spade electrical connection on top dimensions [mm]

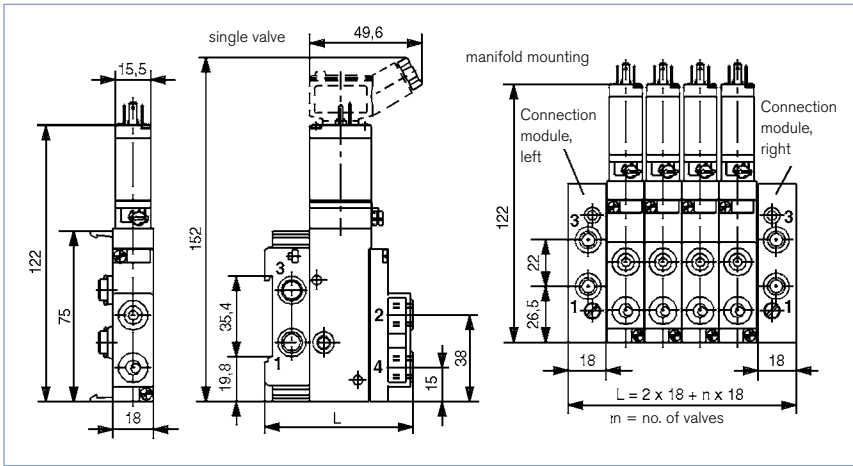

Valve with rectangular plug on the side dimensions [mm]

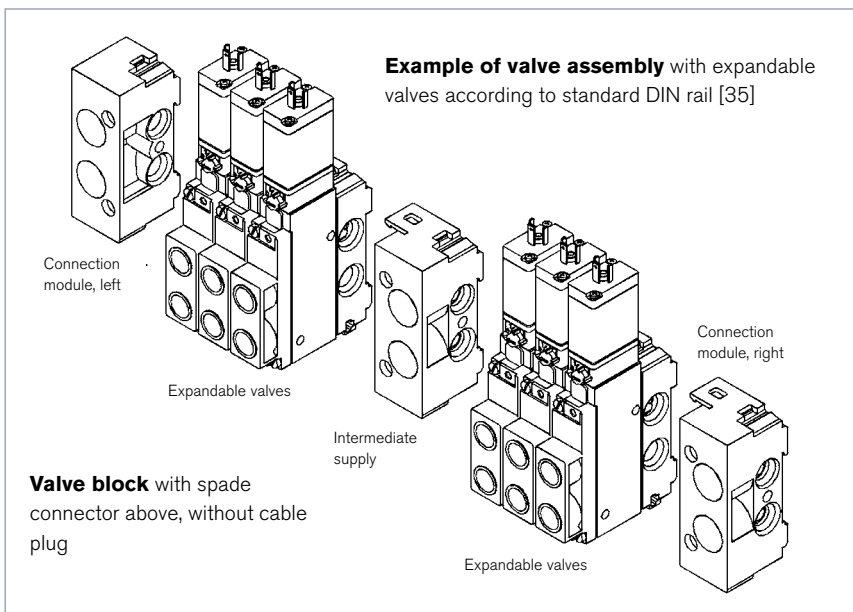
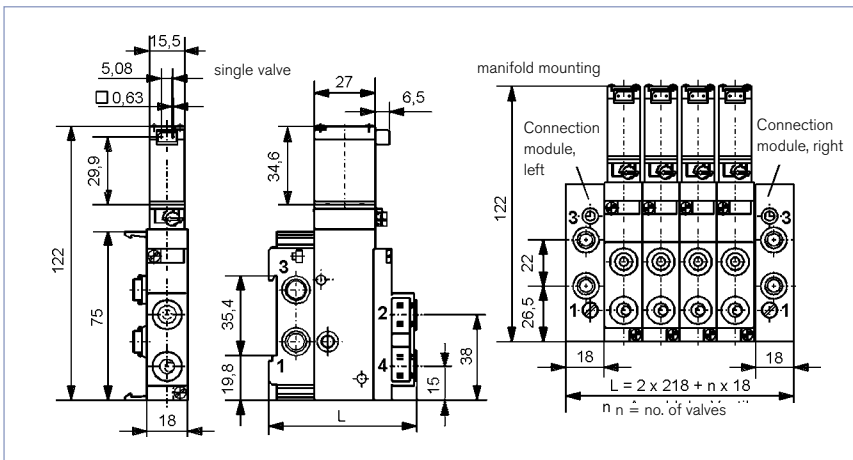

DTS 1000082439 EN Version: A Status: RL (released | freigegeben | valide) printed: 20.01.2015

Options for service port

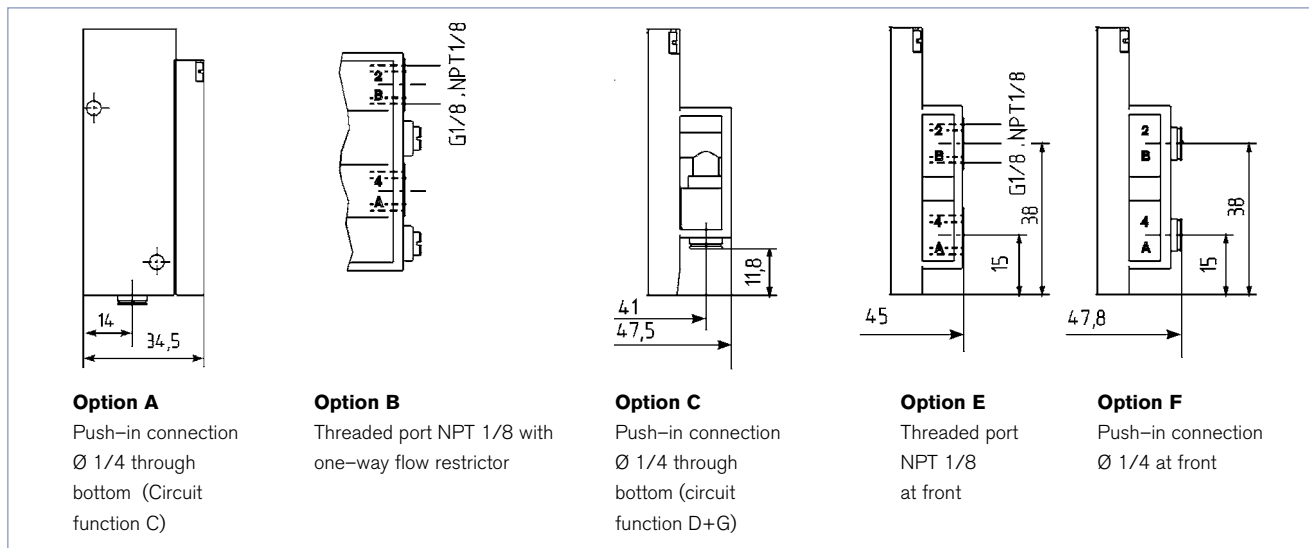

Ordering chart for valves (other versions on request)

Extendable single valve with module connection for supply ports 1 and 3, spade electrical connector on top, supplied without cable plug (see Accessories)

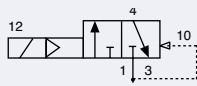
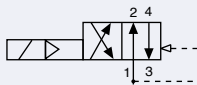
Circuit function	Orifice [mm]	Cv	Q _N value air [l/min]	Pressure range [PSI]	Service port 2 and 4	Voltage/frequency [V/Hz]	Effective coil power [W]	Item no. ■ UC coil
C 3/2-way valve, NC ■ 	4.0	.32	300	29 - 145	Push-in connection Ø 1/4 in, below with check valve (option A)	024/DC/UC	2	458 398 L
						110-120/DC/UC	3	458 399 M
						220-240/DC/UC	3	458 400 K
G 4/2-way valve 	4.0	.32	300	29 - 145	NPT 1/8 in front (option E)	024/DC/UC	2	458 880 C
					NPT 1/8 in front with one-way flow restrictor (option B)	110-120/DC/UC	3	458 881 Z
						220-240/DC/UC	3	458 882 S
						024/DC/UC	2	458 884 U
					Push-in connection Ø 1/4 through bottom (option C)	110-120/DC/UC	3	458 885 V
						220-240/DC/UC	3	458 886 W
						024/DC/UC	2	458 825 Y
110-120/DC/UC	3	458 826 Z						
220-240/DC/UC	3	458 827 S						

3/2-way models, circuit function D (NO) on request

- 3/2-way models (circuit functions C and D) with non-return valve in the module flange
- ■ For universal current operation (UC = DC or AC); rectifier, varistor and LED integrated into the coil

Ordering charts for accessories (Connector modules and accessories for valve blocks, see drawing of block assembly)

Version	Port connection	Order no. DC coil
Connector module, left	NPT 1/4	132 513
Connector module, right	NPT 1/4	132 515

Additional accessories

Accessory part	Item no.
Rectangular connector, matrix 5.08 mm, with 3 m cable	133 486
Rectangular connector, matrix 5.08 mm, with 300 mm wires	644 068
Rectangular connector, matrix 5.08 mm, with 2 single contacts	644 067
Standard rail 12 in for 8 – 12 manifold station with intermediate supply or 8 – 14 manifold station without intermediate supply	640 789 W
Standard rail 18 in for 13 – 17 manifold station with intermediate supply or 15 – 19 manifold station without intermediate supply	640 788 V
Standard rail 19 in for 17 – 22 manifold station with 2 intermediate supplies or 18 – 23 manifold station with 1 intermediate supply	630 579 R

Cable plug accessories

Accessory part	Description	Item no.
Cable plug Type 2506 ¹⁾	without circuit, 0 – 250 V	008 353 P
Cable plug Type 2506 ¹⁾	with LED, 12 – 24 V	008 402 A
Cable plug Type 2506 ¹⁾	with LED and varistor, 12 – 24 V	008 408 Q
Cable plug Type 2506 ¹⁾	with LED, rectifier and varistor, 12 – 24 V	008 354 Q
Cable plug Type 2506 ¹⁾	with LED, rectifier and varistor, 120 – 120 V	008 355 R
Cable plug Type 2506 ¹⁾	with LED, rectifier and varistor, 200 – 240 V	008 356 J

1) With these accessories, only a partial list of possible cable plugs with built-in circuit functions are mentioned. For other versions see data sheet Type 2506.
A flat seal and a mounting screw are standard with each cable plug.