

Electromagnetic Flowmeter



Type 8045 can be combined with



Type S020
INSERTION
T-Fitting

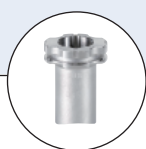

Type S020
Spigot



Type 2030
Diaphragm valve

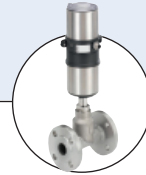

Type 8802-GD
TopControl System

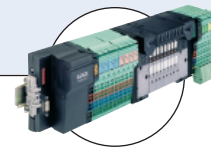

Type 8644
Valve islands with
electronic I/O

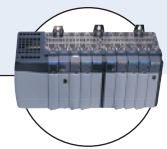

PLC

- Sensor without moving parts
- Indicates both flow rate and volume
- Simulation of all output signals
- Clean in place (CIP), FDA or KTW approved material
- Version with Alloy C22 electrodes

The electromagnetic flowmeter Type 8045 is designed for pipes with diameter sizes ranging from DN06 to DN400 and is intended exclusively to measure flow rate in neutral and slightly aggressive liquids having a conductivity more than 20 $\mu\text{S}/\text{cm}$.

The flowmeter has a backlit display, a keyboard and is equipped with a 4... 20 mA current output, a digital output (pulse output by default) and two totalizers. Some versions are equipped with two relay outputs and one digital input.

It is a magmeter made up of an electronic module and a sensor which armature material is PVDF or stainless steel. It is available:

- with G2" connection for the version with a PVDF sensor
- with G2" or clamp connection for the version with a stainless steel sensor.

The version with a stainless steel sensor has been designed for applications with high pressures (PN16) and high temperatures (up to 110°C).

The version with Alloy C22 electrodes has been designed for applications with aggressive fluids (chemicals) and especially sea water applications.

Technical data

General data

Compatibility

mit Fittings S020 (siehe entsprechendes Datenblatt)

Materials

Housing, cover, nut / seal
 PVDF sensor version
 Stainless steel sensor version
 Front panel foil
 Protection lid / seal
 PVDF sensor version
 Stainless steel sensor version
 Screws / Seal
 Cable glands
 Wetted parts material
 Sensor holder
 Electrodes
 Seals

Earth ring (PVDF sensor version)
 Electrode holder (St. Steel sensor version)

PC (glass fibre reinforced for housing) / NBR
 Black PPA (glass fibre reinforced) / NBR
 Polyester

PC / silicone
 PSU / silicone
 Stainless steel / NBR
 PA with neoprene seal

PVDF or Stainless steel 1.4404/316L
 Stainless steel 1.4404/316L or Alloy C22
 G2" connection: FKM (FDA approved) [EPDM (KTW approved)]
 Clamp connection: EPDM or FEP (to be ordered separately)
 Stainless steel 1.4404/316L or Alloy C22
 PEEK (FDA approved)

Surface finishing quality

Ra < 0.8 μm (Clamp connection)

Electrical connections

2 cable glands M20 x 1.5

Recommended cable

0.5 to 1.5 mm² cross-section, shielded cable,
 6... 12 mm diameter (if only one cable is used per cable gland) OR
 4 mm diameter (if two cables are used per cable gland with using the supplied multi-way seal)

Environment

Ambient temperature

-10 to +60°C (14 to 140°F) (operating)
 -20 to +60°C (-4 to 140°F) (storage)

Relative humidity

< 85%, without condensation

Height above sea level

max. 2000 m

Complete device data (Fitting S020 + flowmeter)	
Pipe diameter	
G2" connection	DN06 to DN400
Clamp connection	DN32 to DN100
Measuring range	0.2 to 10 m/s
Sensor element	Electrodes
Medium temperature	see Pressure/Temperature diagram
PVDF sensor version	0 to 80°C (32 to 176°F) (depends on fitting)
Stainless steel sensor version	-15 to 110°C (5 to 230°F) (depends on fitting)
Medium pressure max.	see Pressure/Temperature diagram
PVDF sensor version	PN10 (145.1 PSI)
Stainless steel sensor version	PN10 (145.1 PSI) (with plastic fitting) - PN16 (232.16 PSI) (with metal fitting)
Conductivity	min. 20 µS/cm
Accuracy	
Teach-In	±0.5% of Reading ¹⁾ (at the teach flow rate value)
Standard K-factor	±3.5% of Reading ¹⁾
Linearity	±0.5% of F.S. ¹⁾
Repeatability	±0.25% of Reading ¹⁾

¹⁾ Under reference conditions i.e. measuring fluid=water, ambient and water temperature = 20°C (68°F), applying the minimum inlet and outlet straight pipe lengths, matched inside pipe dimensions.

* F.S.= of Full scale (10 m/s)

Electrical data	
Operating voltage	18 - 36 V DC filtered and regulated (3 wires) Tolerance: ±0.5%
Reversed polarity of DC	protected
Current consumption	≤ 300 mA (at 18 V DC)
Digital input DI1	Supply voltage: 18 - 36 V DC, input impedance 15 kΩ min. pulse duration: 200 ms Galvanic insulation, protected against polarity reversals of DC and voltage spikes
Digital outputs	
Transistor (DO1)	Type: NPN or PNP (wiring dependent), open collector Function: pulse output (by default), user configurable 0 - 250 Hz, 5 - 36 V DC, 100 mA max., duty cycle if frequency > 2 Hz: 1/2; min. pulse duration if frequency < 2 Hz: 250 ms Galvanic insulation, protected against polarity reversals of DC and short-circuits
Relay (DO2 and DO3)	2 normally open relays, freely adjustable (hysteresis by default), 250 V AC/3 A or 30 V DC/3 A (resistive load), max. cutting power of 750 VA (resistive load); life span of min. 100000 cycles
Analogue output	
Current (AO1)	4... 20 mA, sink or source (wiring dependent), 22 mA to indicate a fault max. loop impedance: 1300 Ω at 36 V DC, 1000 Ω at 30 V DC, 700 Ω at 24 V DC, 450 Ω at 18 V DC
4... 20 mA output accuracy	±1%

Standards, directives and approvals	
Protection class	IP65, device wired and cable glands tightened and lid screwed tight
Standards and directives	
EMC	EN 61000-6-2, EN 61000-6-3
Low voltage (LVD)	EN 61010-1
Pressure	Complying with article 3 of §3 from 97/23/CE directive.*
Vibration	EN 60068-2-6
Shock	EN 60068-2-27
Approvals	FDA (only for device with FKM seal and PEEK electrode holder) KTW (only for device with EPDM seal and PVDF sensor holder) Available version with CSA-Approved for US and Canada  on request

* For the 97/23/CE pressure directive, the device can only be used under following conditions (dependent on max. pressure, pipe diameter and fluid).

Type of fluid	Conditions
Fluid group 1, §1.3.a	Forbidden
Fluid group 2, §1.3.a	DN ≤ 32, or DN > 32 and PN*DN ≤ 1000
Fluid group 1, §1.3.b	PN*DN ≤ 2000
Fluid group 2, §1.3.b	DN ≤ 200 or PN ≤ 10 or PN*DN ≤ 5000

Pressure/Temperature diagram

Please be aware of the fluid pressure/temperature dependence according to the respective fitting + flowmeter material as shown in the diagrams.

8045 with a PVDF sensor

(depending on the fitting material)

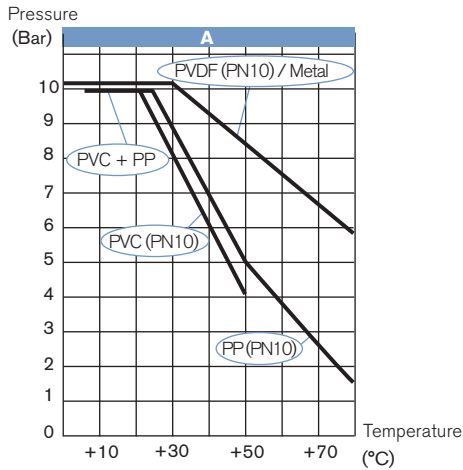

8045 with a stainless steel sensor

(depending on the fitting material)

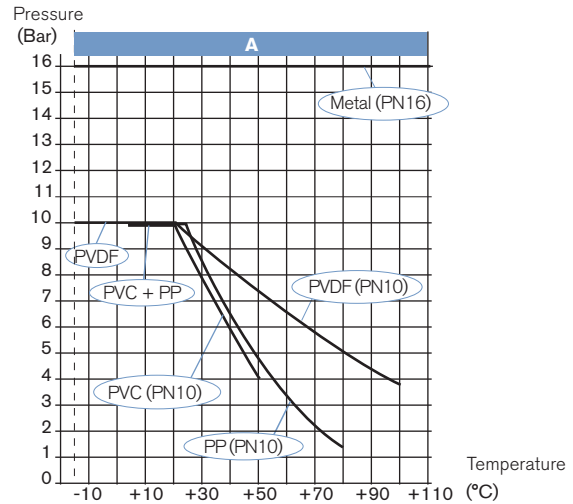

A: Application range for complete device (fitting + flowmeter)

Software main features

- Choice of the display language
- International measuring units
- Teach-In for a better accuracy, or K-factor setting
- 4... 20 mA current output (AO1)
- Transistor output (DO1)
- 2 relays (DO2 and DO3 - if equipped)
- Detection of flow direction possible
- ON/OFF digital input (DI1 - if equipped)
- Filter function
- Reset both totalizers (main and daily)
- Low flow "Cut-Off"
- Brightness of the display
- Password for parameter settings
- Warning and fault messages generating
- Simulation mode to adjust Zero and Span and simulate flow in dry-run condition

Possible applications

Flow control of conductive fluids, contaminated or not:

- ▶ Waste water treatment
- ▶ Flow control of drinking water (FDA approval)
- ▶ Laundries: measurement and control of the water consumption
- ▶ Swimming pools: pump protection and flow control
- ▶ Food-processing industry: monitoring of the cleaning cycles (FDA approval)
- ▶ Irrigation
- ▶ Application with sea water: desalination, fish farms

Design

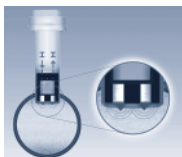

The magnetic system inside the sensor induces a magnetic field into the fluid, which is perpendicular to the direction of flow. Two electrodes are in galvanic contact with the liquid. Based on the Faraday law a voltage can be measured between these electrodes once a liquid (min. conductivity of 20 $\mu\text{S}/\text{cm}$) flows along the pipe.

This voltage is proportional to the flow velocity.

Using the K-factor for the individual pipe diameter the speed of flow is converted into volume per time.

Description of the navigation keys and the status LEDs

- Scrolling up the parameters within a level or a menu
- Increase the figure selected

Device status LED: see following table

- Scrolling down the parameters within a level or a menu
- Selecting the figure on the left
- Reading the messages in the information menu

Large digital display with 8 characters (4 digital characters and 4 alphanumeric characters) indicating:

- the measured flow
- the value of the current output
- the value of the main totalizer
- the value of the daily totalizer

- Selecting the displayed parameters
- Validating the settings

Status LED of relay DO3 (LED ON = contact closed)

Status LED of relay DO2 (LED ON = contact closed)

Device status LED	Status of the device
Green	The device operates correctly
Orange	A warning messages is generated in the information menu.
Red	A fault message is generated and a 22 mA current is sent on the current output.
Blinking, whatever the colour	<ul style="list-style-type: none"> The DI1 digital input is active or a check for the correct behaviour of the outputs is running or a flow zero point calibration procedure is running or the daily totalizer is kept at zero

Installation

The 8045 can easily be installed into any Bürkert INSERTION fitting system (S020) by just fixing the main nut. Minimum straight upstream and downstream distances must be observed. According to the pipe's design, necessary distances can be bigger or use a flow conditioner to obtain the best accuracy. For more information, please refer to EN ISO 5167-1.

EN ISO 5167-1 prescribes the straight inlet and outlet distances that must be complied with when installing fittings in pipe lines in order to achieve calm flow conditions. The most important layouts that could lead to turbulence in the flow are shown below, together with the associated prescribed minimum inlet and outlet distances. These ensure calm, problem-free measurement conditions at the measurement point.

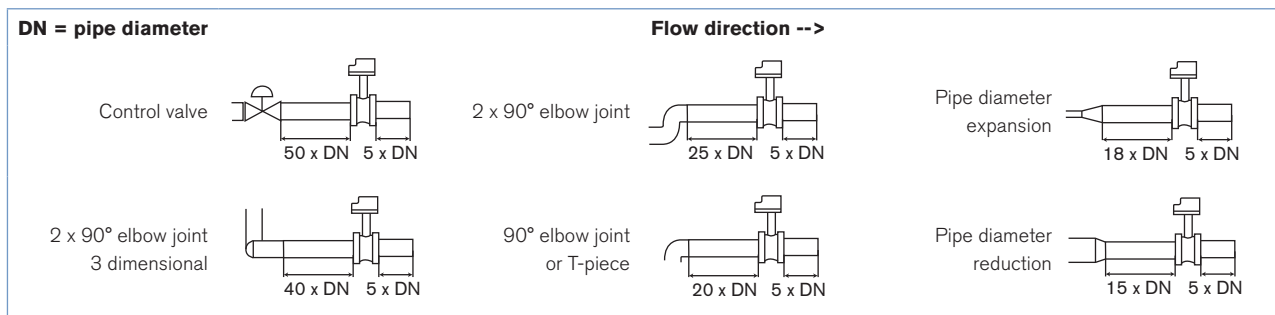

It is advisable to mount the flowmeter at a 45° angle to the horizontal centre of the pipe to avoid having deposits on the electrodes and false measurements due to air bubbles

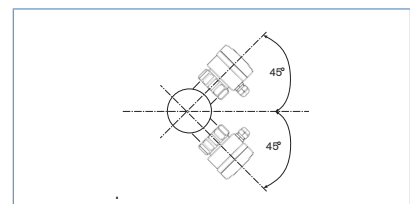

Installation (continued)

The device can be installed into either horizontal or vertical pipes. Mount the 8045 in the following correct ways to obtain an accurate flow measurement.

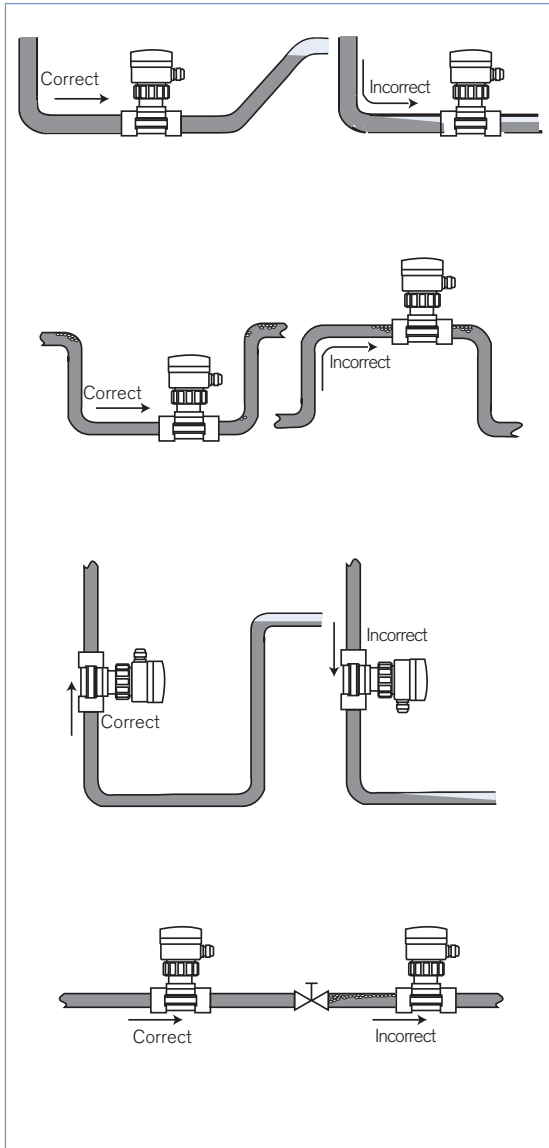

Pressure and temperature ratings must be in accordance to the selected fitting material. The suitable pipe size is selected using the diagram Flow/Velocity/DN.

The flowmeter is not designed for gas or steam flow measurement.

Diagram Flow/Velocity/DN

Example:

- Flow: 10 m³/h
- Ideal flow velocity: 2...3 m/s

For these specifications, the diagram indicates a pipe size of DN40 [or DN50 for (*) mentioned fittings]

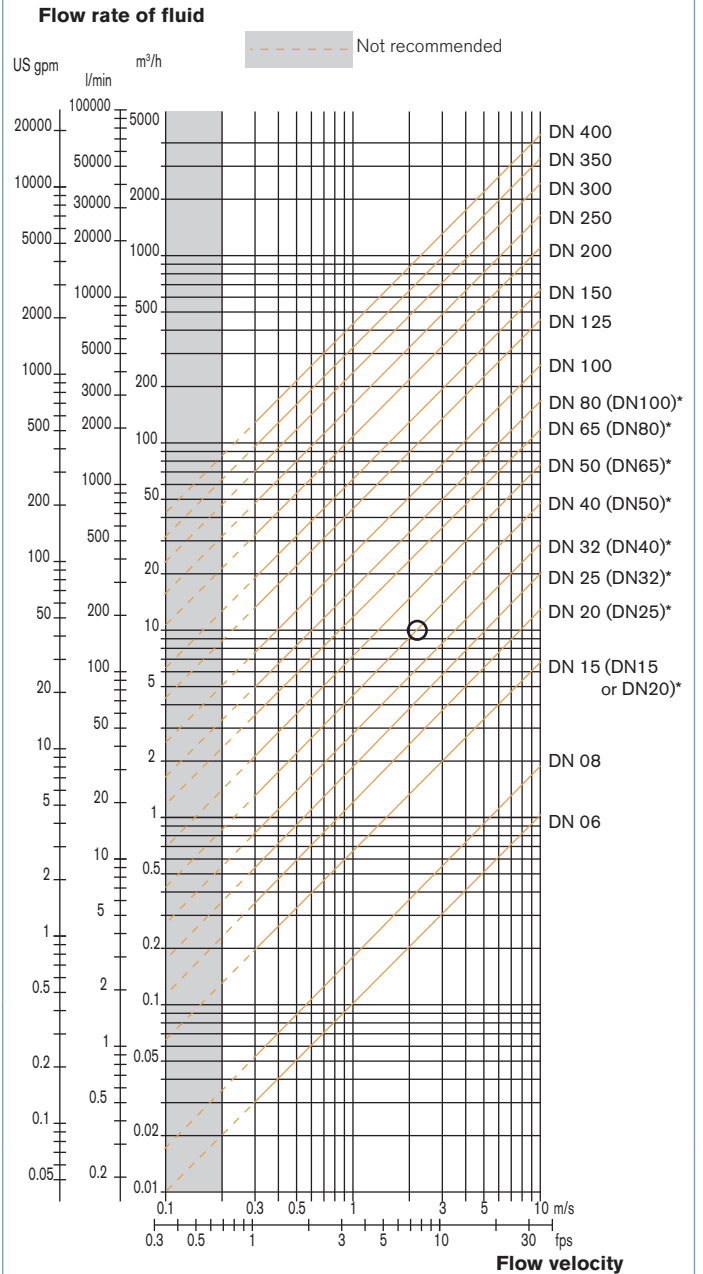

* for following fittings with process connection:
 ▪ external thread acc. to SMS 1145
 ▪ weld end acc. to SMS 3008, BS 4825/ASME BPE or DIN 11850 Series 2
 ▪ Clamp acc. to SMS 3017/ISO 2852, BS 4825/ASME BPE or DIN 32676

Dimensions [mm]

G2" connection version

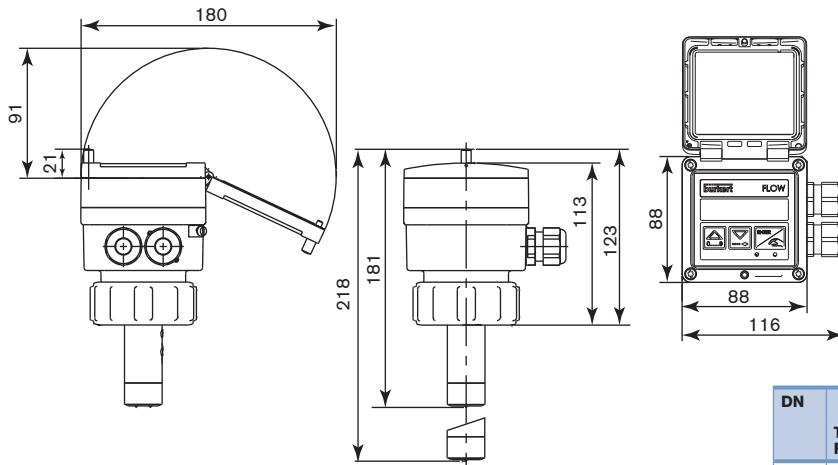

Note: The length of the sensor finger depends on the fitting used. See data sheet Type S020 or available fitting DN diagram on next page 9.

DN	H			
	T-Fitting	Saddle	Plastic spigot	Metal spigot
06	182			
08	182			
15	187			
20	185			
25	185			
32	188			
40	192			188
50	198	223		193
65	198	222	206	199
80		226	212	204
100		231	219	214
110		227		
125		234	254	225
150		244	261	236
180		268		
200		280	282	257
250			300	317
300			312	336
350			325	348
400			340	

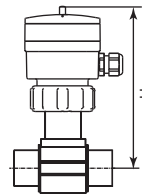

Clamp connection version

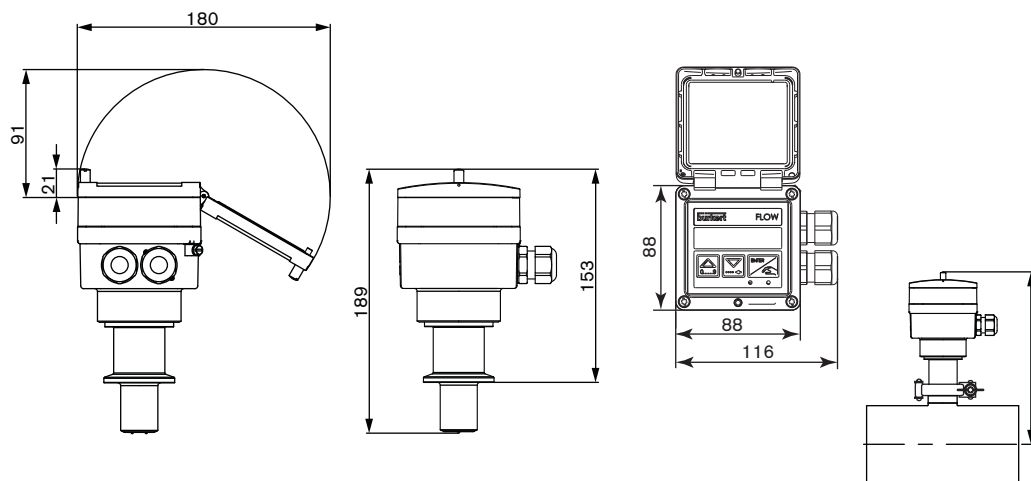

DN	H
32	200
40	205
50	210
65	218
80	224
100	230

Ordering information and chart for flowmeter Type 8045

• G2" connection to use with S020 Fitting for flowmeter with G2" connection.

A complete flowmeter Type 8045 with G2" connection consists of a flowmeter Type 8045 (with G2" connection) and a Bürkert fitting Type S020.

The following information is necessary for the selection of a complete device:

- **Item no.** of the desired flowmeter **Type 8045** (see ordering chart, below)
- **Item no.** of the selected fitting **Type S020** for flowmeter with G2" connection (see separate data sheet) [More info.](#)

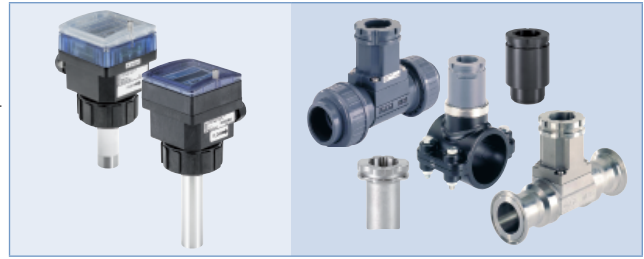

All these versions have as minimum

- a 4... 20 mA current output (AO1) and
- a digital output (DO1)

Operating voltage	Digital input	Relay output	Housing material	Seal	Sensor version	Electrode material	Electrical connection	Item no.
18 - 36 V DC	No	No	PC	FKM	Short, PVDF	Stainless steel	2 cable glands M20 x 1.5	426 498
					Long, PVDF	Stainless steel	2 cable glands M20 x 1.5	426 499
	1 (DI1)	2 (DO2, DO3)	PC	FKM	Short, PVDF	Stainless steel	2 cable glands M20 x 1.5	426 506
					Long, PVDF	Stainless steel	2 cable glands M20 x 1.5	426 507
	No	Nein No	PPA	FKM	Short, st. steel (FDA)	Stainless steel	2 cable glands M20 x 1.5	449 670
					Long, st. steel (FDA)	Stainless steel	2 cable glands M20 x 1.5	449 672
	1 (DI1)	2 (DO2, DO3)	PPA	FKM	Short, st. steel (FDA)	Stainless steel	2 cable glands M20 x 1.5	449 671
					Long, st. steel (FDA)	Stainless steel	2 cable glands M20 x 1.5	449 673
	No	No	PC	FKM	Short, PVDF	Alloy C22	2 cable glands M20 x 1.5	558 675
					Long, PVDF	Alloy C22	2 cable glands M20 x 1.5	558 676

Note: 1 EPDM seal contained in the kit 551775 is supplied with each flowmeter.

• Clamp connection to use with S020 Fitting for flowmeter with clamp connection.

A complete flowmeter Type 8045 with clamp connection consists of a flowmeter Type 8045 (with clamp connection), a Bürkert fitting Type S020, a clamp collar and a fitting/flowmeter seal.

The following information is necessary for the selection of a complete device:

- **Item no.** of the desired flowmeter **Type 8045** (see ordering chart, below)
- **Item no.** of the selected fitting **Type S020** for flowmeter with clamp connection (see separate data sheet) [More info.](#)
- **Item no.** of the selected fitting/flowmeter seal - EPDM or FEP (see ordering chart, p. 8)
- **Item no.** of the clamp collar (see ordering chart, p. 8)

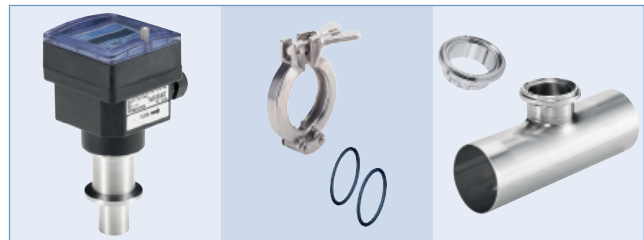

All these versions have as minimum

- a 4... 20 mA current output (AO1) and
- a digital output (DO1)

Operating voltage	Digital input	Relay output	Housing material	Fitting/flowmeter seal*	Sensor version	Electrode material	Electrical connection	Item no.
18 - 36 V DC	No	No	PPA	EPDM or FEP	Clamp, Stainless steel (FDA)	Stainless steel	2 cable glands M20 x 1.5	564 797
	1 (DI1)	2 (DO2, DO3)	PPA	EPDM or FEP	Clamp, Stainless steel (FDA)	Stainless steel	2 cable glands M20 x 1.5	564 798





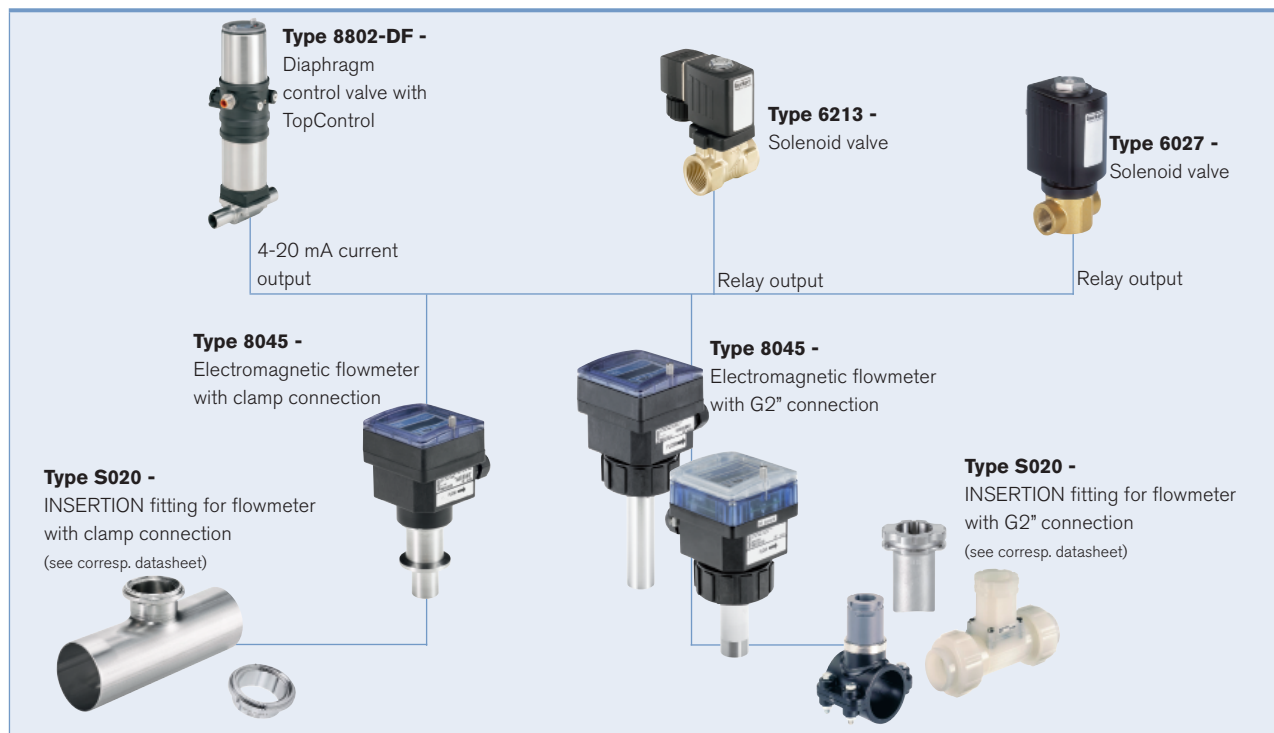

Note: 1 Kit 565384 is supplied with each flowmeter.

• **Has to be ordered separately**

Ordering chart - accessories for flowmeter Type 8045 (has to be ordered separately)

Specifications	Item no.
Set with 2 cable glands M20 x 1.5 + 2 neoprene flat seals for cable gland or plug + 2 screw-plugs M20 x 1.5 + 2 multiway seals 2 x 6 mm	449 755
Set with 2 reductions M20 x 1.5 /NPT1/2" + 2 neoprene flat seals for cable gland or plug + 2 screw-plugs M20 x 1.5	551 782
3 points calibration certificate (device combined with a S020 fitting, only for DN ≤ 200)	550 676
FDA - Approval (only stainless steel sensor version)	449 788
For G2" connection version	
Set with 1 stopper for unused cable gland M20 x 1.5 +1 multiway seal 2 x 6 mm for cable gland + 1 green FKM seal for the sensor + 1 mounting instruction sheet	558 102
Snap ring	619 205
PC union nut	619 204
PPA union nut	440 229
Set with 1 green FKM and 1 black EPDM seal	552 111
For clamp connection version	
Set with 1 stopper for unused cable gland M20 x 1.5 +1 multiway seal 2 x 6 mm for cable gland	565 384
1 EPDM fitting/flowmeter seal	730 837
1 FEP fitting/flowmeter seal	730 839
Clamp collar	731 164

Interconnection possibilities with other Bürkert devices

		DN06	DN08	DN32	DN50	DN65	DN100	DN200	DN350	DN400	
Available S020 fittings for flowmeter with connection	T-Fitting 	(1)		Kurzer Sensor							
	Welding socket 				Kurzer Sensor		Langer Sensor				
	G2" Fusion spigot 				Kurz Sensor		Langer Sensor				
	Screw-on 						Langer Sensor				
	Saddle 				Langer Sensor						
	Clamp	T-Fitting 									
		Welding socket 									

⁽¹⁾ DN06 and DN08 in stainless steel S020 only, 8045 with stainless steel sensor recommended

DTS 1000011093 EN Version: Y Status: RL (released | freigegeben | valide) printed: 16.06.2014

To find your nearest Bürkert office, click on the orange box →

www.burkert.com

In case of special application conditions, please consult for advice.

Subject to alteration.
© Christian Bürkert GmbH & Co. KG

1406/17_EU-en_00891790