

Inductive conductivity meter

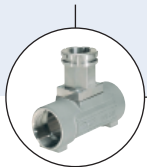

- Configurable outputs: up to 2 transistor and up to 2 analog 4... 20 mA outputs
- Removable backlighted display
- Simulation of process values
- Diagnostic functions
- Sensor-versions available with PEEK, PVDF or PP

Type 8228 can be combined with...



Type S020
INSERTION fitting



Type 8802-DF
Diaphragm valve with control unit



Type 2030
On/Off Diaphragm valve



Type 8619
multiCELL Transmitter/Controller

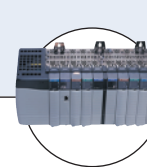

PLC

Bürkert's analytical meter Type 8228 is designed for measuring the conductivity in industrial and water treatment applications (i.e. aggressive fluids, CIP, ...).

The conductivity meter consists of a sensor, plugged-in and pinned to an enclosure with cover, containing the transmitter module and a removable display. The sensor component consists of a pair of magnetic coils in a PP, PVDF or PEEK holder. The cell constant is an average value over the whole measuring range. It can be re-adjusted depending on application. The integrated temperature probe (without direct contact to the fluid) for automatic compensation is a standard feature in the conductivity sensor holder.

The conductivity meter can operate independent of the display but it will be required for programming the device (i.e. selection of sensor cell constant, language, measuring range, engineering units, calibration...) and also for visualizing continuously the measured and processed data.

The device Type 8228 is available:



- with two fully configurable outputs: one transistor and one 3-wire 4... 20 mA current outputs
- with four fully configurable outputs: two transistor and two 3-wire 4... 20 mA current outputs.

The electronics of Type 8228 converts the measured signal, displays different values in different physical units (if display mounted) and computes the output signals, which are provided via one or two M12 fixed connectors.

Complete device data (Fitting + conductivity meter)	
Pipe diameter	DN15 to 400
Conductivity measurement	
Measuring range	100 µS/cm...2 S/cm
Resolution	0.1 µS/cm
Measurement deviation ("measurement bias" as defined in the standard JCGM 200:2012)	±(2% of the measured value + 5 µS/cm)
Linearity	±2%
Repeatability	±(0.2% of the measured value + 2 µS/cm)
Response time t90	from 3 s (without filter) to 40 s (with slow filter)
Temperature measurement	
Measuring range	-40 to +150°C (-40 to 302°F)
Resolution	0.1°C (0.18°F)
Measuring uncertainty	±1°C (1.8°F)
Response time t90	< 280 s (without filter)
Temperature compensation	- none or - according to a predefined graph (NaCl, NaOH, HNO ₃ or H ₂ SO ₄) or - according to a graph defined especially for your process
Medium temperature with conductivity sensor in	
PVDF	-15 to +100 °C (5 to 212°F)
PP	0 to +80 °C (32 to 176°F)
PEEK	-15 to 130°C (5 to 266°F)
Temperature limits may depend on the material the S020 fitting used is made of. Refer to the relevant data sheet or instruction manual and the pressure/temperature diagram of the fluid on page 3. If the temperature ranges given for the device and the fitting are different, use the most restrictive range.	
Fluid pressure max with conductivity sensor in	
PVDF, PP	PN6 (87 PSI)
PEEK	PN10 (145 PSI)
Pressure limits may depend on the material the S020 fitting used is made of. Refer to the relevant data sheet or instruction manual and the pressure/temperature diagram of the fluid on page 3. If the temperature ranges given for the device and the fitting are different, use the most restrictive range.	

**8228
ELEMENT**

bürkert

Environment	
Ambient temperature	-10 to +60°C (14 to 140°F) (operating and storage)
Relative humidity	≤ 85%, without condensation
Height above sea level	Max. 2000 m
General data	
Compatibility	Any pipe which are fitted out with Bürkert INSERTION Fitting S020 (see corresponding data sheet)
Materials	See materials view, on next page
Housing / Cover	Stainless steel 1.4404, PPS / PC
Seal / Screws	EPDM / Stainless steel
Fixed connector holder	Stainless steel 1.4404 (316L)
M12 fixed connector	Brass nickel plated
Display / Navigation key	PC / PBT
Nut	PC
Wetted part materials	
Sensor holder	PP, PVDF or PEEK
Seal	FKM (standard) or EPDM (option)
Temperature sensor	Integrated in the sensor
Display (accessories)	Grey dot matrix 128x64 with backlighting
Electrical connections	
2 outputs meter (3-wire)	1x 5-pin M12 male fixed connector,
4 outputs meter (3-wire)	1x 5-pin M12 male + 1x 5-pin M12 female fixed connectors
Connection cable	Shielded cable, ø 3 to 6.5 mm; max. 0.75 mm ² cross section
Electrical data	
Supply voltage	12 - 36 V DC, ±10% oscillation rate, filtered and regulated, SELV (safety extra low voltage) circuit with a non dangerous energy level
Current consumption with sensor	≤ 25 mA (at 12 V DC and without the consumption of the 4... 20 mA output)
Reversed polarity of DC	Protected
Voltage peak	Protected
Short circuit	Protected
Output	
Transistor	Polarized, galvanically insulated configurable through wiring and through parameterizing as sourcing (PNP) or sinking (NPN) output NPN: 1 - 36 V DC, max. 700 mA (or 500 mA max. per transistor if both transistor outputs are wired) output PNP: V+ supply voltage, max. 700 mA (or 500 mA max. per transistor if both transistor outputs are wired)
Current (3-wire)	4... 20 mA configurable through wiring and through parameterizing as sourcing or sinking, 22 mA to indicate a fault (can be parametered) max. loop impedance: 1100 Ω at 36 V DC; 610 Ω at 24 V DC; 100 Ω at 12 V DC
Uncertainty of the output value	1% of the full scale
Response time (10% - 90%)	150 ms (default value)
Standards, directives and approvals	
Protection class acc. to EN 60529	IP65 and IP67 with M12 connectors plugged in and tightened and electronic module cover fully screwed down
Standard and directives 	
EMC	EN 61000-6-2, EN 61000-6-3 and Annex1, EN 61326-1-7 (Table 2)
Pressure	Complying with article 3 of §3 from 97/23/CE directive.*
Vibration / Shock	EN 60068-2-6 / EN 60068-2-27
Approvals	
UL-Recognized for US and Canada 	61010-1 + CRN/CSA-C22 No.61010-1
Specific technical data of UL-recognized products for US and Canada	
Intended for an inner pollution	Grade of pollution 2, according to EN61010-1
Installation category	Category I, according to UL61010-1

* For the 97/23/CE pressure directive, the device can only be used under following conditions (depend on max. pressure, pipe diameter and fluid).

Type of fluid	Conditions
Fluid group 1, §1.3.a	Forbidden
Fluid group 2, §1.3.a	DN ≤ 32, or DN > 32 and PN*DN ≤ 1000
Fluid group 1, §1.3.b	PN*DN ≤ 2000
Fluid group 2, §1.3.b	DN ≤ 200 or PN ≤ 10

Materials view

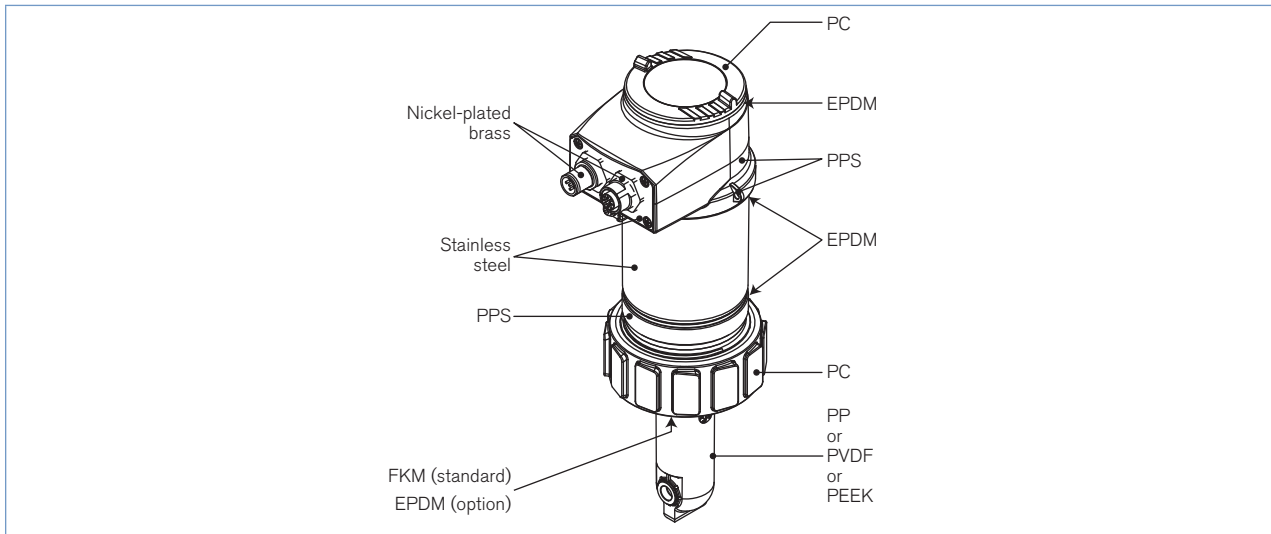

Pressure/temperature chart

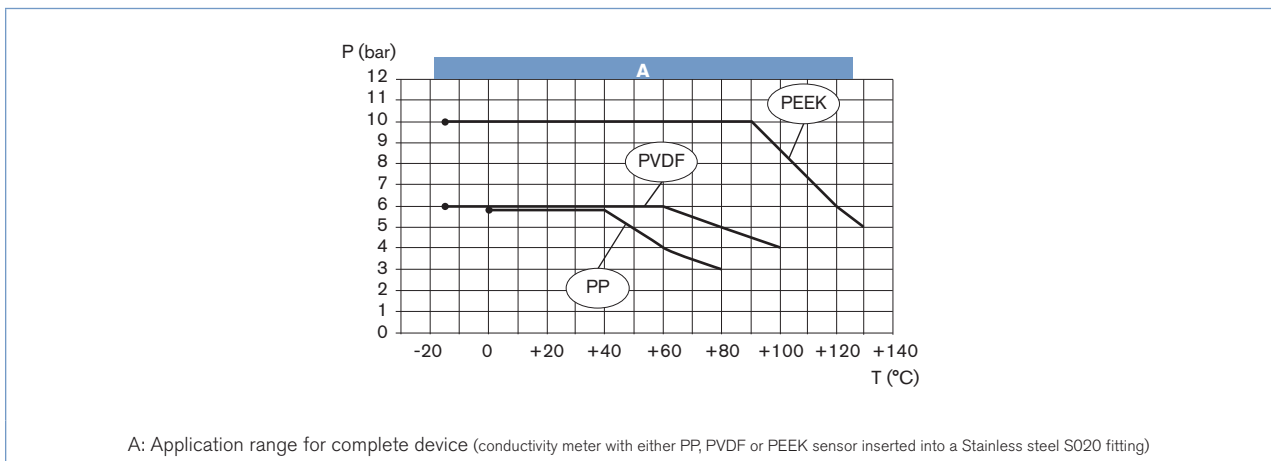

Principle of operation

The conductivity is defined as the ability of a solution to conduct electrical current. The load carriers are ions (E.G. dissolved salt or acids). In order to measure conductivity, an AC voltage source is connected to the primary magnetic coil. The magnetic field induced generates a current in the secondary magnetic coil. The intensity of this induced current is a direct function of the conductivity of the solution.

Up to two 4... 20 mA standard signal are available as output signals, proportional to the conductivity and/or to the temperature of the fluid.

The conductivity meter is a three-wire device and requires a power supply of 12 V DC up to 36 V DC.

In-line installation



The 8228 conductivity meter can be installed into any Bürkert INSERTION fitting (S020),, by just fixing the main nut.

Select and install the required fitting onto the pipe, according to specific requirements of the sensor and fitting material (temperature and pressure).

Then, carefully install the device on the fitting, and tighten with the nut. It can be installed in any position.

In order to get reliable measurement air bubbles must be avoided.

Please ensure that the mounting location provides a continuous and complete immersion of the sensor in the flow stream.

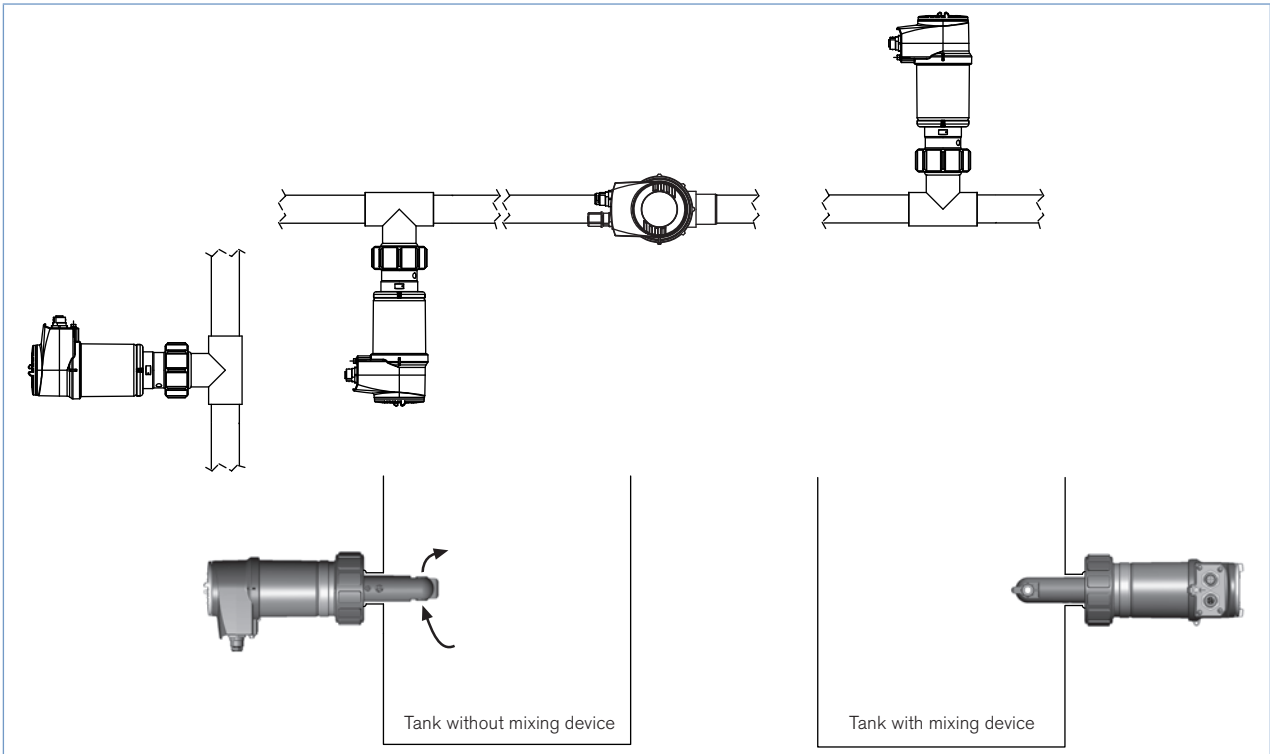

The device must be protected from constant heat radiation and other environmental influences, such as direct exposure to sunlight.

Combining the S020 with a measuring device for conductivity measurement

	DN06	DN15	DN32	DN50	DN65	DN350	DN400	
Available S020 fittings								
T-fitting for measuring device with G2" c connection	[Bar chart showing availability from DN06 to DN65]							
Welding socket					[Bar chart showing availability from DN50 to DN400]			
Fusion spigot					[Bar chart showing availability from DN65 to DN400]			
Conductivity measuring device 8228		[Bar chart showing availability from DN15 to DN400, with '***' in the DN15-32 range]						

*** Only use plastic fitting in analytical version with true union acc. to DIN 8063 (PVC), to DIN 16962 (PP) or to ISO 10931 (PVDF)

Dimensions [mm] of conductivity meter Type 8228

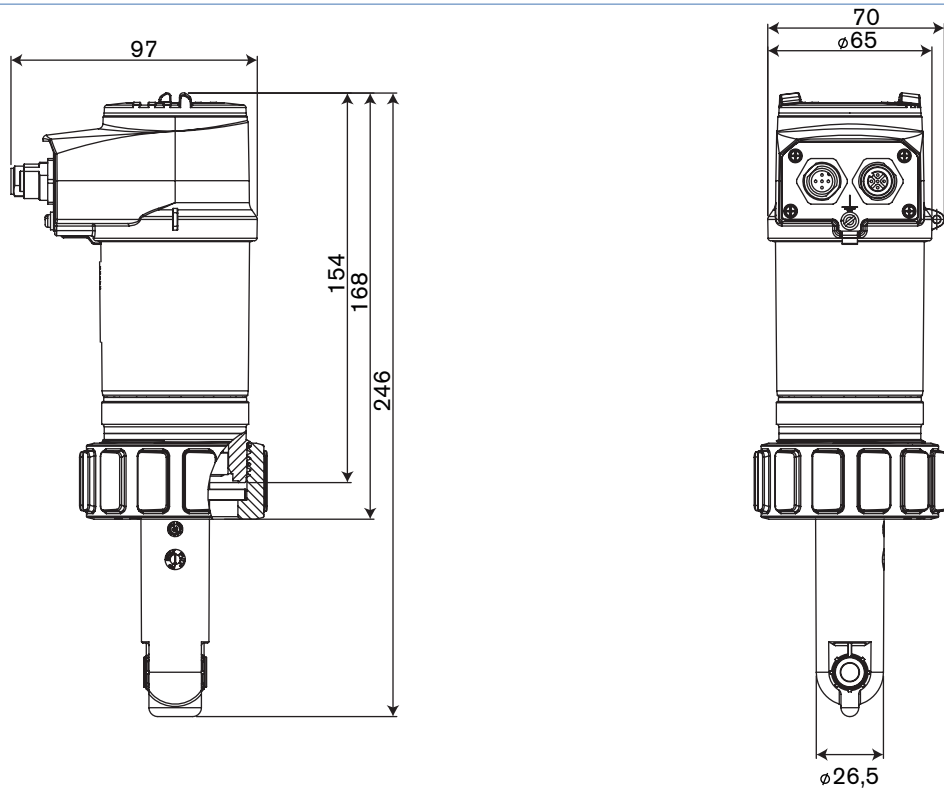

Orifice	H		
	T-Fitting	Plastic spigot	Metal spigot
15	233*		
20	233*		
25	233*		
32	233		
40	237		
50	243		238
65	243	264**	244
80		264**	249
100		264**	259
125		299	270
150		306	281
200		327	302
250		345	362
300		357	381
350		370	393
400		385	

* Only use plastic fitting in analytical version with true union acc. to DIN 8063 (PVC), to DIN 16962 (PP) or to ISO 10931 (PVDF)

** use analytical fusion spigot (Item no. 418652, 418660 or 418644 in PP, PVDF or PE) for orifice DN65-DN100

Ordering information for compact conductivity meter Type 8228

A complete compact ELEMENT conductivity meter Type 8228 consists of a compact ELEMENT conductivity meter Type 8228, a removable display/configuration module and a Bürkert INSERTION adaptor Type S020.

The following information is necessary for the selection of a complete device:

- **Item no.** of the desired ELEMENT conductivity meter **Type 8228** available with or without display/configuration module (see ordering chart on p. 7)
- **Item no.** of the selected INSERTION fitting **Type S020** (see separate data sheet)



Attention!

When you order devices without display/configuration module, please take care that you also order at least one display/configuration module for the operation. Order no. of the removable display/configuration module, see ordering chart on p. 7

When you click on the orange box "More info." below, you will come to our website for the resp. product where you can download the data sheet.

Example

Compact conductivity meter Type 8228



Removable display/configuration module (included or separately available)



+

INSERTION fitting Type S020



More info.







Complete ELEMENT device for conductivity measurement Type 8228



Fitting (example only)

Ordering chart for compact conductivity meter Type 8228





Conductivity meter Type 8228

Specifications	Voltage supply	Output	Sensor holder material	Sensor seal material*	Electrical connection	UL Approvals	Item no.** without display	Item no.** with display
Compact conductivity meter	12 - 36 V DC	1 x transistor NPN/PNP + 1 x 4... 20 mA	PP	FKM	5-pin M12 male fixed connector	No	565 601	566 601
						 UL-Recognized	565 611	566 611
			PVDF	FKM	5-pin M12 male fixed connector	No	565 603	566 603
						 UL-Recognized	565 613	566 613
			PEEK	FKM	5-pin M12 male fixed connector	No	565 605	566 605
						 UL-Recognized	565 615	566 615
		2 x transistors NPN/PNP + 2 x 4... 20 mA	PP	FKM	5-pin M12 male and 5-pin M12 female fixed connectors	No	565 602	566 602
						 UL-Recognized	565 612	566 612
			PVDF	FKM	5-pin M12 male and 5-pin M12 female fixed connectors	No	565 604	566 604
						 UL-Recognized	565 614	566 614
			PEEK	FKM	5-pin M12 male and 5-pin M12 female fixed connectors	No	565 606	566 606
						 UL-Recognized	565 616	566 616

* **FKM seal in standard;** 1 set including a green FKM and a black EPDM seals for the sensor, is supplied with each conductivity meter

** **Transparent cover** in standard

Ordering chart for accessories

Description	Item no.
Removable display/configuration module (with instruction sheet)	559 168
Black blank cover with EPDM seal	560 948
Transparent cover with EPDM seal (standard)	561 843
Ring	619 205
PC - nut	619 204
Calibration solution, 300 ml, 706 µS/cm	440 018
Calibration solution, 300 ml, 1413 µS/cm	440 019
Calibration solution, 500 ml, 12880 µS/cm	565 741
Calibration solution, 300 ml, 100 mS/cm	440 020
 5-pin M12 female straight cable plug with plastic threaded locking ring, to be wired	917 116
 5-pin M12 male straight cable plug with plastic threaded locking ring, to be wired	560 946
 5-pin M12 female straight cable plug moulded on cable (2 m, shielded)	438 680
 5-pin M12 male straight cable plug moulded on cable (2 m, shielded)	559 177

Interconnection possibilities with other Bürkert devices

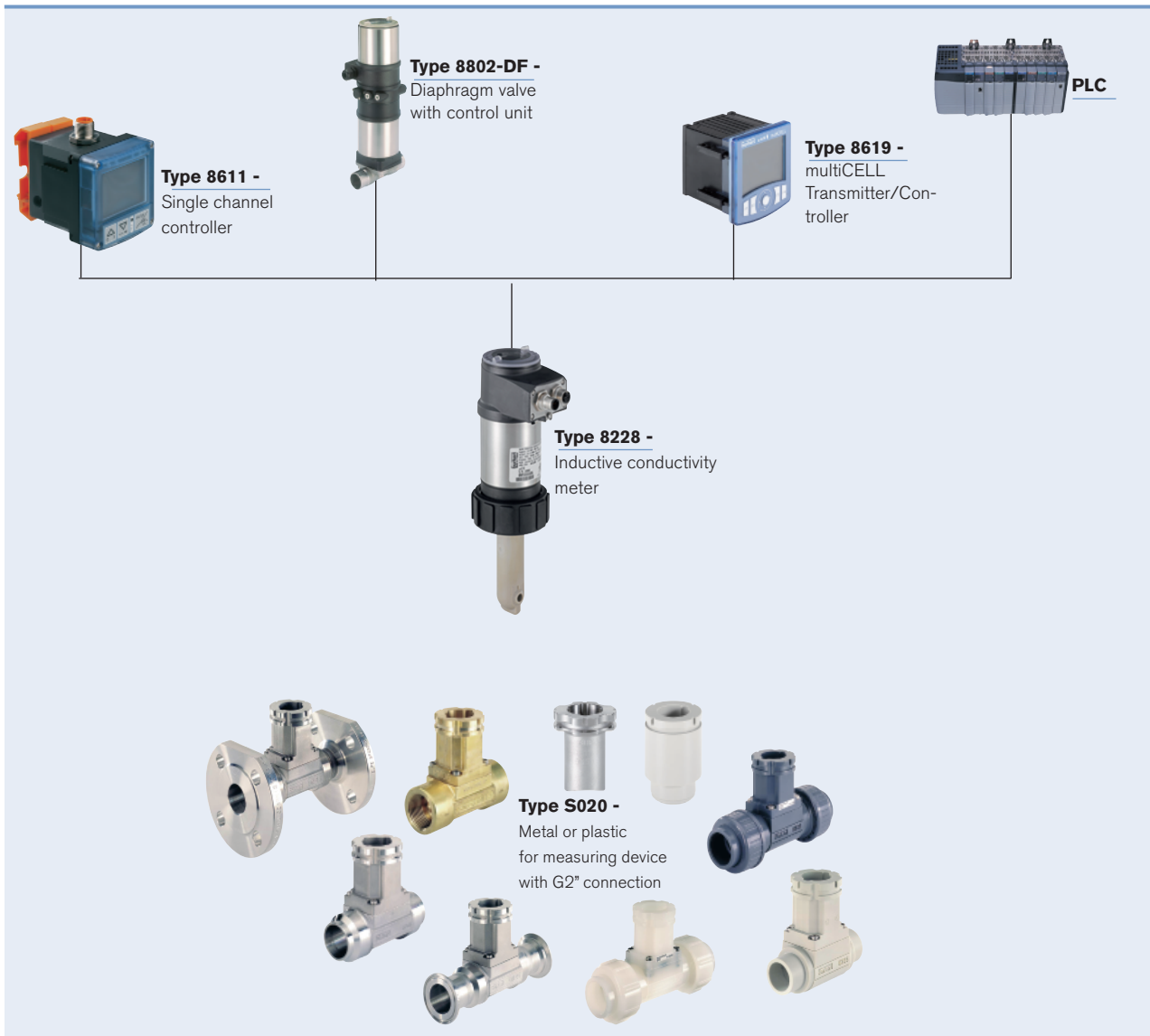

DTS 1000220089 EN Version: B Status: RL (released | freigegeben | valide) printed: 19.01.2015

To find your nearest Bürkert office, click on the orange box →

www.burkert.com

In case of special application conditions, please consult for advice.

Subject to alteration.
© Christian Bürkert GmbH & Co. KG

1412/2_EU-en_00895254