

Type 8692, 8693

Electropneumatic positioner and process controller



Operating Instructions

Bedienungsanleitung
Manuel d'utilisation

We reserve the right to make technical changes without notice.
Technische Änderungen vorbehalten.
Sous réserve de modifications techniques.

© 2008-2014 Bürkert Werke GmbH

Operating Instructions 1411/03_EU-en_00806169 / Original DE

TABLE OF CONTENTS

GENERAL INFORMATION AND SAFETY INSTRUCTIONS	5
1 Operating instructions.....	6
2 Authorized use	7
3 Basic safety instructions.....	8
4 General information.....	9
DESCRIPTION OF SYSTEM	11
5 DESCRIPTION AND FEATURES OF TYPE 8692/8693.....	13
6 Structure.....	17
7 Positioner Type 8692	19
8 Process controller Type 8693.....	23
9 Interfaces of the positioner / process controller	27
10 Technical data.....	28
11 Accessories.....	32
INSTALLATION	33
12 Installation	35
13 Electrical Installation 24 V DC.....	49
14 Disassembly of Type 8692/8693.....	61
OPERATION	63
15 Operating levels.....	64
16 Operating and display elements.....	65
17 Operating states.....	73
18 Activating and deactivating auxiliary functions.....	74
19 Manually opening and closing the valve	76
START-UP	77
20 Start-up sequence.....	78
21 Safety instructions	79
22 Basic setting of the device	79

23	Activation of the process controller.....	86
24	Basic setting of the process controller.....	87
AUXILIARY FUNCTIONS.....		107
25	Configuring the auxiliary functions	108
OPERATING STRUCTURE / FACTORY SETTINGS.....		177
26.	Operating structure and factory settings.....	178
PROFIBUS DP		193
27	Description of the PROFIBUS DP	194
28	Electrical connections	196
29	Start-up PROFIBUS DP	199
DEVICENET		207
30	Description	208
31	Electrical connections	212
32	Start-up DeviceNet.....	216
MAINTENANCE AND TROUBLESHOOTING.....		227
33	Maintenance	228
34	Error messages and malfunctions	228
PACKAGING, STORAGE, DISPOSAL.....		233
35	Packaging and transport.....	234
36	Storage	234
37	Disposal	234
ADDITIONAL TECHNICAL INFORMATION.....		235
38	Selection criteria for continuous valves	236
39	Properties of PID Controllers	238
40	Adjustment rules for PID Controllers.....	243
TABLES FOR CUSTOMER-SPECIFIC SETTINGS		247
41.	Table for your settings on the positioner.....	248
42.	Table for your settings on the process controller Type 8693	249

General information and safety instructions

CONTENTS

1	OPERATING INSTRUCTIONS.....	6
1.1	Symbols	6
1.2	Definition of the term “device”	6
2	AUTHORIZED USE	7
2.1	Restrictions	7
3	BASIC SAFETY INSTRUCTIONS.....	8
4	GENERAL INFORMATION.....	9
4.1	Scope of supply.....	9
4.2	Contact address	9
4.3	Warranty	9
4.4	Master code	9
4.5	Information on the internet.....	9

MAN 1000108626 EN Version: F Status: RL (released | freigegeben) printed: 20.01.2015

1 OPERATING INSTRUCTIONS

The operating instructions describe the entire life cycle of the device. Keep these instructions in a location which is easily accessible to every user and make these instructions available to every new owner of the device.

WARNING!

The operating instructions contain important safety information!

Failure to observe these instructions may result in hazardous situations.

- ▶ The operating instructions must be read and understood.

1.1 Symbols

DANGER!

Warns of an immediate danger!

- ▶ Failure to observe the warning may result in a fatal or serious injury.

WARNING!

Warns of a potentially dangerous situation!

- ▶ Failure to observe the warning may result in serious injuries or death.

CAUTION!


Warns of a possible danger!


- ▶ Failure to observe this warning may result in a medium or minor injury.

NOTE!

Warns of damage to property!

- Failure to observe the warning may result in damage to the device or the equipment.

 indicates important additional information, tips and recommendations.

 refers to information in these operating instructions or in other documentation.

→ designates a procedure that must be carried out.

1.2 Definition of the term “device”

In these instructions, the term “device” always refers to the Type 8692/8693

2 AUTHORIZED USE

Incorrect use of the Type 8692 and 8693 can be dangerous to people, nearby equipment and the environment.

The device is designed to be mounted on pneumatic actuators of process valves for the control of media.

- ▶ In a potentially explosive area, Type 8692 and 8693 may be used only in accordance with the specification on the separate Ex rating plate. For the use, observe the ATEX manual with safety instructions for the Ex area.
- ▶ Devices without a separate Ex rating plate may not be used in a potentially explosive area.
- ▶ The device must not be exposed to direct sunlight.
- ▶ Pulsating direct voltage (rectified alternating voltage without smoothing) must not be used as operating voltage.
- ▶ During use observe the permitted data, the operating conditions and conditions of use specified in the contract documents and operating instructions, as described in chapter [“10 Technical data”](#) in this manual and in the valve manual for the respective pneumatically actuated valve.
- ▶ The device may be used only in conjunction with third-party devices and components recommended and authorised by Bürkert.
- ▶ In view of the wide range of possible application cases, check whether the device is suitable for the specific application case and check this out if required.
- ▶ Correct transportation, correct storage and installation and careful use and maintenance are essential for reliable and faultless operation.
- ▶ Use the Type 8692 and 8693 only as intended.

2.1 Restrictions

If exporting the system/device, observe any existing restrictions.

3 BASIC SAFETY INSTRUCTIONS

These safety instructions do not make allowance for any

- contingencies and events which may arise during the installation, operation and maintenance of the devices.
- local safety regulations – the operator is responsible for observing these regulations, also with reference to the installation personnel.



Risk of injury from high pressure in the system/device.

- ▶ Before working on the system or device, switch off the pressure and vent/drain lines.

Risk of injury due to electrical shock.

- ▶ Before reaching into the device or the equipment, switch off the power supply and secure to prevent reactivation!
- ▶ Observe applicable accident prevention and safety regulations for electrical equipment.

General hazardous situations.

To prevent injuries:

- ▶ The device must only be operated when in a perfect condition and in consideration of the operating instructions.
- ▶ Secure the system/device from unintentional actuation.
- ▶ Only trained technicians may perform installation and maintenance work.
- ▶ After an interruption in the power supply, ensure that the process is restarted in a controlled manner.
- ▶ Observe the general rules of technology.

To prevent damage to the device:

- ▶ When unscrewing and screwing the housing jacket (with transparent cap) in, do not hold the actuator but the electrical connection housing of Type 8692/8693.
- ▶ Do not supply the pilot air port with aggressive or flammable media or fluids.
- ▶ Do not make any internal or external changes on the device and do not subject it to mechanical stress.

NOTE!

Electrostatic sensitive components / modules!

The device contains electronic components which react sensitively to electrostatic discharge (ESD). Contact with electrostatically charged persons or objects is hazardous to these components. In the worst case scenario, they will be destroyed immediately or will fail after start-up.

- Observe the requirements in accordance with EN 61340-5-1 to minimise or avoid the possibility of damage caused by sudden electrostatic discharge!
- Also ensure that you do not touch electronic components when the operating voltage is present!

4 GENERAL INFORMATION

4.1 Scope of supply

In general it consists of:

- Type 8692/8693 and associated operating instructions.
 - Brief instructions (Quickstart) in printed form as well as
 - Main instructions on CD.



For the circular plug-in connector version (multi-pole version) of Type 8692/8693, we will provide you with suitable cable connectors as accessories.

If there are any discrepancies, please contact us immediately.

4.2 Contact address

Germany

Bürkert Fluid Control Systems
Sales Center
Chr.-Bürkert-Str. 13-17
D-74653 Ingelfingen
Tel. + 49 (0) 7940 - 10 91 111
Fax + 49 (0) 7940 - 10 91 448
E-mail: info@de.buerkert.com

International

Contact addresses can be found on the final pages of the printed brief instructions (Quickstart).

And also on the internet at: www.burkert.com

4.3 Warranty

The warranty is only valid if the Type 8692/8693 are used as intended in accordance with the specified application conditions.

4.4 Master code

Operation of the device can be locked via a freely selectable user code. In addition, there is a non-changeable master code with which you can perform all operator actions on the device. This 4-digit master code can be found on the last pages of the printed brief instructions which are enclosed with each device.

If required, cut out the code and keep it separate from these operating instructions.

4.5 Information on the internet

The operating instructions and data sheets for Type 8692 and 8693 can be found on the Internet at:

www.burkert.com

Description of System

CONTENTS

5	DESCRIPTION AND FEATURES OF TYPE 8692/8693	13
5.1	General description	13
5.2	Features	13
5.3	Combinations with valve types and mounting versions	14
5.3.1	Overview of mounting possibilities / features of valve types.....	15
5.4	Designs	16
5.4.1	Type 8692, positioner	16
5.4.2	Type 8693, process controller	16
6	STRUCTURE.....	17
6.1	Representation.....	17
6.2	Function diagram	18
6.2.1	Diagram illustrating single-acting actuator	18
7	POSITIONER TYPE 8692.....	19
7.1	Schematic representation of the position control	20
7.2	Positioner software.....	21
8	PROCESS CONTROLLER TYPE 8693.....	23
8.1	Schematic representation of process control.....	24
8.2	The process controller software.....	25
9	INTERFACES OF THE POSITIONER / PROCESS CONTROLLER.....	27
10	TECHNICAL DATA.....	28
10.1	Conformity	28
10.2	Standards.....	28
10.3	Licenses.....	28
10.4	Operating conditions	28
10.5	Rating plate	29
10.5.1	UL additional label	29
10.6	Mechanical data.....	29

10.7	Pneumatic data	29
10.8	Electrical data	30
10.9	Safety end positions after failure of the electrical or pneumatic auxiliary power	31
10.10	Factory settings	32
11.1	Communications software	32
11.2	USB interface	32

5 DESCRIPTION AND FEATURES OF TYPE 8692/8693

5.1 General description

Positioner Type 8692 / process controller Type 8693 is an electropneumatic position controller for pneumatically actuated control valves with single-acting or double-acting actuators. The device incorporates the main function groups

- Position sensor
- Electro-pneumatic control system
- Microprocessor electronics

The position sensor measures the current positions of the continuous valve.

The microprocessor electronics continuously compare the current position (actual value) with a position set-point value specified via the standard signal input and supplies the result to the positioner.

If there is a control difference, the electro-pneumatic control system corrects the actual position accordingly.

5.2 Features

▪ Models

- Positioner (position controller) Type 8692
 - Process controller with integrated position controller, Type 8693
- Types 8692 and 8693 are available for both single-acting and double-acting actuators.

▪ Position sensor

A non-contact and therefore wear parts position sensor.

▪ Microprocessor-controlled electronics

For signal processing, control and valve control.

▪ Control module

Operation of the device is controlled by four keys. The 128 x 64 dot matrix graphics display enables you to display the set-point value or actual value and to configure and parameterize via menu functions.

▪ Control system

For low air flow rate:

The direct-acting model has an orifice of DN 0.6.

The control system for single-acting actuators consists of 2 solenoid valves and of 4 solenoid valves for double-acting actuators. In single-acting actuators, one valve serves for the aeration and another for the deaeration of the pneumatic actuator. Double-acting actuators feature 2 valves for aeration and deaeration.

For high air flow rate:

Orifice DN 2.5 is also available for pneumatic actuators (single-acting only).

The solenoid valves are equipped with diaphragm amplifiers to increase the maximum flow and therefore to improve the dynamics.

▪ Position feedback (optional)

Position feedback is implemented either via a proximity switch (initiator), via binary outputs or via an output (4 ... 20 mA / 0 ... 10 V).

When the valve reaches an upper or lower position, this position can be relayed e.g. to a PLC via binary outputs. The initiator is used to set the upper and lower end position of the valve. It can be changed with a setting screw.

▪ Pneumatic interfaces

1/4" connections with different thread forms (G, NPT) of hose plug-in connection.

▪ **Electrical interfaces**

Circular plug-in connector or cable gland.

▪ **Housing**

The housing of Type 8692/8693 is protected from excessively high internal pressure, e.g. due to leaks, by a pressure limiting valve.

5.3 Combinations with valve types and mounting versions

The positioner Type 8692 / process controller Type 8693 can be mounted on different process valves from the Bürkert range.

Angle seat valves, straight seat valves, control valves, diaphragm or ball valves are suitable (see chapter [“5.3.1 Overview of mounting possibilities / features of valve types”](#)).

- For single-acting actuators, only one chamber is aerated and deaerated during actuation. The generated pressure works against a spring. The piston moves until there is an equilibrium of forces between compressive force and spring force.
- For double-acting actuators the chambers on both sides of the piston are pressurized. In this case, one chamber is aerated when the other one is deaerated and vice versa.

There are two different procedures for valve installation.

In [“Figure 1”](#) shows two combination possibilities that serve as examples of valve installation in general. The two procedures are explained in chapter [“12 Installation”](#) based on these examples.

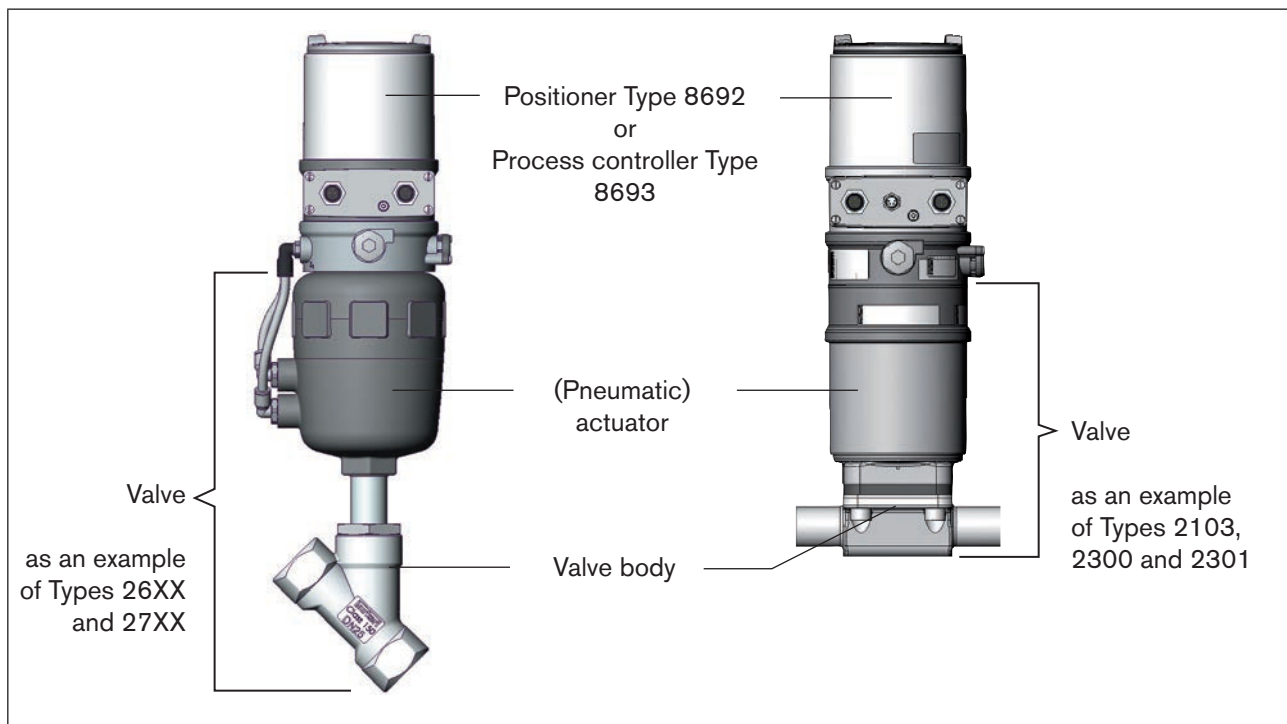


Figure 1: Mounting versions. Valve types with different installation

5.3.1 Overview of mounting possibilities / features of valve types

	Slanted seat control valves / screw-down stop globe control valves	Diaphragm valves	Ball valves	Flap valves
Types	<ul style="list-style-type: none"> ▪ 2702 ▪ 2712 ▪ 2300 ▪ 2301 	<ul style="list-style-type: none"> ▪ 2730 ▪ 2103 ▪ 2731 	<ul style="list-style-type: none"> ▪ 2652 ▪ 2655 ▪ 2658 	<ul style="list-style-type: none"> ▪ 2672 ▪ 2675
Features	<ul style="list-style-type: none"> ▪ incoming flow under seat ▪ closes smoothly ▪ straight flow path of the medium ▪ self-adjusting stuffing box for high leak-tightness 	<ul style="list-style-type: none"> ▪ medium is hermetically separated from the actuator and environment ▪ cavity-free and self-draining body design ▪ any flow direction with low-turbulence flow ▪ steam-sterilizable ▪ CIP-compliant ▪ closes smoothly ▪ actuator and diaphragm can be removed when the body is installed 	<ul style="list-style-type: none"> ▪ scrapable ▪ minimum dead space ▪ unaffected by contamination ▪ little pressure loss compared to other valve types ▪ seat and seal can be exchanged in the three-piece ball valve when installed <p>Information Can be used as process controller only</p>	<ul style="list-style-type: none"> ▪ unaffected by contamination ▪ little pressure loss compared to other valve types ▪ inexpensive ▪ low construction volume
Typical media	<ul style="list-style-type: none"> ▪ water, steam and gases ▪ alcohols, oils, propellants, hydraulic fluids ▪ salt solutions, lyes (organic) ▪ solvents 	<ul style="list-style-type: none"> ▪ neutral gases and liquids ▪ contaminated, abrasive and aggressive media ▪ media of higher viscosity 	<ul style="list-style-type: none"> ▪ neutral gases and liquids ▪ clean water ▪ slightly aggressive media 	<ul style="list-style-type: none"> ▪ neutral gases and liquids ▪ slightly aggressive media

Table 1: Overview of mounting possibilities / features of valve types



Different actuator sizes and valve orifices are available for each valve type. More precise specifications can be found on the respective data sheets. The product range is being continuously expanded.

5.4 Designs

5.4.1 Type 8692, positioner

The position of the actuator is regulated according to the position set-point value. The position set-point value is specified by an external standard signal (or via field bus).

5.4.2 Type 8693, process controller

Type 8693 also features a PID controller which, apart from actual position control, can also be used to implement process control (e.g. level, pressure, flow rate, temperature) in the sense of a cascade control.

The process controller Type 8693 is operated with a 128 x 64 dot matrix graphics display and a keypad with 4 keys.

The process controller is linked to a control circuit. The position set-point value of the valve is calculated from the process set-point value and the actual process value via the control parameters (PID controller). The process set-point value can be set by an external signal.

6 STRUCTURE

The positioner Type 8692 and process controller Type 8693 consist of the micro-processor controlled electronics, the position sensor and the control system.

The device is designed using three-wire technology. Operation is controlled by four keys and a 128x64 dot matrix graphics display.

The pneumatic control system for single-acting and double-acting actuators consists of 2 solenoid valves or 4 solenoid valves.

6.1 Representation

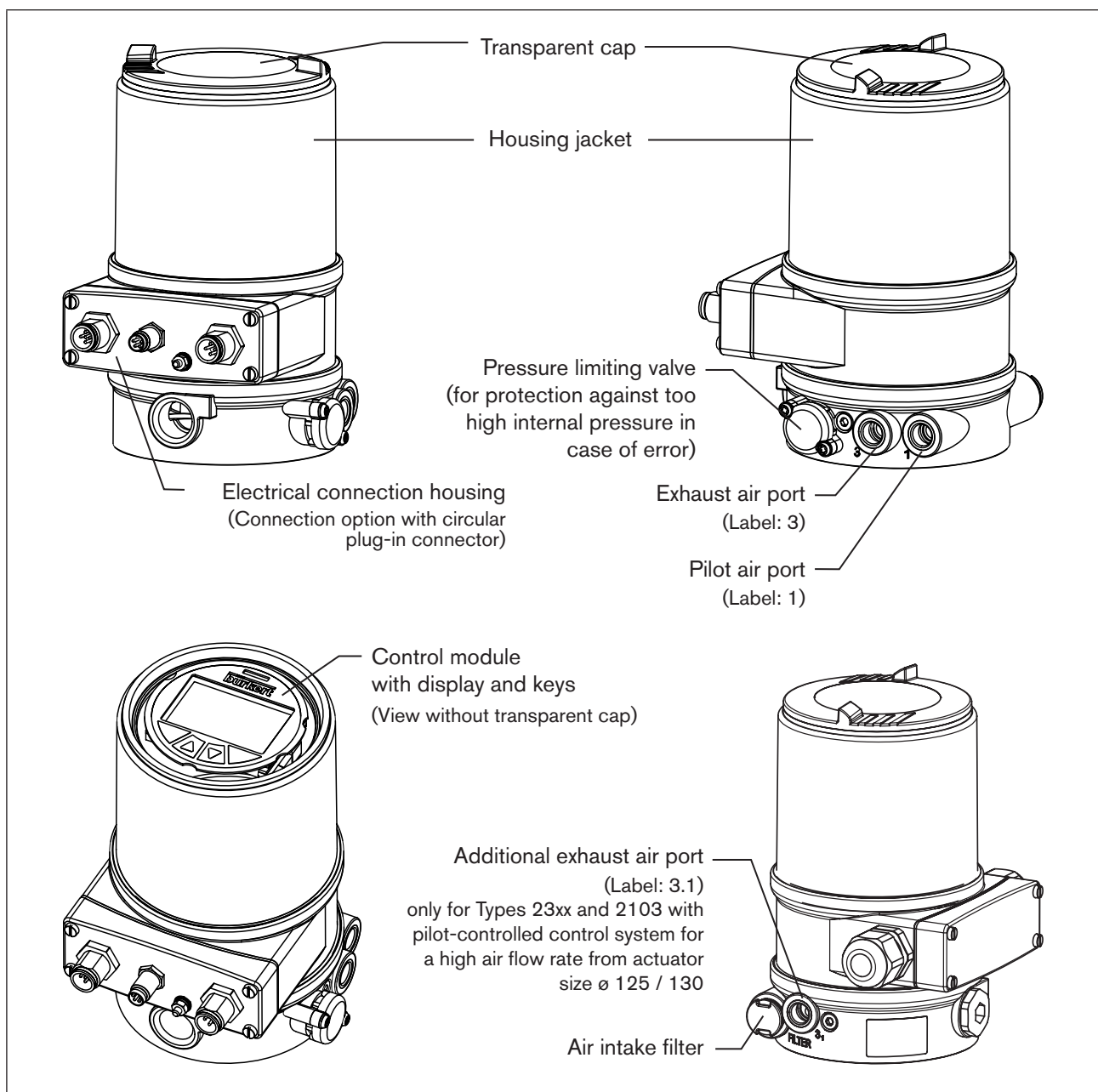


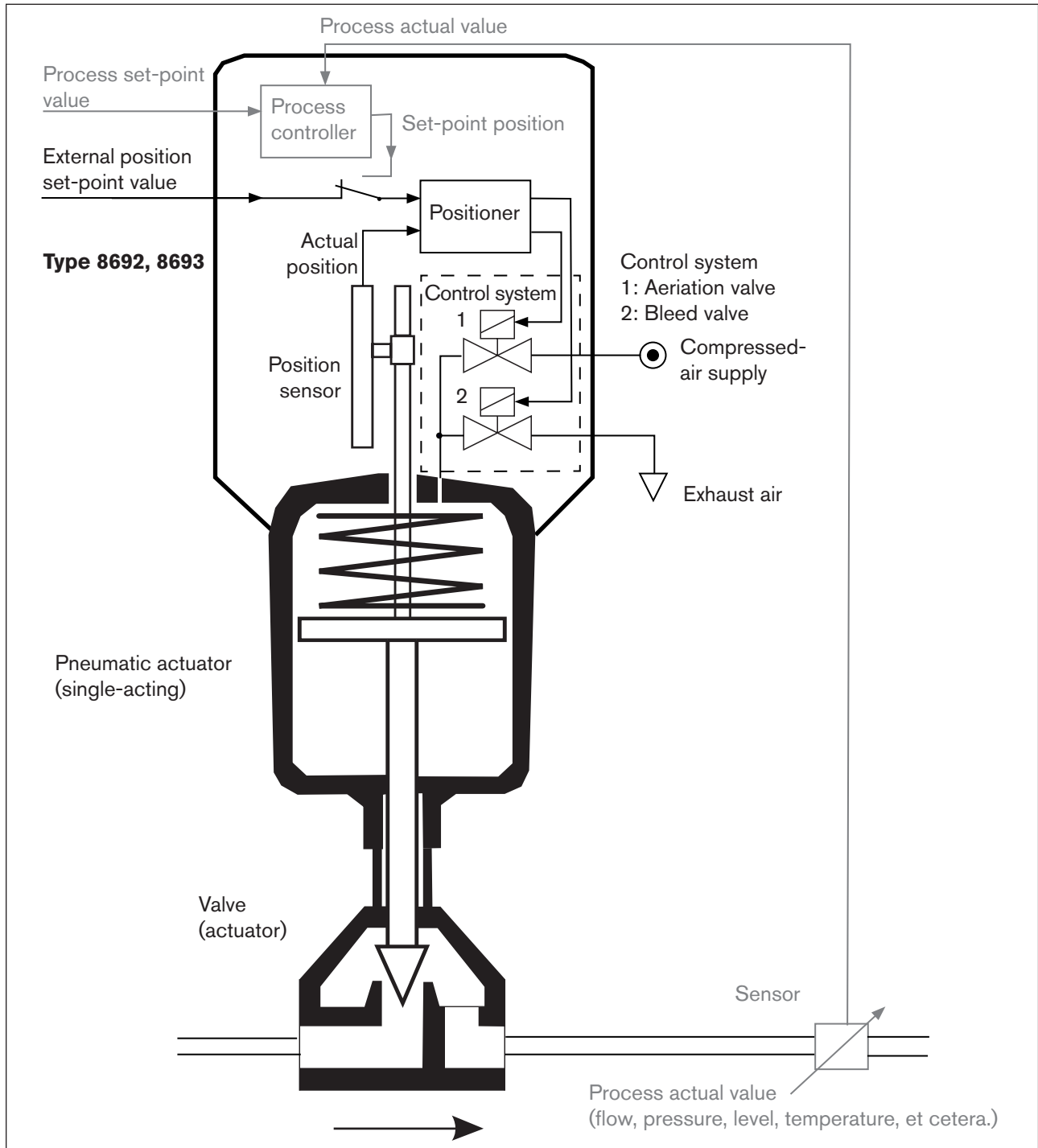
Figure 2: Structure, Type 8692 / 8693

6.2 Function diagram

6.2.1 Diagram illustrating single-acting actuator

The black lines in "Figure 3" specify the function of the position controller circuit in Type 8692.

The grey part of the diagram indicates the additional function of the superimposed process control circuit in Type 8693.



MAN 1000108626 EN Version: F Status: RL (released | freigegeben) printed: 20.01.2015

7 POSITIONER TYPE 8692

The position sensor records the current position (*POS*) of the pneumatic actuator. The positioner compares this actual position value with the set-point value (*CMD*) which is specified as a standard signal. In case of a control deviation (*Xd1*), a pulse-width modulated voltage signal is sent to the control system as a manipulated variable. If there is a positive control difference in single-acting actuators, the air inlet valve is controlled via output *B1*. If the control difference is negative, the bleed valve is controlled via output *E1*. In this way the position of the actuator is changed until control difference is 0. *Z1* represents a disturbance variable.

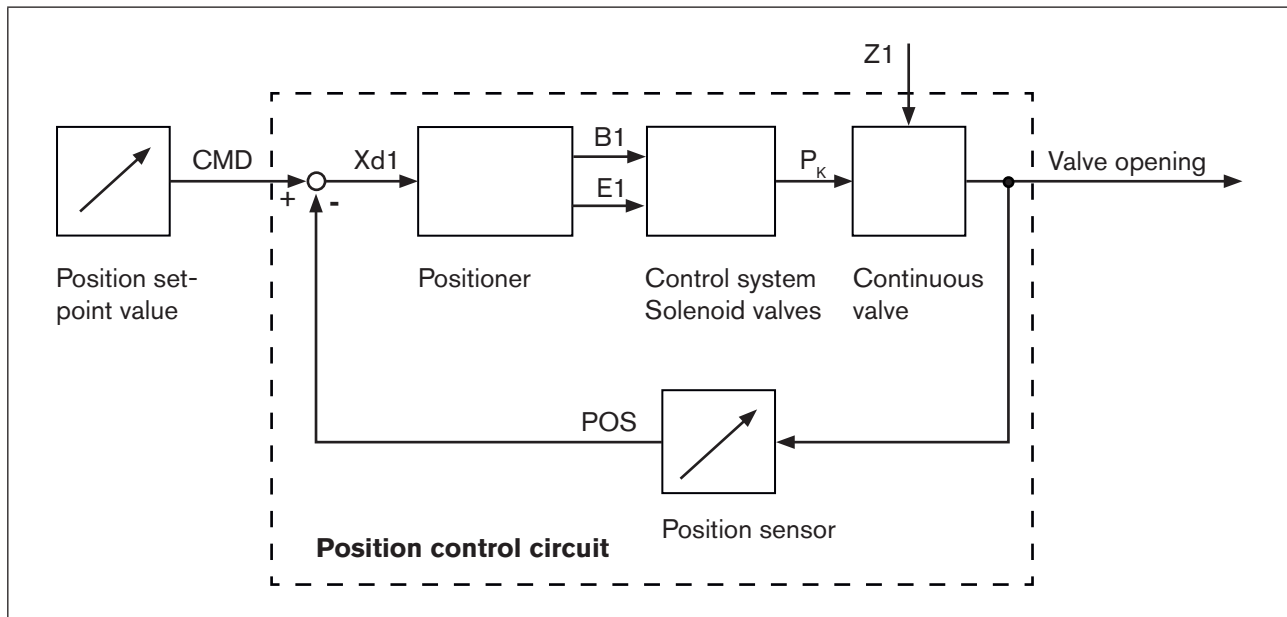


Figure 4: Position control circuit in Type 8692

7.1 Schematic representation of the position control

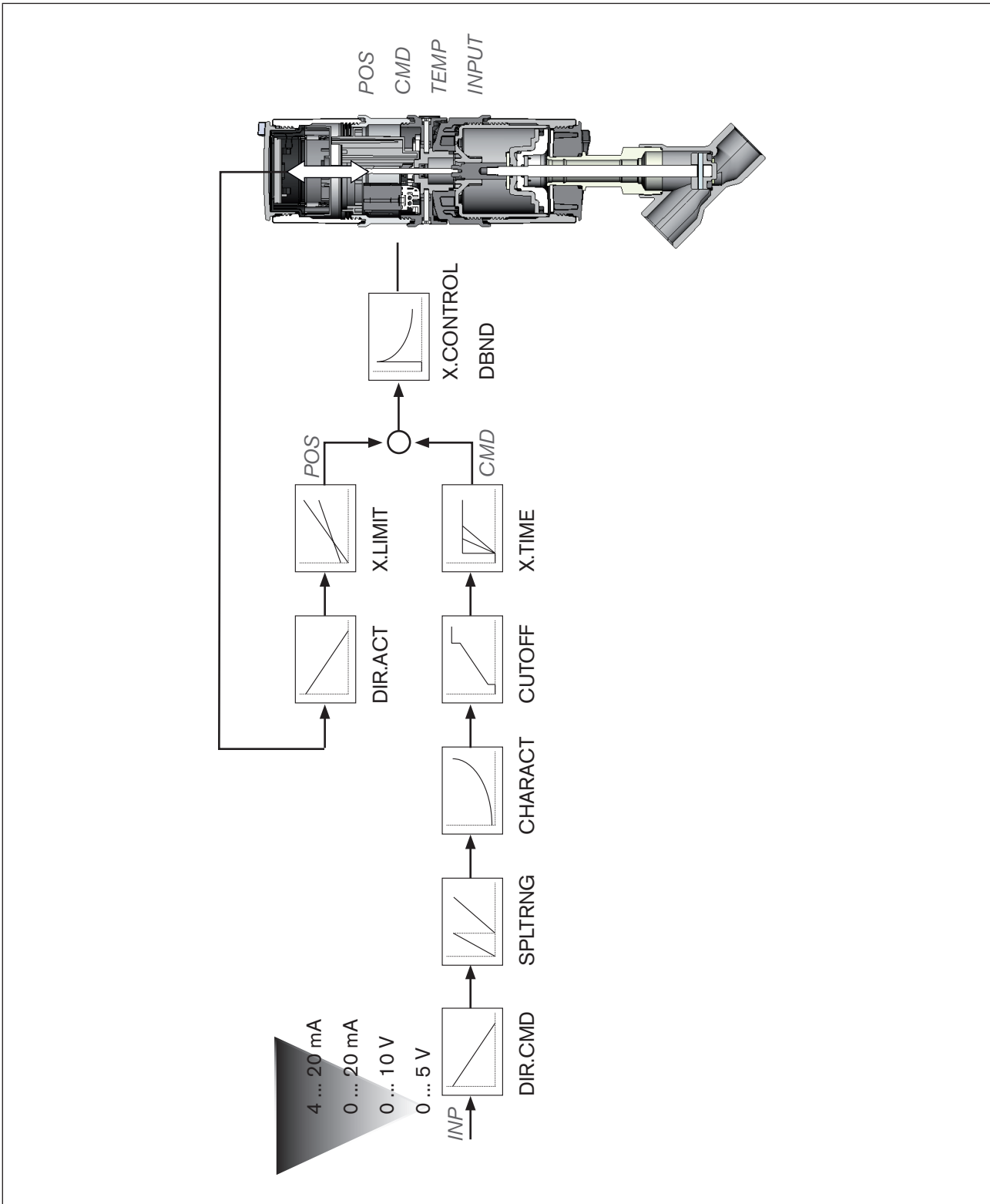


Figure 5: Schematic representation of position control

7.2 Positioner software

Configurable auxiliary functions	Effect
Correction line to adjust the operating characteristic <i>CHARACT</i>	Selection of the transfer characteristic between input signal and stroke (correction characteristic)
Sealing function <i>CUTOFF</i>	Valve closes tight outside the control range. Specification of the value (in %), from which the actuator is completely deaerated (when 0%) or aerated (when 100%).
Sense of effective direction of the controller set-point value <i>DIR.CMD</i>	Reversal of the sense of effective direction of the set-point value
Sense of effective direction of the actuator <i>DIR.ACT</i>	Adjustment of the sense of effective direction between aeration state of the actuator and the actual position
Signal split range <i>SPLTRNG</i>	Splitting of the standard signal range to two or more positioners
Stroke limit <i>X.LIMIT</i>	Mechanical valve piston movement only within a defined stroke range
Limiting the control speed <i>X.TIME</i>	Input of the opening and closing time for the entire stroke
Insensitivity range <i>X.CONTROL</i>	The positioner is initially actuated from a control difference to be defined
Code protection <i>SECURITY</i>	Code protection for settings
Safety position <i>SAFEPOS</i>	Definition of the safety position
Signal level error detection <i>SIG.ERROR</i>	Check the input signals for sensor break. Warning output on the display and start up of the safety position (if selected)
Binary input <i>BINARY. IN</i>	Switch over AUTOMATIC / MANUAL or Start up of the safety position
Analogue feedback (option) <i>OUTPUT</i>	Status signal set-point value or actual value
2 binary outputs (option) <i>OUTPUT</i>	Output of two selectable binary values
User calibration <i>CAL.USER</i>	Change to the factory calibration of the signal input
Factory settings <i>SET.FACTORY</i>	Reset to factory settings
Serial interface <i>SER.I/O</i>	Configuration of serial interface

Configurable auxiliary functions	Effect
Setting display <i>EXTRAS</i>	Adjustment of the display of the process level
<i>SERVICE</i>	For internal use only
Simulation software <i>SIMULATION</i>	For simulation of the device functions
<i>DIAGNOSE (Option)</i>	Monitoring of processes

Table 2: Positioner software. Configurable auxiliary functions

Hierarchical operating concept for easy operation on the following operating levels	
Process level	On the process level switch between AUTOMATIC mode and MANUAL mode.
Setting level	On the setting level specify certain basic functions during start-up and, if required, configure additional functions

Table 3: The positioner software. Hierarchical operating concept.

8 PROCESS CONTROLLER TYPE 8693

In the case of process controller Type 8693 the position control mentioned in chapter “7” becomes the subordinate auxiliary control circuit; this results in a cascade control. The process controller in the main control circuit of Type 8693 has a PID function.

The process set-point value (SP) is specified as set-point value and compared with the actual value (PV) of the process variable to be controlled.

The position sensor records the current position (POS) of the pneumatic actuator. The positioner compares this actual position value with the set-point value (CMD), which is determined by the process controller.

In case of a control difference (X_{d1}), a pulse-width modulated voltage signal is sent to the control system as an actuating variable.

If there is a positive control difference in single-acting actuators, the aeration valve is controlled via output B1. If the control difference is negative, the bleed valve is controlled via output E1. In this way the position of the actuator is changed until control difference is 0. Z_2 represents a disturbance variable.

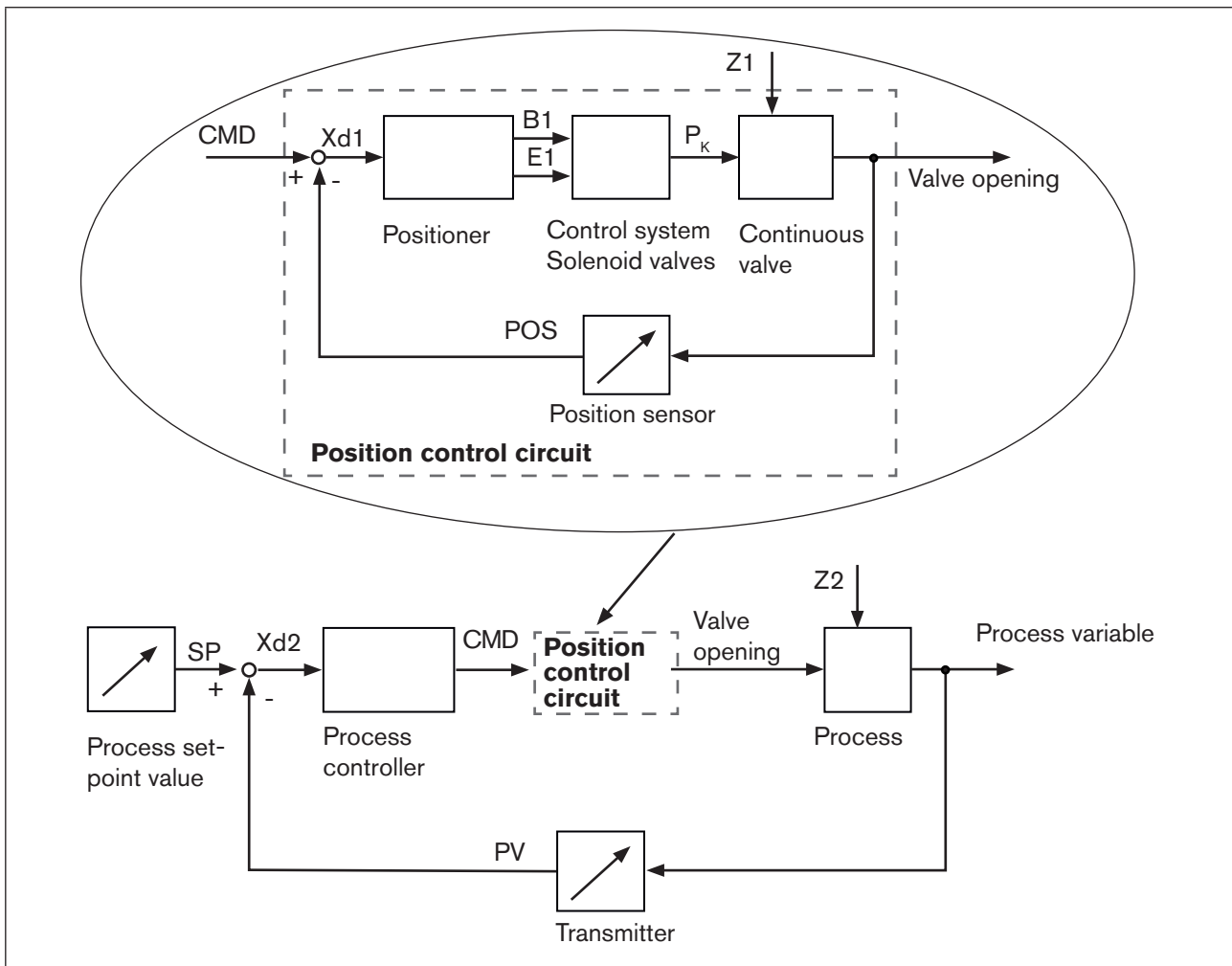


Figure 6: Signal flow plan of process controller

8.1 Schematic representation of process control

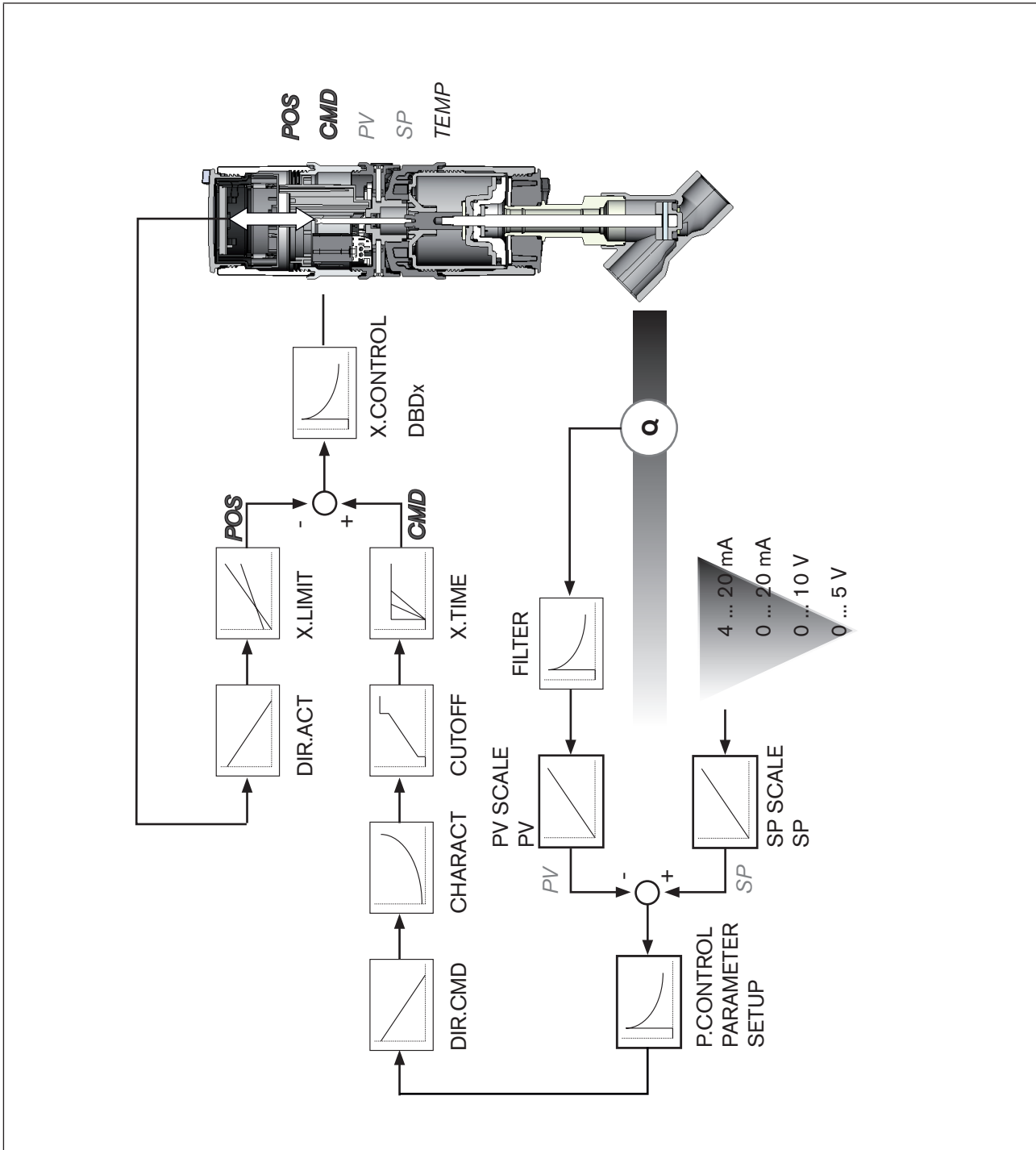


Figure 7: Schematic representation of process control

8.2 The process controller software

Configurable auxiliary functions	Effect
Correction line to adjust the operating characteristic <i>CHARACT</i>	Selection of the transfer characteristic between input signal and stroke (correction characteristic)
Sealing function <i>CUTOFF</i>	Valve closes tight outside the control range. Specification of the value (in %), from which the actuator is completely deaerated (when 0%) or aerated (when 100%).
Sense of effective direction of the controller set-point value <i>DIR.CMD</i>	Reversal of the sense of effective direction of the set-point value
Sense of effective direction of the actuator <i>DIR.ACT</i>	Adjustment of the sense of effective direction between aeration state of the actuator and the actual position
Signal split range <i>SPLTRNG</i>	Splitting of the standard signal range to two or more positioners
Stroke limit <i>X.LIMIT</i>	Mechanical valve piston movement only within a defined stroke range
Limiting the control speed <i>X.TIME</i>	Input of the opening and closing time for the entire stroke
Insensitivity range <i>X.CONTROL</i>	The positioner is initially actuated from a control difference to be defined
Code protection <i>SECURITY</i>	Code protection for settings
Safety position <i>SAFEPOS</i>	Definition of the safety position
Signal level error detection <i>SIG.ERROR</i>	Check the input signals for sensor break. Warning output on the display and start up of the safety position (if selected)
Binary input <i>BINARY.IN</i>	Switch over AUTOMATIC / MANUAL or Start up of the safety position
Analogue feedback (option) <i>OUTPUT</i>	Status signal set-point or actual value
2 binary outputs (option) <i>OUTPUT</i>	Output of two selectable binary values
User calibration <i>CAL.USER</i>	Change to the factory calibration of the signal input
Factory settings <i>SET.FACTORY</i>	Reset to factory settings
Serial interface <i>SER.I/O</i>	Configuration of serial interface

Configurable auxiliary functions	Effect
Setting display <i>EXTRAS</i>	Adjustment of the display of the process level
<i>SERVICE</i>	For internal use only
Simulation software <i>SIMULATION</i>	For simulation of the device functions
<i>DIAGNOSE (Option)</i>	Monitoring of processes

Table 4: The process controller software. Configurable auxiliary functions

Functions and setting options of the process controller	
Process controller <i>P.CONTROL</i>	PID - Process controller is activated
Adjustable parameters <i>P.CONTROL - PARAMETER</i>	Parameterization of the process controller Proportional coefficient, reset time, hold-back time and operating point
Scalable inputs <i>P.CONTROL - SETUP</i>	Configuration of the process controller - Selection of the sensor input - Scaling of process actual value and process set-point value Selection of the set-point value defaults
Automatic sensor detection or manual sensor setting <i>P.CONTROL - SETUP - PV INPUT</i>	Sensor types Pt100 and 4 – 20 mA are automatically detected or can be set manually via the operating menu
Selection of the set-point value specification <i>P.CONTROL - SETUP - SP INPUT</i>	Set-point value specification either via standard signal input or via keys
Process characteristic linearization <i>P.Q'LIN</i>	Function for automatic linearization of the process characteristics
Process controller optimization <i>P.TUNE</i>	Function for automatic optimization of the process controller parameters

Table 5: The process controller software. Functions and setting options of the process controller

Hierarchical operating concept for easy operation on the following operating levels	
Process level	On the process level switch between AUTOMATIC and MANUAL mode.
Setting level	On the setting level specify certain basic functions during start-up and configure auxiliary functions if required.

Table 6: The process controller software. Hierarchical operating concept

MAN 1000108626 EN Version: F Status: RL (released | freigegeben) printed: 20.01.2015

9 INTERFACES OF THE POSITIONER / PROCESS CONTROLLER

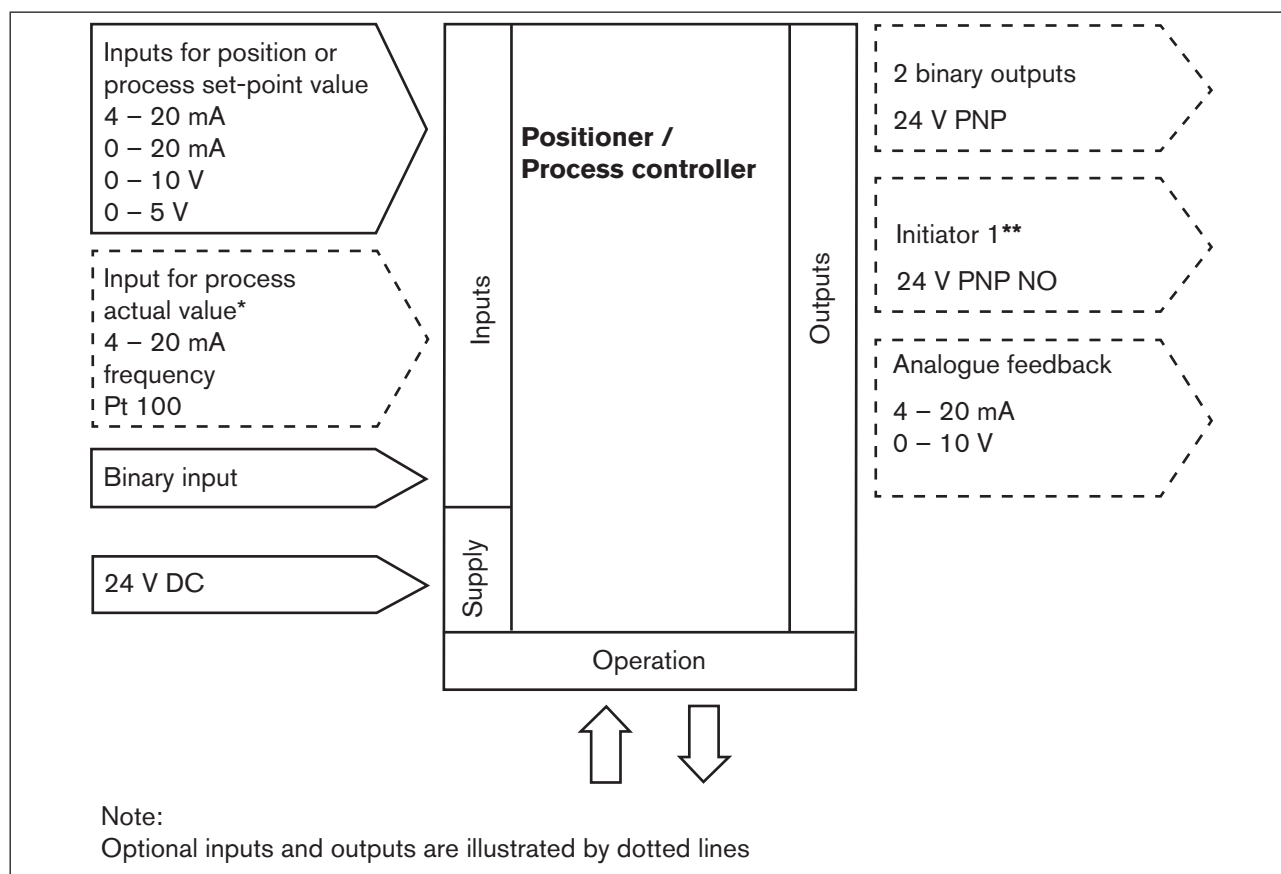


Figure 8: Interfaces of the positioner / process controller



The Types 8692 and 8693 are 3-wire devices, i.e. the power (24 V DC) is supplied separately from the set-point value signal.

* only for process controller Type 8693

** Only present with electrical connection via circular plug-in connector (multi-pole version)

10 TECHNICAL DATA

10.1 Conformity

In accordance with the Declaration of conformity, Type 8692 / 8693 is compliant with the EC Directives.

10.2 Standards

The applied standards which are used to demonstrate compliance with the EC Directives are listed in the EC-Type Examination Certificate and/or the EC Declaration of Conformity.

10.3 Licenses

The product is approved for use in zone 2 and 22 in accordance with ATEX directive 94/9/EC category 3GD.



Observe instructions on operation in an explosion-risk (Ex) area.

Observe the ATEX additional instructions.

The product is cULus approved. Instructions for use in the UL area see chapter [“10.8 Electrical data”](#).

10.4 Operating conditions



WARNING!

Solar radiation and temperature fluctuations may cause malfunctions or leaks.

- ▶ If the device is used outdoors, do not expose it unprotected to the weather conditions.
- ▶ The permitted ambient temperature may not exceed the maximum value or drop below the minimum value.

Ambient temperature The permitted temperature range is given on the rating plate of the device.

Degree of protection

Evaluated by the manufacturer:	Evaluated by UL:
IP65 / IP67 according to EN 60529 *	UL Type 4x Rating *
* only if cables, plugs and sockets have been connected correctly and in compliance with the exhaust air concept (see chapter “12.7 Pneumatic connection of the Type 8692/8693” , page 46.	

10.5 Rating plate

Explanation of the device-specific specifications on the rating plate:

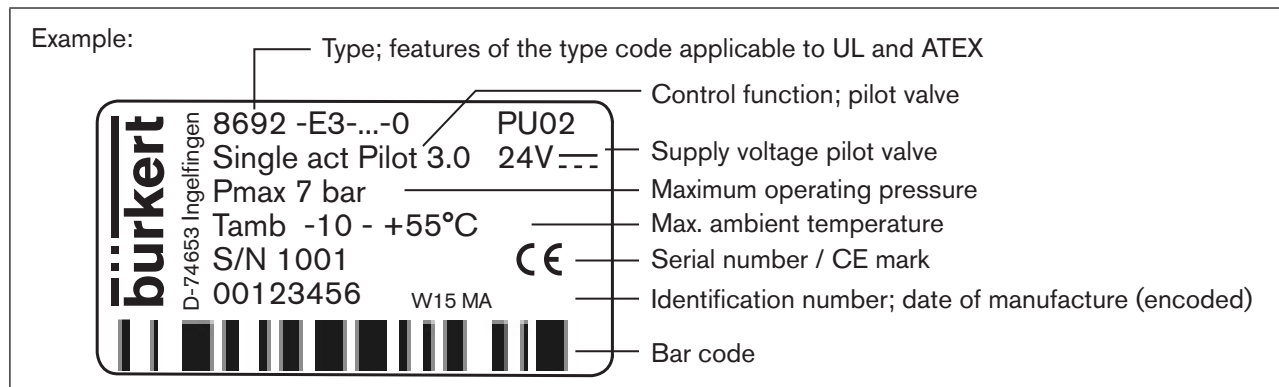


Figure 9: Example of rating plate

10.5.1 UL additional label

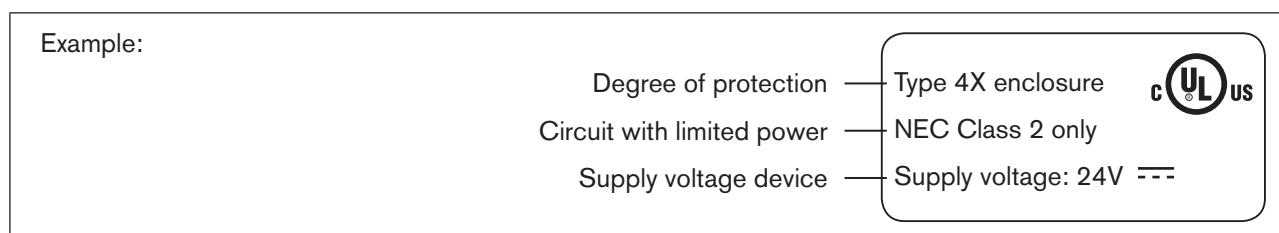


Figure 10: UL additional label (example)

10.6 Mechanical data

Dimensions	see data sheet
Housing material	outside: PPS, PC, VA, interior: PA 6; ABS
Sealing material	NBR / EPDM
Stroke range valve spindle	3 ... 45 mm

10.7 Pneumatic data

Control medium	Neutral gases, air Quality classes as per ISO 8573-1
Dust content	Quality class 7, max. particle size 40 µm, max. particle density 10 mg/m ³
Water content	Quality class 3, max. pressure dew point - 20 °C or min. 10°C below the lowest operating temperature
Oil content	Quality class X, max. 25 mg/m ³

Temperature range control medium	0 ... + 50 °C
Pressure range control medium	3 ... 7 bar
Air flow rate pilot valve	7 I _N / min (for aeration and deaeration) (Q _{Nn} - value according to definition for pressure drop from 7 to 6 bar absolute) optional: 130 I _N / min (for aeration and deaeration) (only single-acting connections)
Connections	Plug-in hose connector ø 6 mm / 1/4" socket connection G1/8

10.8 Electrical data



WARNING!

Only circuits with limited power may be used for UL approved components according to "NEC Class 2".

Protection class	3 as per DIN EN 61140 (VDE 0140-1)	
Connections	Cable gland M16 x 1.5, SW22 (clamping area 5 ... 10 mm) with connection terminals for cable cross-sections 0.14 ... 1.5 mm ² (24 V DC) or circular plug-in connector (M12 x 1) (24 V DC, PROFIBUS DP, DeviceNet)	
Pilot valve		
Operating voltage	24 V DC ± 10 %, max. residual ripple 10 %	
Power consumption	< 5 W	
Input data for actual value signal		
4 ... 20 mA:	Input resistance	180 Ω
	Resolution	12 bit
Frequency:	Measurement range	0 ... 1000 Hz
	Input resistance	17 kΩ
	Resolution	1‰ of measurement value
	Input signal	> 300 mV _{ss}
	Waveform	sine, square, triangle
Pt 100:	Measurement range	-20 ... +220 °C
	Resolution	< 0.1 °C
	Measurement current	< 1 mA
Input data for set-point value signal		
0/4 ... 20 mA:	Input resistance	180 Ω
	Resolution	12 bit
0 ... 5/10 V:	Input resistance	19 kΩ
	Resolution	12 bit
Analogue feedback		
Max. current	10 mA (for voltage output 0 ... 5/10 V)	
Burden (load)	0 ... 560 Ω (for current output 0/4 ... 20 mA)	
30 Inductive proximity switches	100 mA current limitation	

Binary outputs Current limitation	galvanically isolated, PNP 100 mA, output is clocked if overload occurs
Binary input	galvanically isolated, PNP 0 ... 5 V = log "0", 10 ... 30 V = log "1" inverted input in reverse order (input current < 6 mA)
Communication interface	Direct connection to PC via USB adapter with integrated interface driver
Communications software	Communicator

10.9 Safety end positions after failure of the electrical or pneumatic auxiliary power

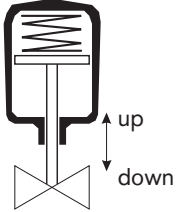
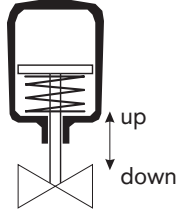
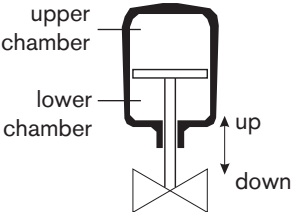
Actuator system	Designation	Safety end positions after failure of the	
		electrical auxiliary power	pneumatic auxiliary power
	single-acting Control function A	down	control system for high air flow rate (DN 2,5): down
			control system for low air flow rate (DN 0,6): not defined
	single-acting control function B	up	control system for high air flow rate (DN 2,5): up
			control system for low air flow rate (DN 0,6): not defined
	double-acting Control function I	down / up (depending on the installation of the pneumatic connection)	not defined

Table 7: Safety end position

10.10 Factory settings

The factory settings can be found in chapter “26. Operating structure and factory settings”, page 178.

The factory presets are highlighted in blue to the right of the menu in the operating structure.

Examples:





Representation	Description
	Menu options activated or selected at the factory
	
	Menu options not activated or selected at the factory
	
2.0 %	Values set at the factory
10.0 sec / ...	

Table 8: Illustration of the factory settings

11 ACCESSORIES

Designation	Order no.
Connection cable with M12 socket, 8-pole, (length 2 m)	919061
Connection cable with M12 socket, 4-pole, (length 5 m)	918038
Connection cable with M8 circular connector, 4-pole, (length 5 m)	92903475
Connection cable with M8 socket, 4-pole, (length 5 m)	92903474
USB adapter for connection to a PC in conjunction with an extension cable	227093
Communicator	Information at www.burkert.com
Screwing tool for opening/closing the transparent cap	674077

Table 9: Accessories

11.1 Communications software

The PC operating program “Communicator” is designed for communication with the devices from the Bürkert positioner family (valid since serial number 20000).



A detailed description and precise schedule of the procedure for the installation and operation of the software can be found in the associated documentation.

Download the software at: www.burkert.com

11.2 USB interface

The PC requires an USB interface for communication with the positioners as well as an additional adapter with interface driver (“Table 9: Accessories”).

The data transfer must be according to HART specification.

Installation

CONTENS

12	INSTALLATION	35
12.1	Installation of devices for the Ex area	35
12.2	Safety instructions	35
12.3	Installation on process valves Types 2103, 2300 and 2301	35
12.3.1	Install switch spindle.....	36
12.3.2	Install form seal	37
12.3.3	Install Type 8692/8693	38
12.4	Installation on process valves, series 26xx and 27xx.....	40
12.4.1	Install switch spindle.....	40
12.4.2	Install Type 8692/8693	41
12.5	Rotating the actuator module	43
12.6	Rotating the Types 8692/8693 for process valves belonging to series 26xx and 27xx.....	45
12.7	Pneumatic connection of the Type 8692/8693.....	46
12.8	Model with high air flow rate	47
12.8.1	Manual activation of the actuator via pilot valves.....	47
13	ELECTRICAL INSTALLATION 24 V DC.....	49
13.1	Electrical installation with circular plug-in connector.....	49
13.1.1	Safety instructions.....	49
13.1.2	X1 - M12 circular connector, 8-pole	50
13.1.3	X6 - M12 circular connector, 4-pole (operating voltage).....	51
13.1.4	X4 - M8, 4-pole socket (proximity switch) - option only	51
13.1.5	X5 - M8 circular connector, 4-pole - input signals process actual value (only Type 8693).....	52
13.2	Setting the proximity switch - optional.....	53
13.2.1	Removing housing jacket and electronic module	53
13.2.2	Setting the proximity switch.....	54
13.2.3	Installing electronics module and housing jacket	56
13.3	Electrical installation with cable gland.....	57
13.3.1	Safety instructions.....	57
13.3.2	Terminal assignment: Input signals from the control centre (e.g. PLC).....	58
13.3.3	Terminal assignment: Output signals to the control centre (e.g. PLC) - (required for analogue output and/or binary output option only).....	58

13.3.4	Terminal assignment: Process actual value input (only Type 8693)	59
13.3.5	Terminal assignment: Operating voltage.....	60
14	DISASSEMBLY OF TYPE 8692/8693.....	61
14.1	Disconnecting the pneumatic connections	61
14.2	Disconnecting electrical connections.....	62
14.3	Removing Type 8692/8693.....	62

12 INSTALLATION



Only for positioners and process controllers without pre-assembled process valve.

12.1 Installation of devices for the Ex area

When installing devices in the explosion-protected area, observe the “ATEX manual for use in the Ex area” enclosed with the Ex-devices.

12.2 Safety instructions



DANGER!

Risk of injury from high pressure in the system/device.

- ▶ Before working on the system or device, switch off the pressure and vent/drain lines.

Risk of injury due to electrical shock!

- ▶ Before reaching into the device or the equipment, switch off the power supply and secure to prevent reactivation!
- ▶ Observe applicable accident prevention and safety regulations for electrical equipment!



WARNING!

Risk of injury from improper assembly!

- ▶ Assembly may be carried out by authorized technicians only and with the appropriate tools!

Risk of injury from unintentional activation of the system and uncontrolled restart!

- ▶ Secure system against unintentional activation.
- ▶ Following assembly, ensure a controlled restart.

12.3 Installation on process valves Types 2103, 2300 and 2301

NOTE!

When mounting on process valves with a welded body, follow the installation instructions in the operating instructions for the process valve.

Procedure:

1. Attaching the switch spindle
see [page 36](#)
2. Installing the form seal
see [page 37](#)

} Not required for actuators with attached control head or actuators on which a control head has already been attached.

1. For installation of Type 8693/8693
see [page 38](#)

12.3.1 Install switch spindle



DANGER!

Risk of injury from high pressure in the system/device.

- ▶ Before loosening the lines and valves, turn off the pressure and vent the lines.

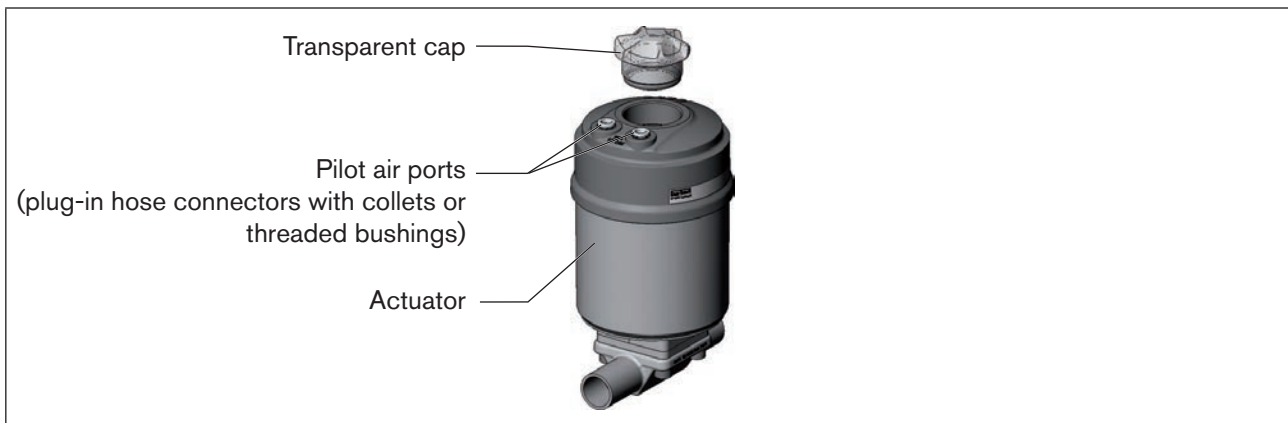


Figure 11: Installing the switch spindle for process valves Types 2103, 2300 and 2301; remove transparent cap and pilot air ports

- Unscrew the transparent cap on the actuator and unscrew the position display (yellow cap) on the spindle extension (if present).
- For version with plug-in hose connector, remove the collets (white nozzles) from both pilot air ports (if present).

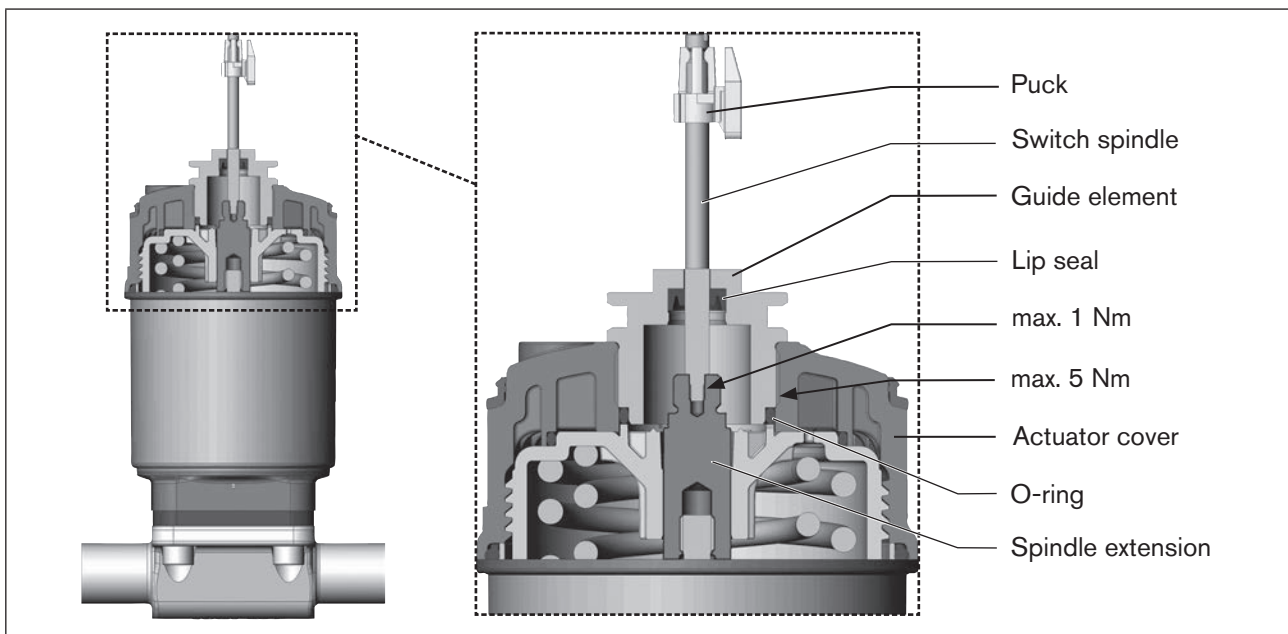


Figure 12: Attaching the switch spindle for process valves Types 2103, 2300 and 2301

NOTE!**Improper installation may damage the lip seal in the guide element!**

The lip seal is already pre-assembled in the guide element and must be “locked into position” in the undercut.

- ▶ When installing the switch spindle, do not damage the lip seal.

→ Push the switch spindle through the guide element.

NOTE!**Screw locking paint may contaminate the lip seal!**

- ▶ Do not apply any screw locking paint to the switch spindle.

→ To secure the switch spindle, apply some screw locking paint (Loctite 290) in the tapped bore of the spindle extension in the actuator.

→ Check that the O-ring is correctly positioned.

→ Screw the guide element to the actuator cover (maximum tightening torque: 5 Nm).

→ Screw switch spindle onto the spindle extension. To do this, there is a slot on the upper side (maximum tightening torque: 1 Nm).

→ Push puck onto the switch spindle and lock into position.

12.3.2 Install form seal

→ Pull the form seal onto the actuator cover (smaller diameter points upwards).

→ Check that the O-rings are correctly positioned in the pilot air ports.



When the Type 8692/8693 is being installed, the collets of the pilot air ports must not be fitted to the actuator.

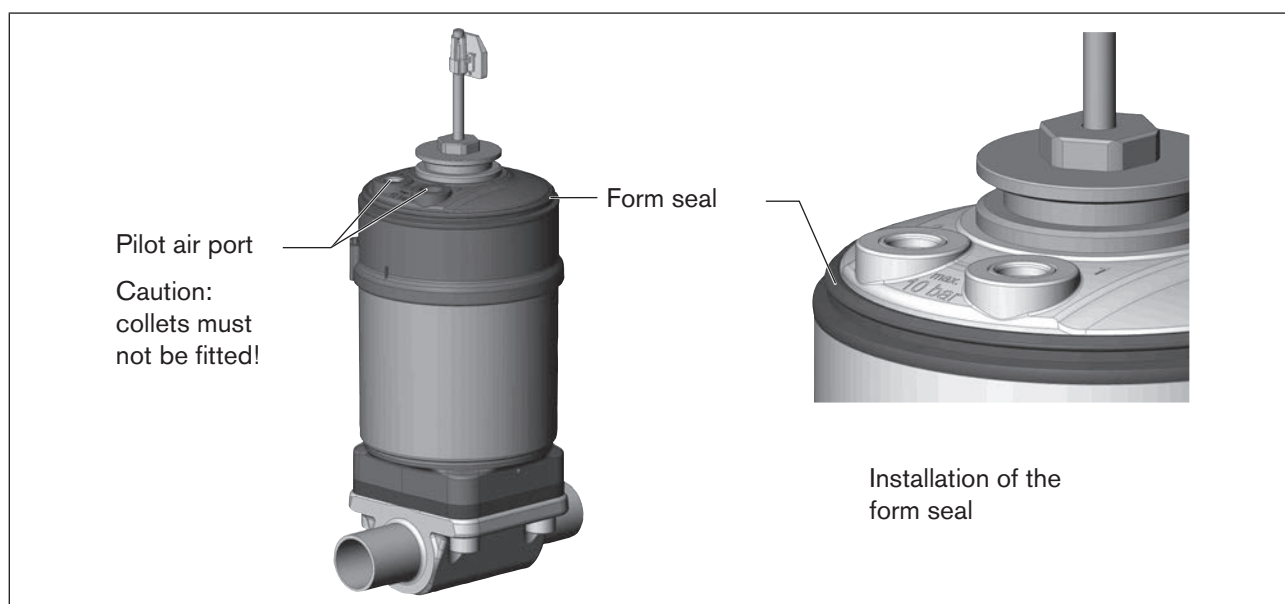


Figure 13: Installing the form seal for process valves Types 2103, 2300 and 2301

12.3.3 Install Type 8692/8693

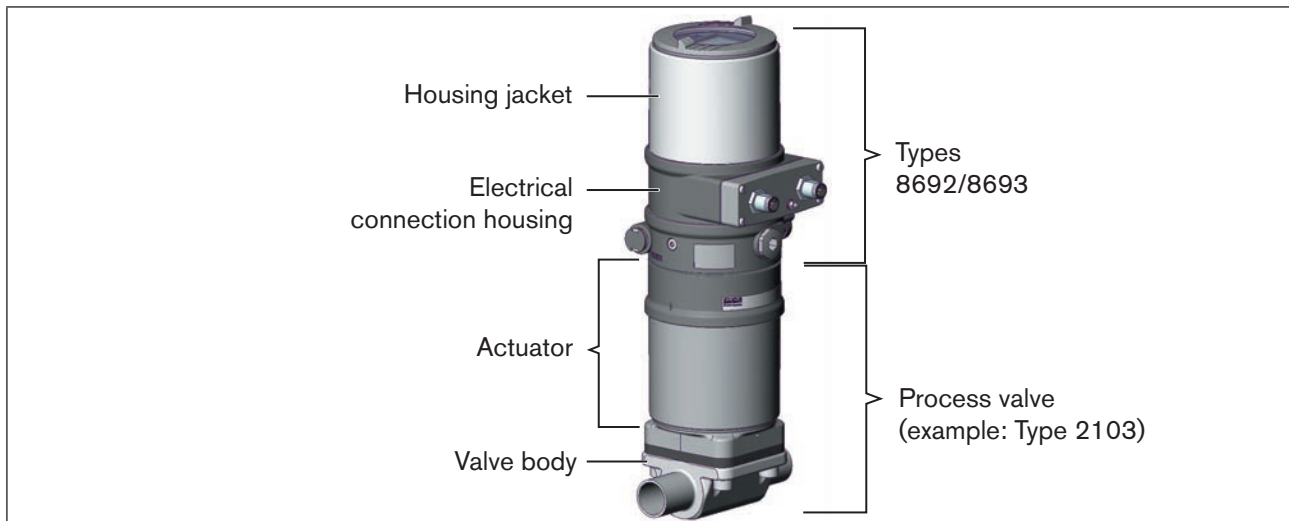


Figure 14: Installation of Type 8692/8693 on process valves, example showing Type 2301

! During the installation, the collets of the pilot air ports must not be fitted to the actuator.

→ Aligning actuator with type 8692/8693:

1. Align the pilot air ports of the actuator with the connection pieces of Type 8692/8693 (see "Figure 15").

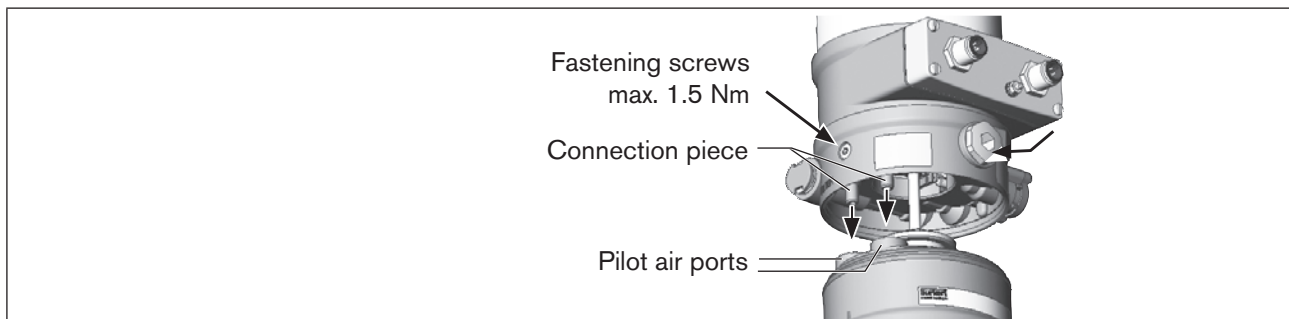


Figure 15: Aligning the pilot air ports

2. Align the puck of the actuator with the guide rail of Type 8692/8693 (see "Figure 16")

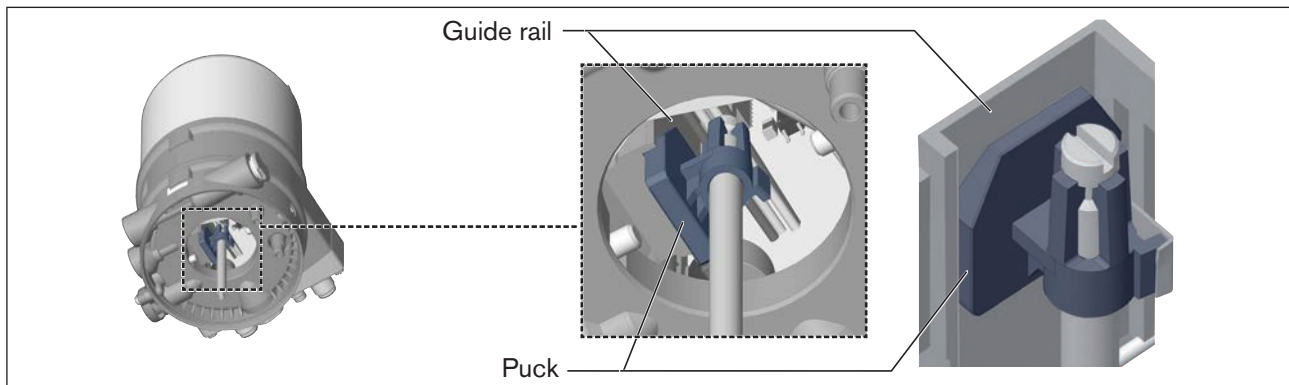


Figure 16: Aligning the puck

NOTE!

Damage to the PCB or malfunction!

- ▶ Ensure that the puck lies flat on the guide rail.

→ Push Type 8692/8693 without turning it onto the actuator until no gap is visible on the form seal.

NOTE!

To comply with the degree of protection IP65 / IP67, do not fasten the fastening screws too tightly.

- ▶ Maximum tightening torque: 1.5 Nm.

→ Attach Type 8692/8693 to the actuator using the two side fastening screws. In doing so, tighten the screws only hand-tight (max. tightening torque: 1.5 Nm)

12.4 Installation on process valves, series 26xx and 27xx

Procedure:

1. Attaching the switch spindle
Not required for actuators with attached control head or actuators on which a control head has already been attached.
2. Installation of Type 8693/8693

12.4.1 Install switch spindle

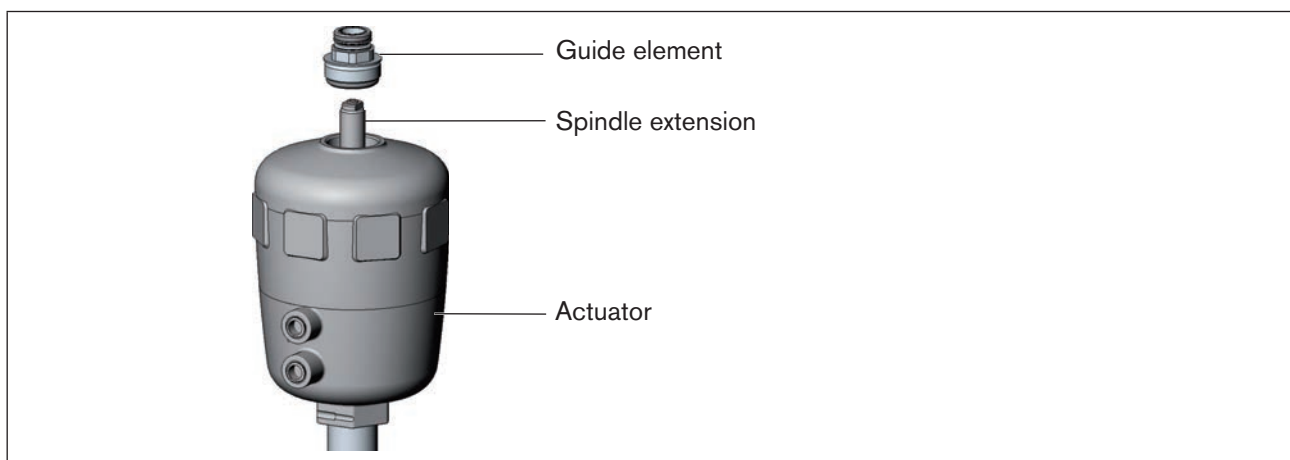


Figure 17: Installing the switch spindle for process valves belonging to series 26xx and 27xx; remove guide element and intermediate ring.

- Unscrew the guide element from the actuator (if present).
- Remove intermediate ring (if present).

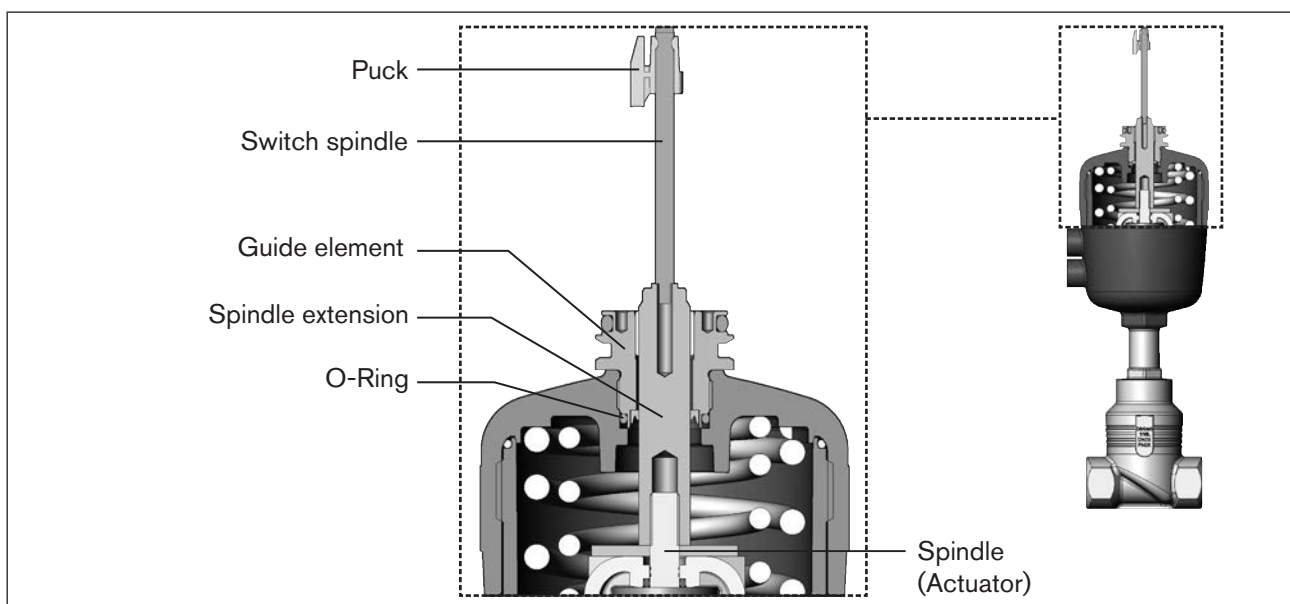


Figure 18: Installing the switch spindle for process valves belonging to series 26xx and 27xx

- Press the O-ring downwards into the cover of the actuator.
- Actuator size 125 and bigger with large air flow rate:
remove existing spindle extension and replace with the new one. To do this, apply some screw locking paint (Loctite 290) in the tapped bore of the spindle extension.
- With a face pin wrench (journal \varnothing : 3 mm / journal gap: 23.5 mm)
Screw the guide element into the cover of the actuator (tightening torque: 8.0 Nm).
- To secure the switch spindle, apply some screw locking paint (Loctite 290) to the thread of the switch spindle.
- Screw the switch spindle onto the spindle extension (maximum tightening torque: 1 Nm).
To do this, there is a slot on the upper side.
- Push the puck holder onto the switch spindle until it engages.

12.4.2 Install Type 8692/8693

- Place Type 8692/8693 onto the actuator. In doing so, align the puck of the actuator with the guide rail of Type 8692/8693 (see "Figure 19").

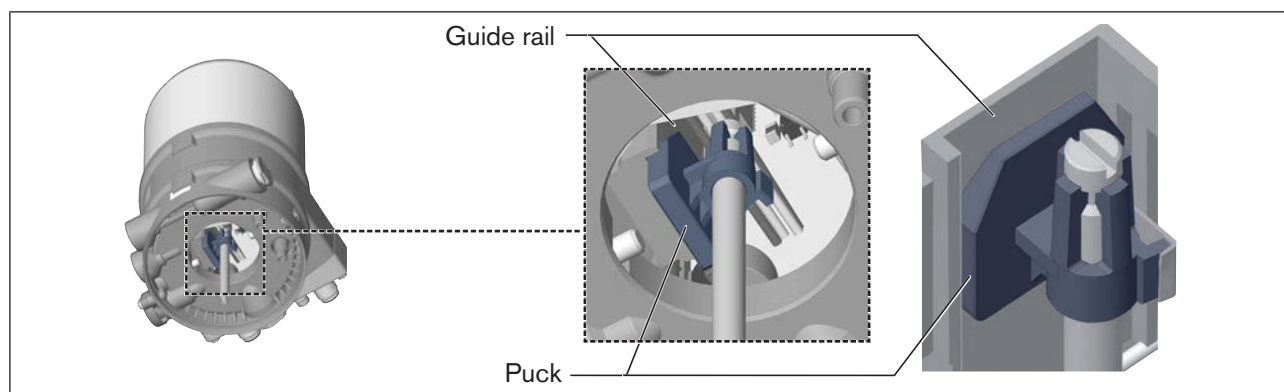


Figure 19: Aligning the puck

NOTE!

Damage to the PCB or malfunction!

- ▶ Ensure that the puck lies flat on the guide rail.

- Press Type 8692/8693 all the way down as far as the actuator and turn it into the required position.



Ensure that the pneumatic connections of Type 8692/8693 and those of the valve actuator are situated preferably vertically one above the other (see "Figure 20").

NOTE!

To comply with the degree of protection IP65 / IP67, do not fasten the fastening screws too tightly.

- ▶ Maximum tightening torque: 1.5 Nm.

- Attach Type 8692/8693 to the actuator using the two side fastening screws. In doing so, tighten the screws only hand-tight (max. tightening torque: 1.5 Nm).

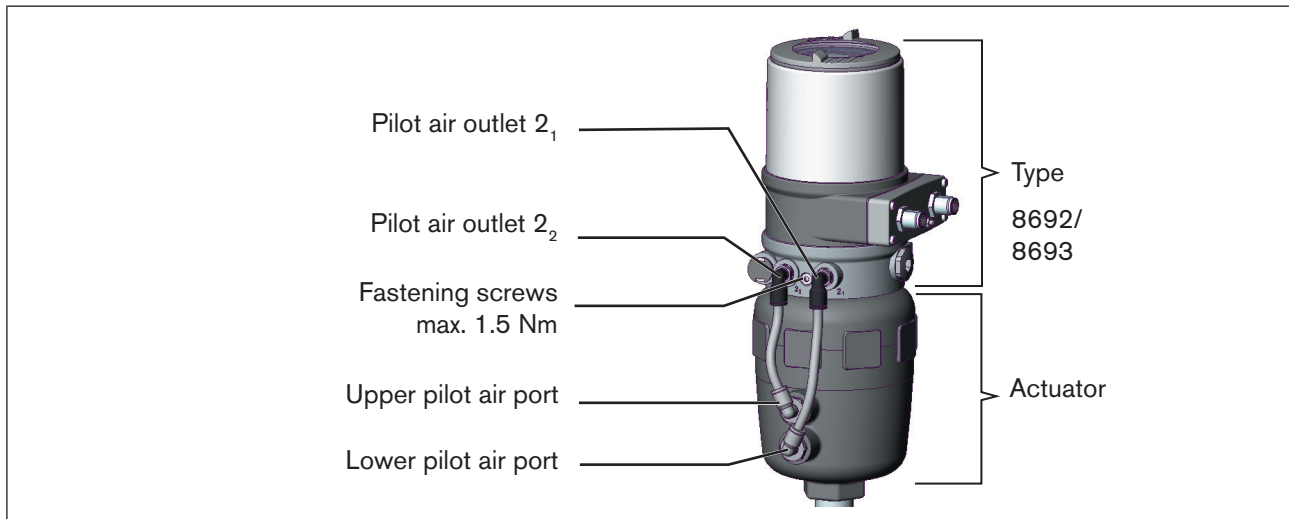


Figure 20: Installation of Type 8692/8693 on process valves belonging to series 26xx and 27xx

Establish the pneumatic connection between Type 8692/8693 and the actuator:

- Screw the plug-in hose connectors onto the Type 8692/8693 and the actuator.
- Observe the pneumatic connection that matches the desired control function. See [“Table 10: Pneumatic connection to actuator”](#).
- Using the hoses supplied in the accessory kit, make the pneumatic connection between Type 8693/8693 and the actuator.

NOTE!

Damage or malfunction due to ingress of dirt and moisture!

- ▶ To comply with the degree of protection IP65 / IP67, connect the pilot air outlet which is not required to the free pilot air port of the actuator or seal with a plug.



“In rest position” means that the pilot valves of Type 8692/ 8693 are isolated or not actuated.



If the ambient air is humid, a hose can be connected between pilot air outlet 2₂ of the positioner / process controller and the unconnected pilot air port of the actuator for control function A or control function B.

As a result, the spring chamber of the actuator is supplied with dry air from the vent duct of Type 8692/8693.

Control function		Pneumatic connection Type 8692, 8693 with actuator	
		Pilot air outlet Types 8692 and 8693	Pilot air port actuator
A	Process valve closed in rest position (by spring force)	2 ₁	lower pilot air port of the actuator
		2 ₂	should be connected to the upper pilot air port of the actuator
B	Process valve open in rest position (by spring force)	2 ₁	upper pilot air port of the actuator
		2 ₂	should be connected to the lower pilot air port of the actuator
I	Process valve closed in rest position	2 ₁	lower pilot air port of the actuator
		2 ₂	upper pilot air port of the actuator
	Process valve open in rest position	2 ₁	upper pilot air port of the actuator
		2 ₂	lower pilot air port of the actuator

Table 10: Pneumatic connection to actuator

12.5 Rotating the actuator module

Type 8692/8693 with attached actuator is designated as the actuator module.

Following installation of the process valve, if display of Type 8692/8693 is only partially visible or the connection cables or hoses are difficult to fit, the actuator module can be rotated into a suitable position.



With diaphragm valves it is not possible to turn the actuator module.



Process valves Types 2300 and 2301: Only the position of the entire actuator module relative to the valve body can be rotated. Type 8692/8693 cannot be rotated contrary to the actuator.



The process valve must be in the open position to turn the actuator module!



DANGER!

Risk of injury from high pressure in the system/device.

- ▶ Before loosening the lines and valves, turn off the pressure and vent the lines.

Procedure:

- Clamp valve body in a holding device (only required if the process valve has not yet been installed).
- Control function A: Open process valve.

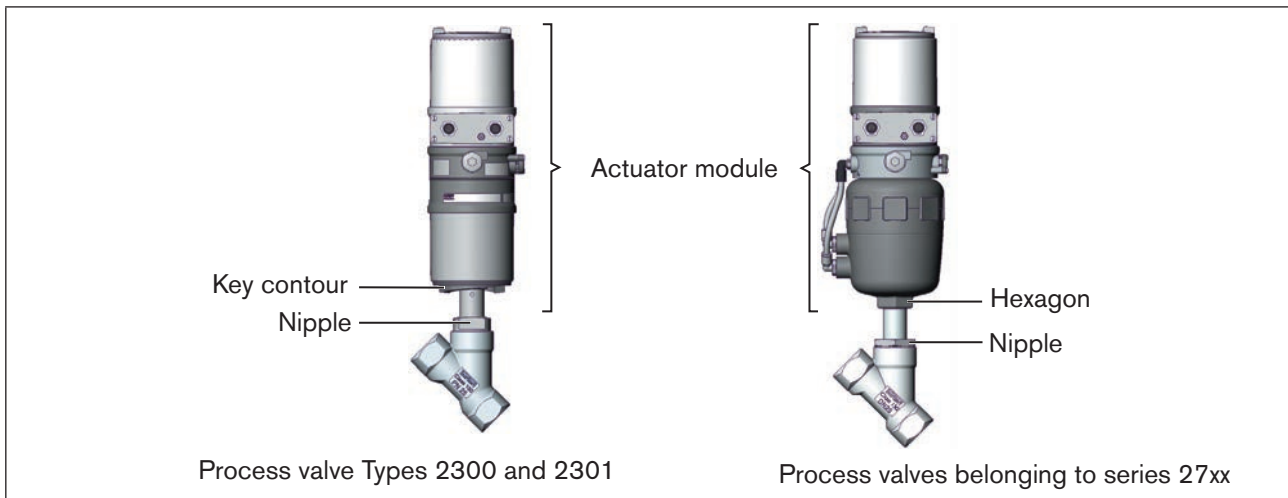


Figure 21: Rotating the actuator module

- Using a suitable open-end wrench, counter the wrench flat on the pipe.
- Process valves Types 2300 and 2301:
Spezienschlüssel genau in die Schlüsselkontur an der Unterseite des Antriebs einpassen.
(The special key is available from the Bürkert sales office. Order number 665702).
- Process valves belonging to series 27xx:
Place suitable open-end wrench on the hexagon of the actuator.



WARNING!

Risk of injury from discharge of medium and pressure!

If the direction of rotation is wrong, the body interface may become detached.

- ▶ The actuator module **must only be turned in the specified direction** (see [“Figure 22: Specified direction of rotation and tool for turning the actuator module”](#))!

- Process valves Types 2300 and 2301:
Rotate clockwise (as seen from below) to bring the actuator module into the required position.
- Process valves belonging to series 27xx:
Rotate counter-clockwise (as seen from below) to bring the actuator module into the required position.

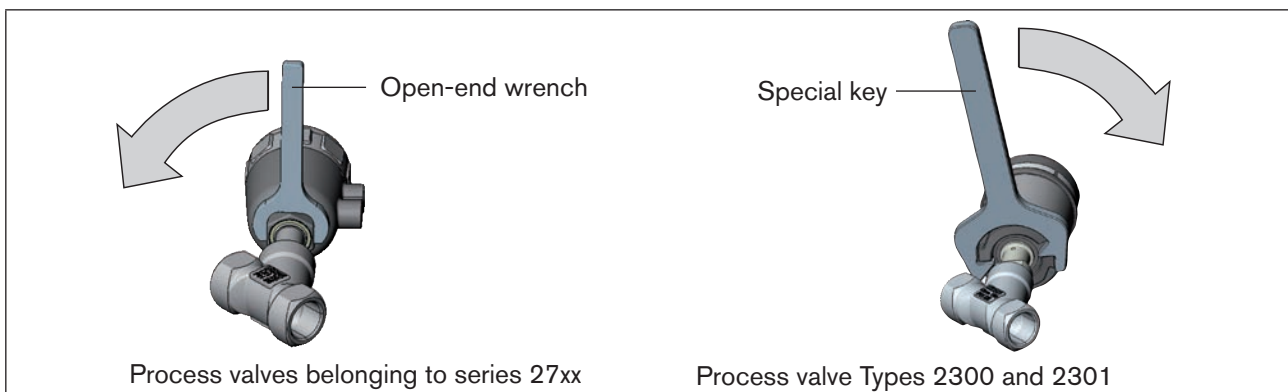


Figure 22: Specified direction of rotation and tool for turning the actuator module

12.6 Rotating the Types 8692/8693 for process valves belonging to series 26xx and 27xx

If the connecting cables or hoses cannot be fitted properly following installation of the process valve, the Type 8692/8693 can be rotated contrary to the actuator.

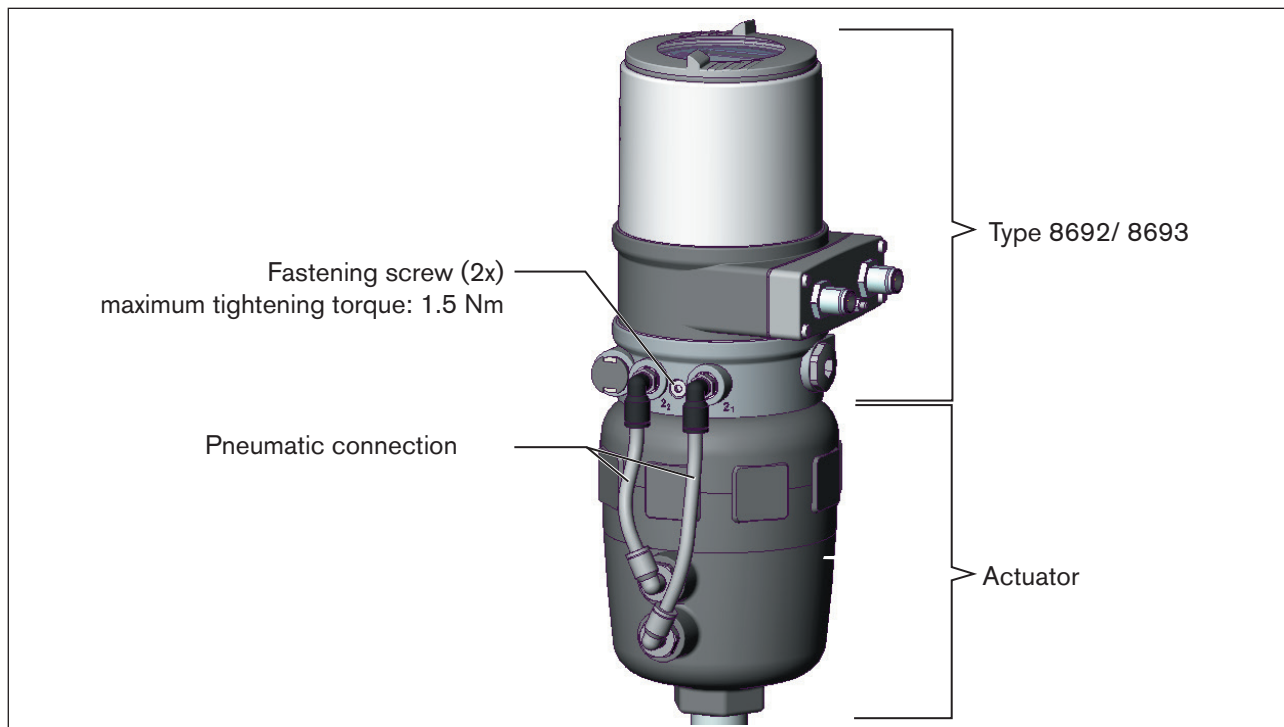


Figure 23: Rotating the Type 8692/8693 for process valves belonging to series 26xx and 27xx

Procedure:

- Loosen the pneumatic connection between the Type 8692/8693 and the actuator.
- Loosen the fastening screws (hexagon socket wrench size 3.0).
- Rotate the Type 8692/8693 into the required position.

NOTE!

To comply with the degree of protection IP65 / IP67, do not fasten the fastening screws too tightly.

- ▶ Maximum tightening torque: 1.5 Nm.

- Tighten the fastening screws hand-tight only (maximum tightening torque: 1.5 Nm).
- Re-attach the pneumatic connections between the Type 8692/8693 and the actuator. If required, use longer hoses.

12.7 Pneumatic connection of the Type 8692/8693



DANGER!

Risk of injury from high pressure in the system/device.

- ▶ Before working on the system or device, switch off the pressure and vent/drain lines.



Observe the following for the proper functioning of the device:

- ▶ The installation must not cause back pressure to build up.
- ▶ To make the connection, select a hose with sufficient cross section.
- ▶ Design the exhaust air line in such a way that no water or other liquid can get into the device through the exhaust air port (3 or 3.1).

Exhaust air concept:

- ▶ In compliance with the degree of protection IP67, an exhaust air line must be installed in the dry area.
- ▶ **Always** maintain an applied control pressure of at least 0.5 ... 1 bar above the pressure which is required to move the pneumatic actuator to its end position.
This ensures that the control behavior is not negatively affected in the upper stroke range on account of too little pressure difference.
- ▶ During operation, keep the fluctuations of the control pressure as low as possible (max. $\pm 10\%$).
If fluctuations are greater, the control parameters measured with the *X.TUNE* function are not optimum.

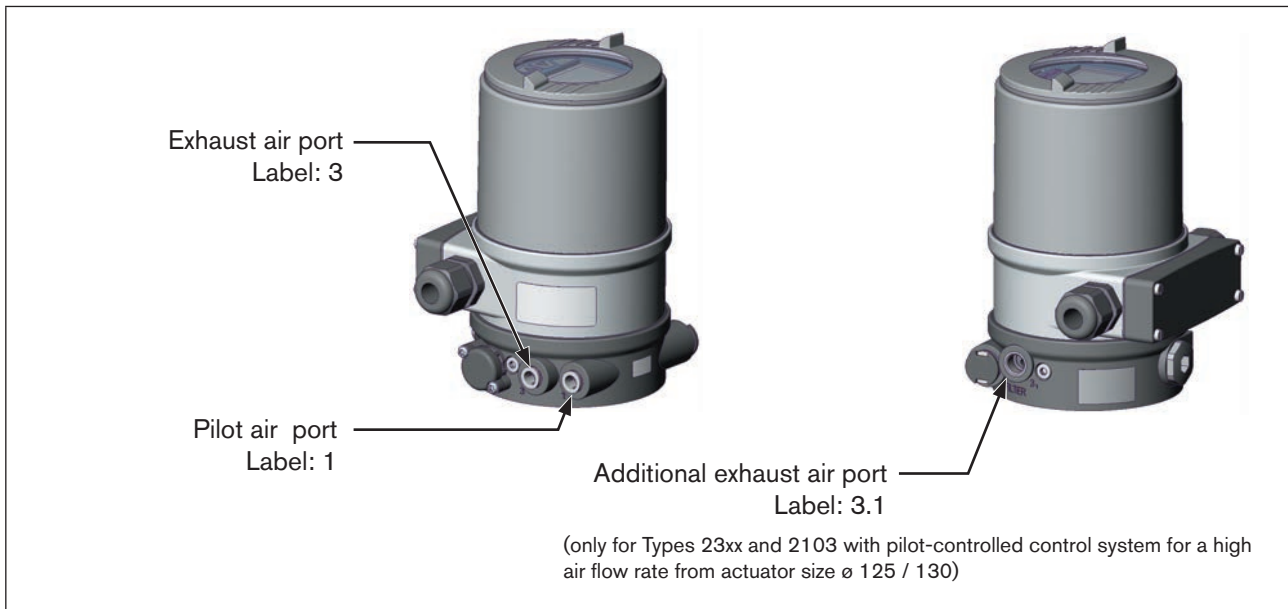


Figure 24: Pneumatic connection

Procedure:

- Connect the control medium to the pilot air port (1) (3 ... 7 bar; instrument air, free of oil, water and dust).
- Mount the exhaust air line or a silencer on the exhaust air port (3) and, if present, on the exhaust air port (3.1).

12.8 Model with high air flow rate

In the version with high air rate, the actuator can be moved to its end position without electrical power. The actuator moves from its rest position to the end position. To do this, the pilot valves must be activated with a screwdriver.

12.8.1 Manual activation of the actuator via pilot valves

The actuator can be moved from the rest position to its end position and back without electrical power. To do this, the pilot valves must be activated with a screwdriver.

NOTE!

The hand lever can be damaged if it is pressed and turned at the same time.

- ▶ Do not press the hand lever while turning it.

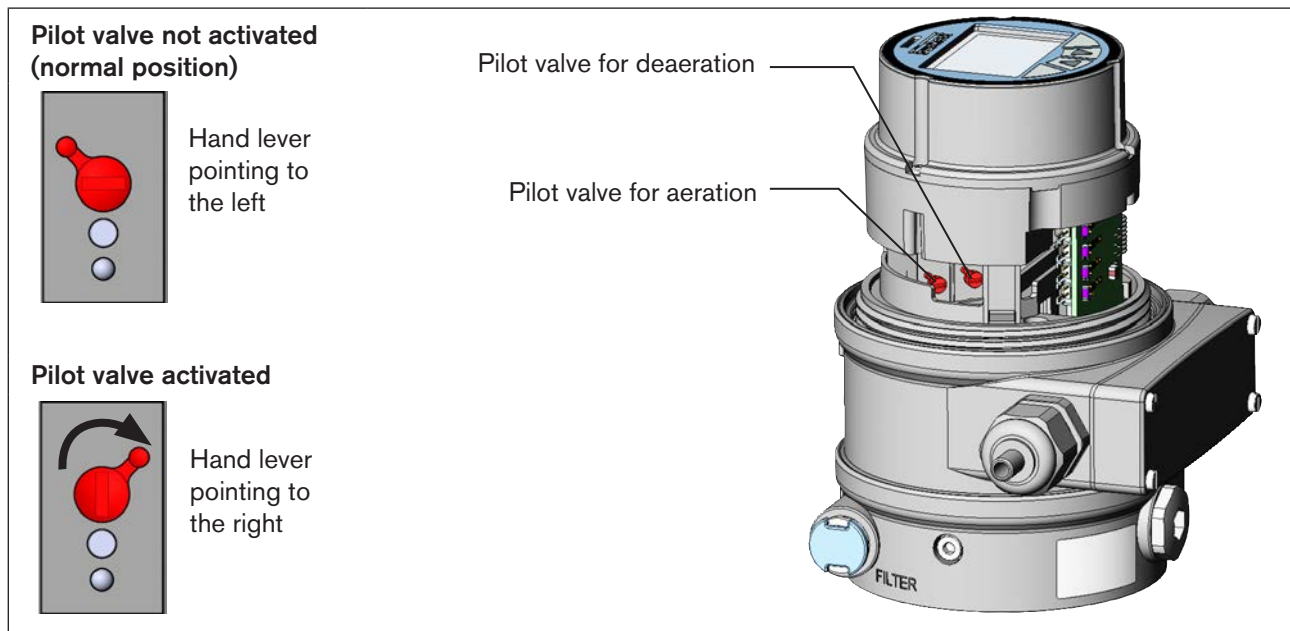


Figure 25: Pilot valves for aeration and deaeration of the actuator

Move the actuator to the end position

Turn the hand lever to the right with a screwdriver.

Please note: - Do not press the lever while turning it
- Follow the order described below

- 1. Activate the hand lever of the pilot valves for deaeration.
 - 2. Activate the hand lever of the pilot valves for aeration.
- Both hand levers are pointing to the right.
The actuator moves to the end position.

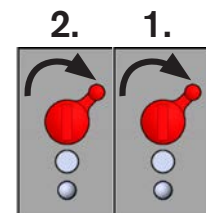


Figure 26: Move the actuator to the end position

Move the actuator back to the rest position

Turn the hand lever to the left with a screwdriver.

Please note: - Do not press the lever while turning it
- Follow the order described below

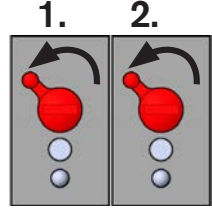
<p>→ 1. Activate the hand lever of the pilot valves for aeration.</p> <p>→ 2. Activate the hand lever of the pilot valves for deaeration.</p> <p>Both hand levers are pointing to the left (normal position).</p> <p>The actuator moves to the rest position by spring force.</p>	
---	---

Figure 27: Move the actuator back to the rest position

13 ELECTRICAL INSTALLATION 24 V DC

There are 2 connection options for Type 8692/8693:

- Multi-pole with circular plug-in connector
- Cable gland with connection terminals

Signal values

Operating voltage:	24 V DC
Set-point value (process/position controller):	0 ... 20 mA; 4 ... 20 mA 0 ... 5 V; 0 ... 10 V
Actual value (only process controller):	4 ... 20 mA; frequency; Pt 100

13.1 Electrical installation with circular plug-in connector

13.1.1 Safety instructions

DANGER!

Risk of injury due to electrical shock!

- ▶ Before reaching into the system, switch off the power supply and secure to prevent reactivation!
- ▶ Observe applicable accident prevention and safety regulations for electrical equipment!

WARNING!

Risk of injury from improper installation!

- ▶ Installation may be carried out by authorized technicians only and with the appropriate tools!

Risk of injury from unintentional activation of the system and uncontrolled restart!

- ▶ Secure system against unintentional activation.
- ▶ Following installation, ensure a controlled restart.

Using the 4 – 20 mA set-point value input

If several devices of Type 8692/8693 are connected in series and the power supply to a device in this series connection fails, the input of the failed device becomes highly resistive. As a result, the 4 – 20 mA standard signal fails. In this case please contact Bürkert Service directly.

If PROFIBUS DP or DeviceNet:

The designation of the circular plug-in connectors and sockets and the contacts can be found in the respective chapters.

Procedure:

→ Connect Type 8692/8693 according to the tables.

In designs with proximity switch:

Set the proximity switch (see [“13.2 Setting the proximity switch - optional”, page 53](#))

When the operating voltage is applied, Type 8692/8693 is operating.

→ Now make the required basic settings and adjustments for the positioner/process controller.

The procedure is described in chapter [“20 Start-up sequence”, page 78](#).

Designation of the circular plug-in connectors:

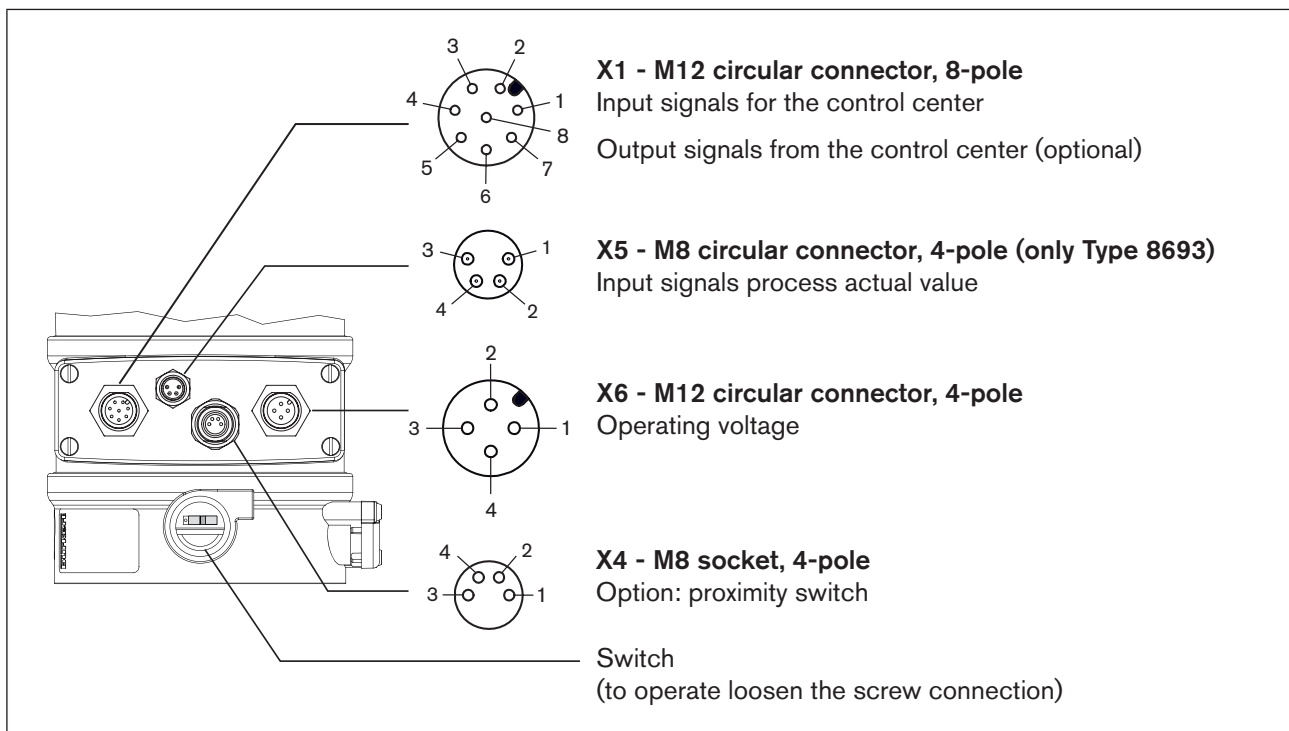







Figure 28: Electrical connection with 24 V DC circular plug-in connector

13.1.2 X1 - M12 circular connector, 8-pole

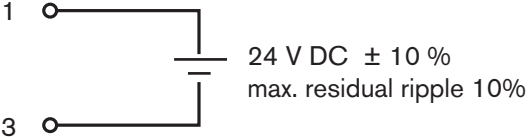
Pin	Wire color*	Configuration	On the device side	External circuit / Signal level
Input signals of the control centre (e.g. PLC)				
8	red	Set-point value + (0/4 ... 20 mA or 0 ... 5 / 10 V)	8	+ (0/4 ... 20 mA oder 0 ... 5 / 10 V) for operating voltage, galvanically isolated
7	blue	Set-point value GND	7	GND set-point value
1	white	Binary input +	1	+ 0 ... 5 V (log. 0) 10 ... 30 V (log. 1)

Pin	Wire color*	Configuration	On the device side	External circuit / Signal level
Output signals to the control centre (e.g. PLC) (required for analogue output and/or binary output option only)				
6	pink	Analog position feedback +	6 	+ (0/4 ... 20 mA or 0 ... 5 / 10 V) for operating voltage, galvanically isolated
5	gray	Analog position feedback GND	5 	GND Analog feedback
4	yellow	Binary output 1	4 	24 V / 0 V
3	green	Binary output 2	3 	24 V / 0 V
2	brown	Binary outputs GND	2 	GND

* The indicated wire colours refer to the connection cable, part no. 919061, available as an accessory.

Table 11: X1 - M12 circular connector, 8-pole

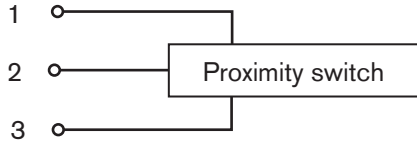
13.1.3 X6 - M12 circular connector, 4-pole (operating voltage)

Pin	Wire color*	Configuration	On the device side	External circuit / Signal level
1	brown	+24 V		
2		not used		
3	blue	GND		
4		not used		

* The indicated wire colours refer to the connection cable, part no. 918038, available as an accessory.

Table 12: X6 - M12 circular connector, 4-pole (operating voltage)


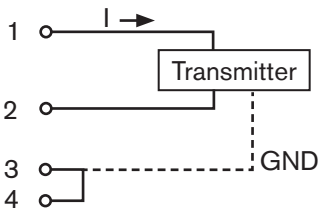




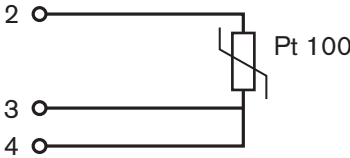
13.1.4 X4 - M8, 4-pole socket (proximity switch) - option only

Pin	Wire color*	Configuration	On the device side	External circuit / Signal level
1	brown	Proximity switch 1 out		
2	white	GND		
3	blue	+24 V DC		
4		not used		

* The indicated wire colours refer to the connection cable, part no. 92903475, available as an accessory.


Table 13: X4 - M8, 4-pole socket, proximity switch

13.1.5 X5 - M8 circular connector, 4-pole - input signals process actual value (only Type 8693)

input type*	Pin	Wire color **	Assignment	Switch ***	On the device side	External circuit
4 ... 20 mA - internally supplied	1 2 3 4	brown white blue black	+24 V supply transmitter Output of transmitter GND (identical with GND operating voltage) Bridge to GND (GND from 3-wire transmitter)	 Switch on left		
4 ... 20 mA - externally supplied	1 2 3 4	brown white blue black	not assigned Process actual + not assigned Process actual -	 Switch on right	2 4	4 ... 20 mA GND 4 ... 20 mA
Frequenz - internally supplied	1 2 3 4	brown white blue black	+24 V sensor supply Clock input + Clock input - (GND) not assigned	 Switch on left	1 2 3	+24 V Clock + Clock - / GND (identical with GND operating voltage)
Frequenz - externally supplied	1 2 3 4	brown white blue black	not assigned Clock input + Clock input - not assigned	 Switch on right	2 3	Clock + Clock -
Pt 100 (see note below)	1 2 3 4	brown white blue black	not assigned Process actual 1 (current feed) Process actual 3 (GND) Process actual 2 (compensation)	 Switch on right	2 3 4	

* Can be adjusted via software (see chapter "24.2.1 PV-INPUT – Specifying signal type for the process actual value").
 ** The indicated colors refer to the connection cable available as an accessory (92903474).
 *** Position of the switch, see "Figure 28: Electrical connection with 24 V DC circular plug-in connector".

Table 14: X5 - M8 circular connector, 4-pole - input signals process actual value (only Type 8693)

NOTE!
 For reasons of wire resistance compensation, connect the Pt 100 sensor via 3 wires. Always bridge Pin 3 and Pin 4 on the sensor.

When the operating voltage is applied, the Type 8692/8693 is operating.

→ Now make the required basic settings and actuate the automatic adjustment of the positioner/process controller. The procedure is described in chapter "20 Start-up sequence".

MAN 1000108626 EN Version: F Status: RL (released | freigegeben) printed: 20.01.2015

13.2 Setting the proximity switch - optional



DANGER!

Risk of injury due to electrical shock!

- ▶ Before reaching into the system, switch off the power supply and secure to prevent reactivation!
- ▶ Observe applicable accident prevention and safety regulations for electrical equipment!

13.2.1 Removing housing jacket and electronic module

→ ⚠ Disconnect operating voltage at Type 8692/8693 and proximity switch connector

NOTE!

Breakage of the pneumatic connection pieces due to rotational impact!

- ▶ When unscrewing the housing jacket, **do not hold the actuator** but the electrical connection housing above.

→ Hold the electrical connection housing in place.

→ Unscrew the housing jacket in a counter-clockwise direction and remove.

→ Remove electronics module.

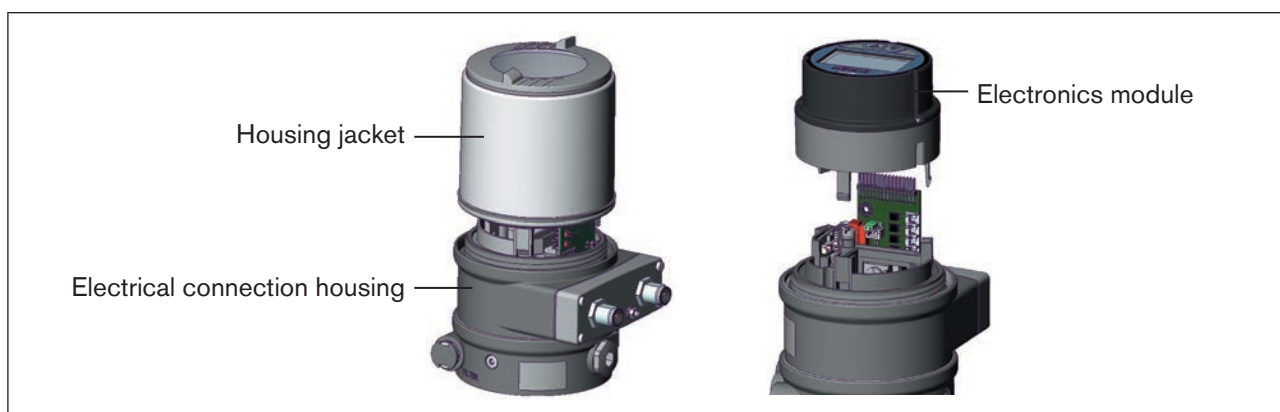


Figure 29: Removing housing jacket and electronics module.

13.2.2 Setting the proximity switch



The proximity switch can be set to the bottom or the top end position. The handling of the settings differs for the various control functions.

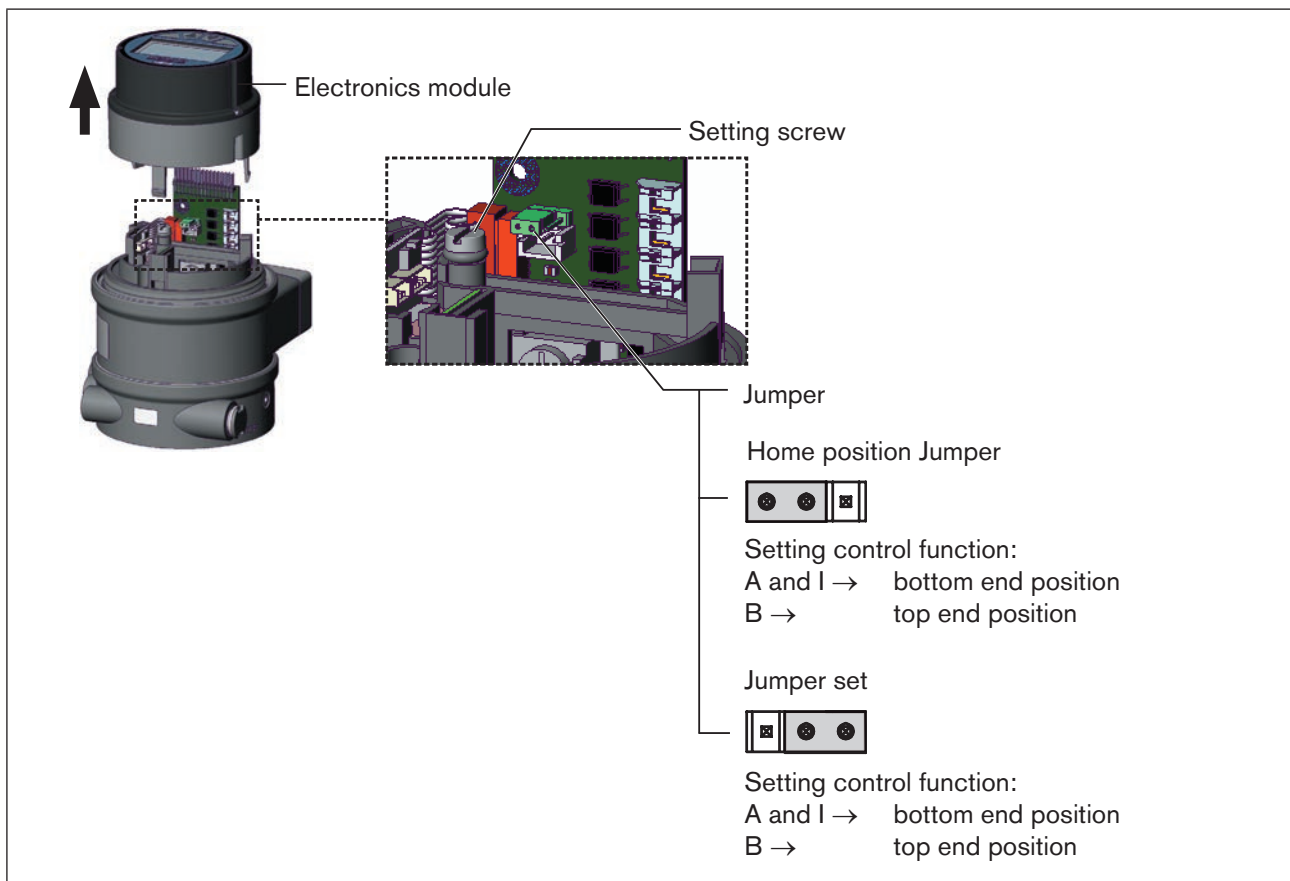


Figure 30: Setting the proximity switch

**Bottom end position for control function A or
top end position for control function B**

- Switch on operating voltage at the proximity switch connector.
- Using a screwdriver, set proximity switch at the setting screw to end position.
- ⚠ Switch off operating voltage at the proximity switch connector.

Bottom end position for control function I

→ Connect the pilot air.



WARNING!

Valve moves after electrical voltage has been connected!

After connecting the electrical voltage, the actuator moves to the set end position!

▶ Never adjust the proximity switch while the process is running!

→ Connect operating voltage at Type 8692/8693 and proximity switch connector.

→ Move actuator to the bottom end position.

→ Using a screwdriver, set proximity switch at the setting screw to end position.

→ ⚠ Switch off the pilot air.

→ ⚠ Disconnect operating voltage at Type 8692/8693 and proximity switch connector.

Top end position for control function A and I or bottom end position for control function B

→ Set jumper (see "[Figure 30: Setting the proximity switch](#)").

→ Connect the pilot air.



WARNING!

Valve moves after electrical voltage has been connected!

After connecting the electrical voltage, the actuator moves to the set end position!

▶ Never adjust the proximity switch while the process is running!

→ Connect operating voltage at Type 8692/8693 and proximity switch connector.

→ Move valve to the top end position (for control function A and I) or bottom end position (for control function B).

→ Using a screwdriver, set proximity switch at the setting screw to end position.

→ ⚠ Switch off the pilot air.

→ ⚠ Switch off operating voltage at the device and the proximity switch connector.

→ Return jumper to home position ("[Figure 30](#)").

13.2.3 Installing electronics module and housing jacket

NOTE!

Be careful not to damage the pins at the PCB!

- Position the electronics module straight and do not tilt when pressing down.

→ Attach electronics module carefully and press down evenly until the holders snap into place.

→ Check that the seal is correctly positioned on the housing jacket.

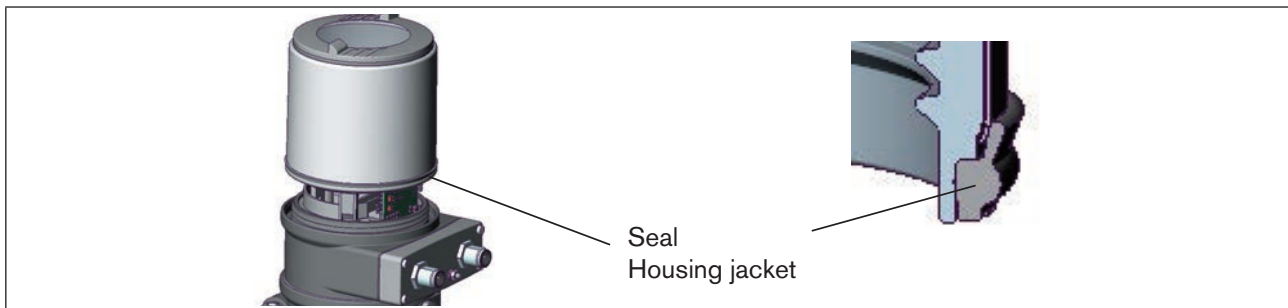


Figure 31: Position seal housing jacket

NOTE!

Breakage of the pneumatic connection pieces due to rotational impact!

- ▶ When inserting the housing jacket, **do not hold the actuator** but the electrical connection housing above.

→ Place the housing jacket over the electronics module and screw it in until the stop position; while doing so, hold the electrical connection housing (screwing tool available via the Bürkert Sales Center. Order number 674077).

NOTE!

Malfunction due to ingress of dirt and moisture!

To comply with the degree of protection IP65 / IP67, make sure that the housing jacket and the electrical connection housing are screwed together tightly.

→ Switch on operating voltage at the device and the proximity switch connector.

→ Restart operation of Type 8692/8693.

13.3 Electrical installation with cable gland

13.3.1 Safety instructions



DANGER!

Risk of injury due to electrical shock!

- ▶ Before reaching into the system, switch off the power supply and secure to prevent reactivation!
- ▶ Observe applicable accident prevention and safety regulations for electrical equipment!



WARNING!

Risk of injury from improper installation!

- ▶ Installation may be carried out by authorized technicians only and with the appropriate tools!

Risk of injury from unintentional activation of the system and uncontrolled restart!

- ▶ Secure system against unintentional activation.
- ▶ Following installation, ensure a controlled restart.



Using the 4 – 20 mA set-point value input

If several devices of Type 8692/8693 are connected in series and the power supply to a device in this series connection fails, the input of the failed device becomes highly resistive. As a result, the 4 – 20 mA standard signal fails. In this case please contact Bürkert Service directly.

Vorgehensweise:

- Loosen the 4 screws of the connection cover and remove the cover. The connection terminals are now accessible.
- Push the cables through the cable gland.
- Connect the wires. The terminal assignment can be found in the tables below.
- Tighten the union nut of the cable gland (tightening torque approx. 1.5 Nm).
- Place the connection cover with inserted seal onto the electrical connection housing and tighten cross-wise (tightening torque max. 0.7 Nm).

NOTE!

Damage or malfunction due to ingress of dirt and moisture!

To comply with the degree of protection IP65 / IP 67:

- ▶ Close all unused cable glands with dummy plugs.
- ▶ Tighten the union nut of the cable gland.
Tightening torque depends on cable size or dummy plug approx. 1.5 Nm.
- ▶ Only screw on connection cover with the seal inserted. Tightening torque max. 0.7 Nm.

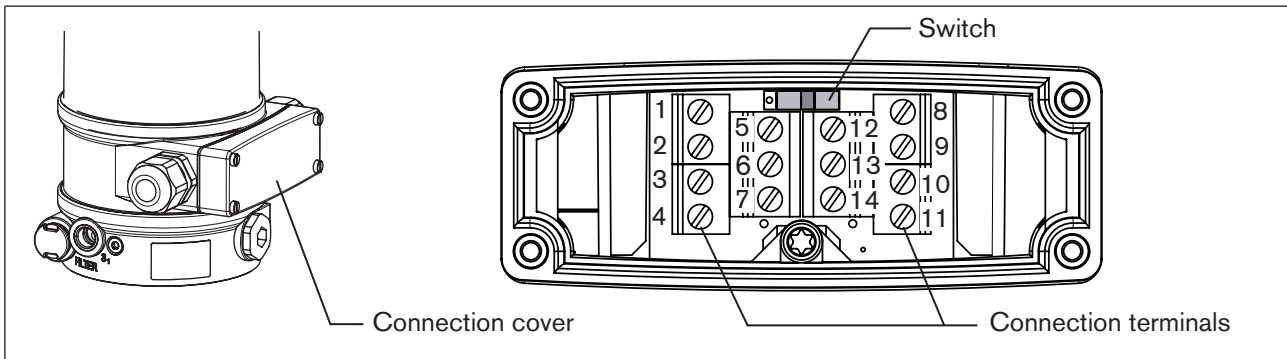


Figure 32: Cable gland connection

13.3.2 Terminal assignment: Input signals from the control centre (e.g. PLC)

Terminal	Assignment	On the device side	External circuit / Signal level
11	Set-point value +	11	+ (0/4 ... 20 mA or 0 ... 5 / 10 V) for operating voltage, galvanically isolated
10	Set-point value GND	10	GND Set-point value
12	Binary input +	12	+
13	Binary input GND	13	GND specific to operating voltage GND (terminal GND)


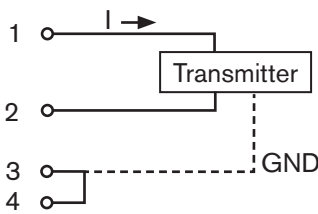

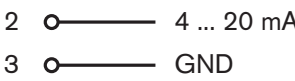

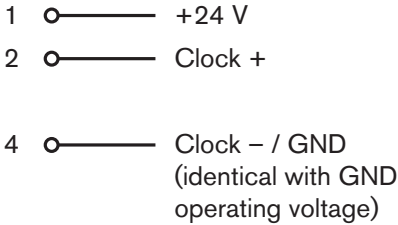

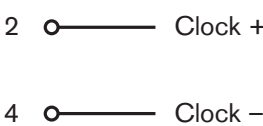

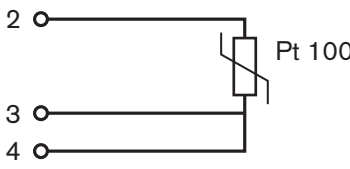
Table 15: Terminal assignment; input signals of the control centre

13.3.3 Terminal assignment: Output signals to the control centre (e.g. PLC) - (required for analogue output and/or binary output option only)

Terminal	Assignment	On the device side	External circuit / Signal level
9	Analog position feedback +	9	+ (0/4 ... 20 mA oder 0 ... 5 / 10 V) for operating voltage, galvanically isolated
8	Analog position feedback GND	8	GND Analoge Rückmeldung
5	Binary output 1	5	24 V / 0 V, NC / NO specific to operating voltage GND (terminal GND)
6	GND	6	GND
7	Binary output 2	7	24 V / 0 V, NC / NO specific to operating voltage GND (terminal GND)
6	GND	6	GND

Table 16: Terminal assignment; output signals to the control centre

13.3.4 Terminal assignment: Process actual value input (only Type 8693)

Input type*	Terminal	Assignment	Switch **	On the device side	External circuit
4 ... 20 mA - internally supplied	1 2 3 4	+24 V supply transmitter Output of transmitter Bridge to GND (GND from 3-wire transmitter) GND (identical with GND operating voltage)	 Switch on left		
4 ... 20 mA - externally supplied	1 2 3 4	not assigned Process actual + Process actual - not assigned	 Switch on right		
Frequency - internally supplied	1 2 3 4	+24 V supply sensor Clock input + not assigned Clock input - (GND)	 Switch on left		
Frequency - externally supplied	1 2 3 4	not assigned Clock input + not assigned Clock input -	 Switch on right		
Pt 100 *** (see note)	1 2 3 4	not assigned Process actual 1 (current feed) Process actual 2 (compensation) Process actual 3 (GND)	 Switch on right		

* Can be adjusted via software (see chapter "24.2.1 PV-INPUT – Specifying signal type for the process actual value").
 ** The switch is situated under the connection cover (see "Figure 32: Cable gland connection")

Table 17: Terminal assignment; process actual value input (only Type 8693)



*** For reasons of wire resistance compensation, connect the Pt 100 sensor via 3 wires.
Always bridge terminal 3 and terminal 4 on the sensor.

13.3.5 Terminal assignment: Operating voltage

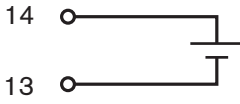
Terminal	Assignment	On the device side	External circuit / Signal level
14	Operating voltage +24 V	14	 <p>24 V DC \pm 10 % max. residual ripple 10%</p>
13	Operating voltage GND	13	

Table 18: Terminal assignment; operating voltage

When the operating voltage is applied, the Type 8692/8693 is operating.

→ Now make the required basic settings and actuate the automatic adjustment of the positioner/process controller. The procedure is described in chapter [“20 Start-up sequence”](#).

14 DISASSEMBLY OF TYPE 8692/8693

WARNING!

Risk of injury from improper disassembly!

- ▶ Disassembly may be carried out by authorized technicians only and with the appropriate tools!

Risk of injury from unintentional activation of the system and uncontrolled restart!

- ▶ Secure system against unintentional activation.
- ▶ Following disassembly, ensure a controlled restart.

Sequence:

1. Remove the pneumatic connections.
2. Disconnect the electrical connection.
3. Remove Type 8692/8693.

14.1 Disconnecting the pneumatic connections

DANGER!

Risk of injury from high pressure!

- ▶ Before loosening lines and valves, turn off the pressure and vent the lines.

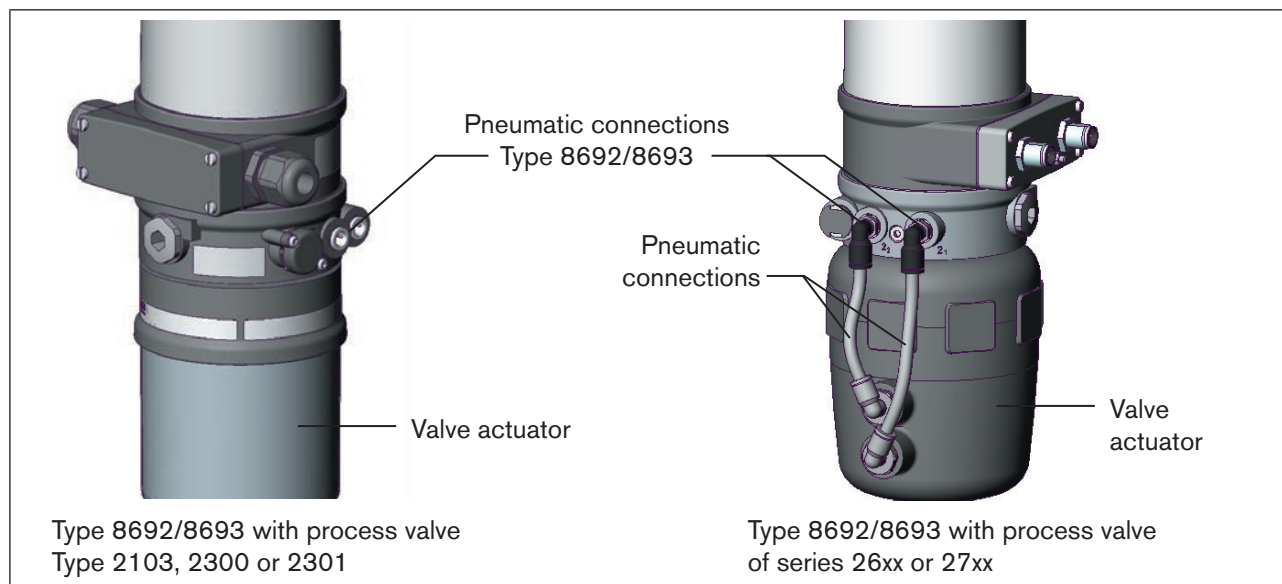


Figure 33: Removing the pneumatic connections

→ Disconnect the pneumatic connections to Type 8693/8693.

For process valves belonging to series 26xx and 27xx:

→ Disconnect the pneumatic connections to the actuator.

14.2 Disconnecting electrical connections

DANGER!

Risk of injury due to electrical shock!

- ▶ Before reaching into the device or the equipment, switch off the power supply and secure to prevent reactivation!
- ▶ Observe applicable accident prevention and safety regulations for electrical equipment!

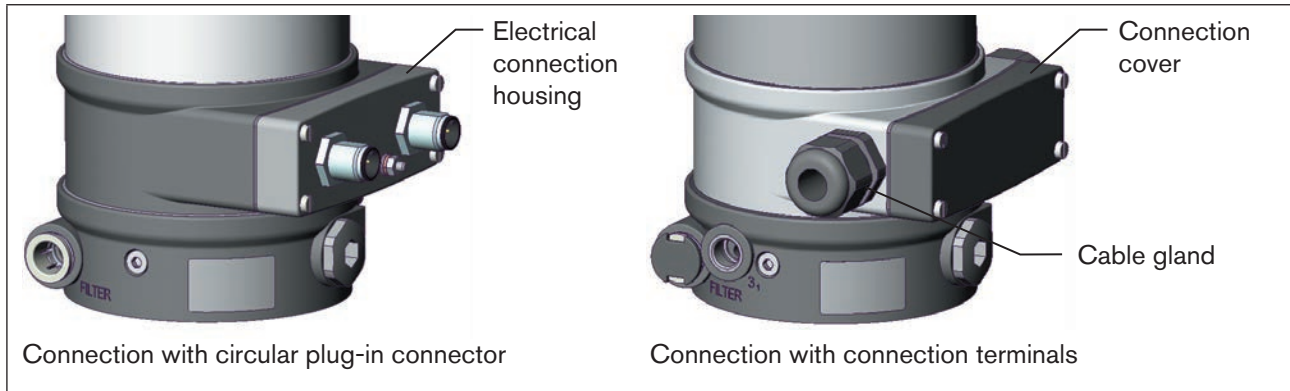


Figure 34: Disconnecting electrical connections

Connection with circular plug-in connector:

- Remove circular plug-in connector.

Connection with connection terminals:

- Loosen the 4 screws of the connection cover and remove the cover.
- Loosen the connection terminals and pull out the cable.

14.3 Removing Type 8692/8693

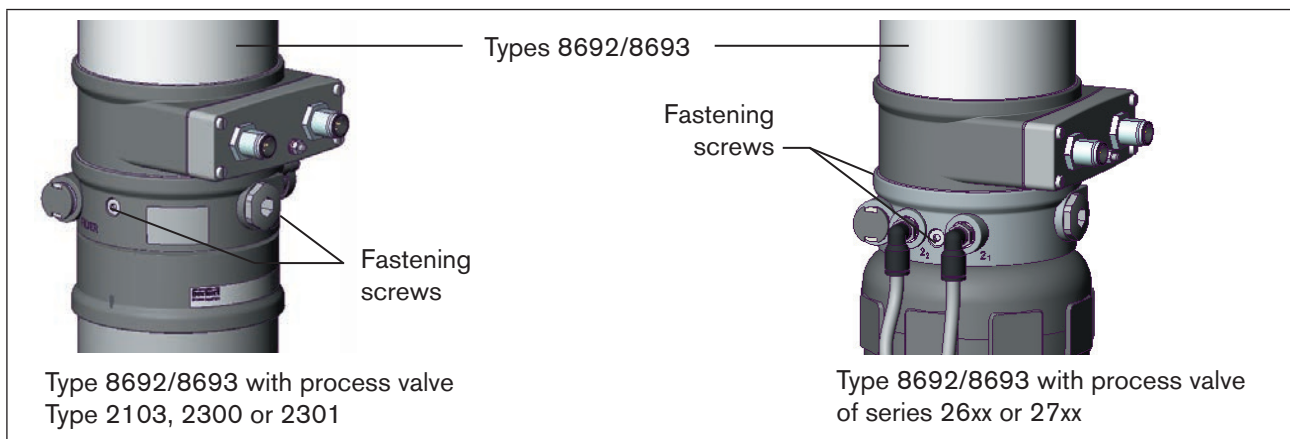


Figure 35: Disconnect electrical connections.

- Release the fastening screws.
- Remove Type 8692/8693.

Operation

CONTENTS

15	OPERATING LEVELS.....	64
	15.1 Switching between the operating levels	64
16	OPERATING AND DISPLAY ELEMENTS.....	65
	16.1 Description of the operating and display elements.....	65
	16.1.1 Description of the symbols which are displayed on the process level.....	66
	16.2 Function of the keys.....	67
	16.2.1 Entering and changing numerical values	68
	16.3 Adjusting the display	69
	16.3.1 Possible displays of the process level.....	69
	16.4 Date and time.....	71
	16.4.1 Setting date and time:.....	72
17	OPERATING STATES	73
	17.1 Changing the operating state.....	73
18	ACTIVATING AND DEACTIVATING AUXILIARY FUNCTIONS.....	74
	18.1.1 Activating auxiliary functions.....	74
	18.1.2 Deactivating auxiliary functions	75
19	MANUALLY OPENING AND CLOSING THE VALVE.....	76

15 OPERATING LEVELS

There is the process level and the setting level for the operation and setting of type 8692/8693.

Process level:

The running process is displayed and operated on the process level.

Operating state: AUTOMATIC – Displaying the process data
 MANUAL – Manually opening and closing the valve

Setting level:

The basic settings for the process are made on the setting level.

- Inputting the operating parameters
- Activating auxiliary functions

! If the device is in the AUTOMATIC operating state when changing to the setting level, the process continues running during the setting.

15.1 Switching between the operating levels

Change to the setting level	MENU	 Press for 3 seconds
Return to the process level	EXIT	 Press briefly

! The set MANUAL or AUTOMATIC operating state is retained even when the operating level is changed.

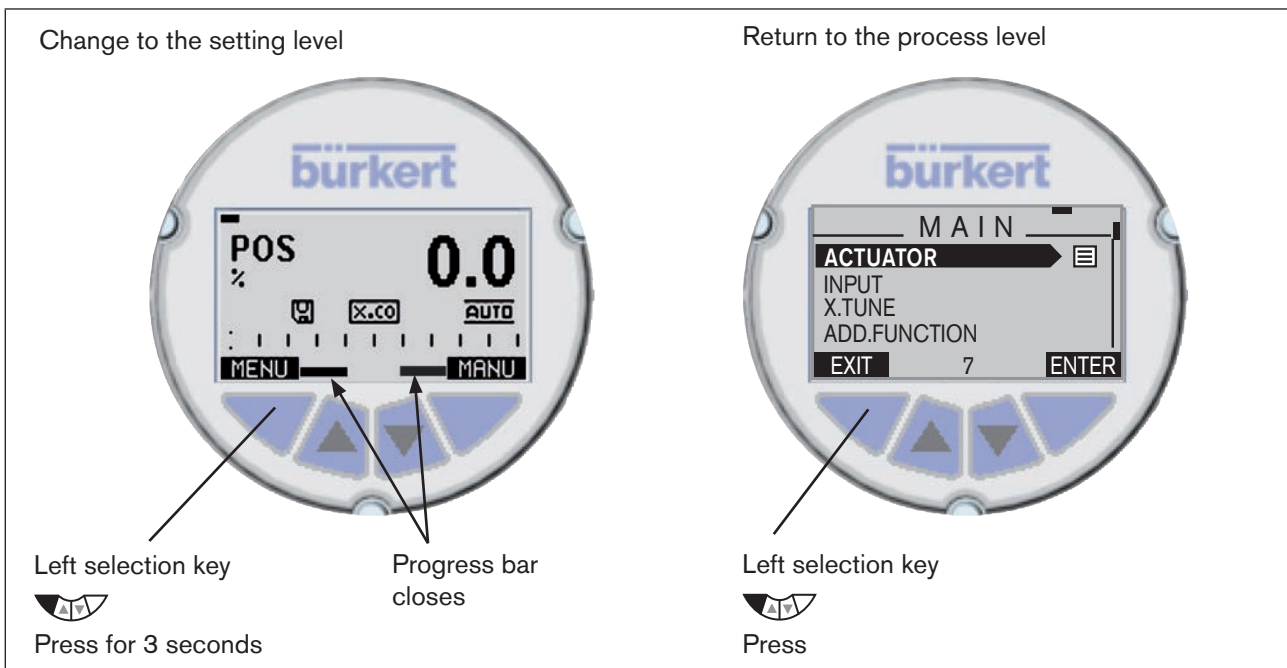


Figure 36: Changing operating level

16 OPERATING AND DISPLAY ELEMENTS

The following chapter describes the operating and display elements of Type 8692/8693.

16.1 Description of the operating and display elements

The device is operated by four keys and a 128x64 dot matrix graphics display.

The display is adjusted to the set functions and operating levels.

In principle, a distinction can be made between the display view for the process level and the setting level.

When the operating voltage has been applied, the process level is displayed.

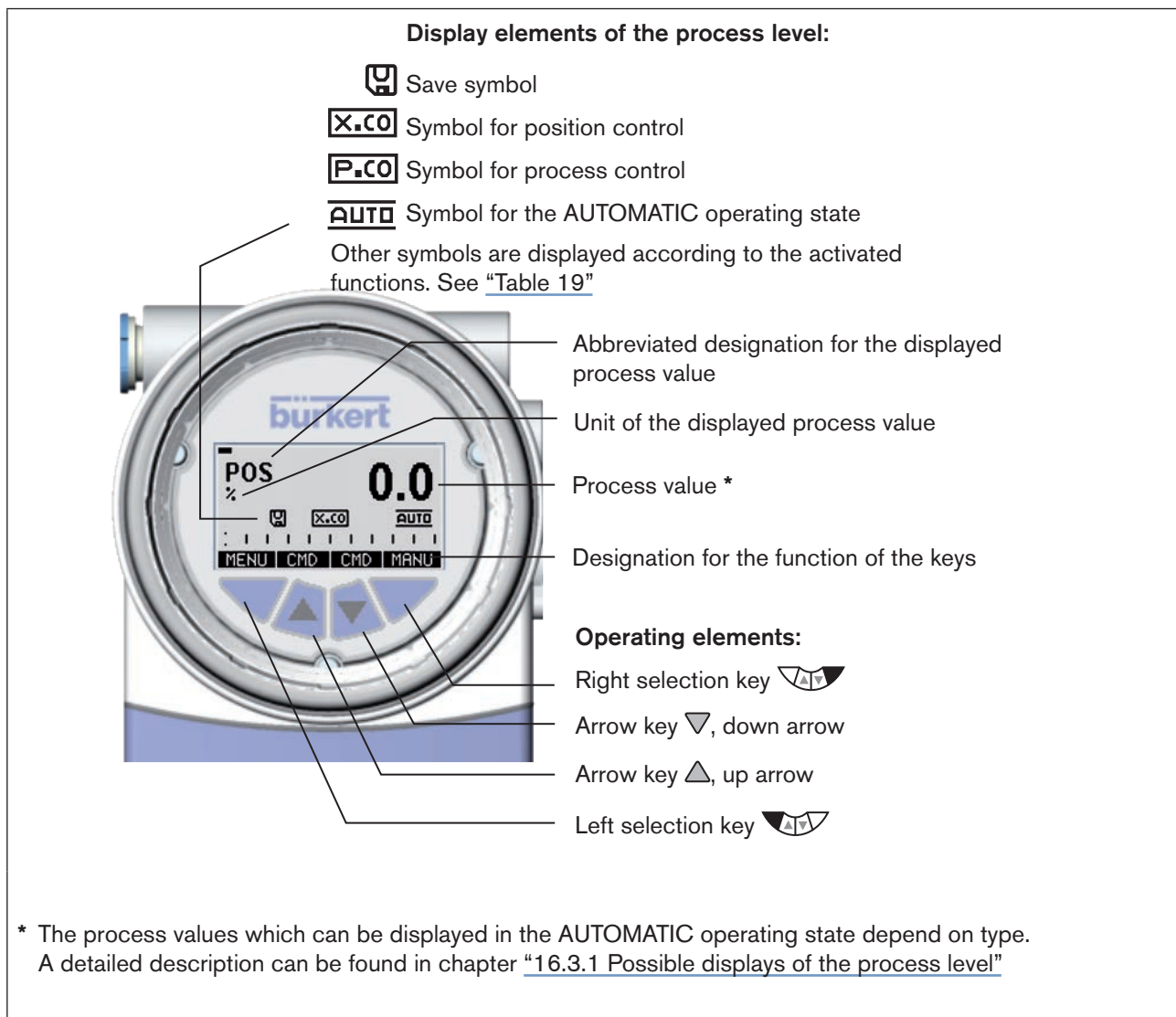


Figure 37: Display and operating elements of the process level

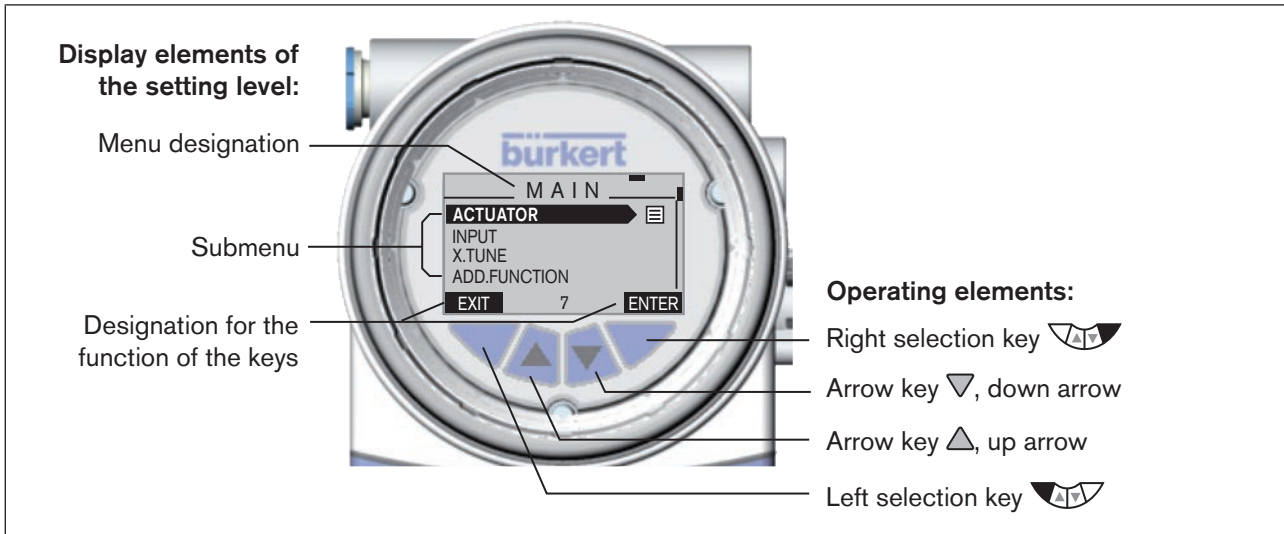


Figure 38: Display and operating elements of the setting level

16.1.1 Description of the symbols which are displayed on the process level

The symbols which are displayed depend on

- type,
- operation as position or process controller,
- AUTOMATIC or MANUAL operating state and
- the activated functions.

Operation	Symbol	Description
Types 8692/8693		AUTOMATIC operating state
Operation as position controller		Diagnosis active (optional; only available if the device has the additional software for the diagnosis)
		X.CONTROL / Position controller active (symbol is indicated for Type 8693 only)
		Save EEPROM (is indicated during the save process)
		CUTOFF active
		SAFEPOS active
		Interface I/O Burst
		Interface I/O RS232 HART
		SECURITY active
Other symbols for Type 8693		P.CONTROL / Process controller active
		Bus active
Operation as process controller		SIMULATION active

Table 19: Symbols of the process level.





16.2 Function of the keys

The functions of the 4 operating keys differ depending on the operating state (AUTOMATIC or MANUAL) and operating level (process level or setting level).

The key function which is active is displayed in the gray text field which is above the key.



The description of the operating levels and operating states can be found in chapter "15 Operating levels" and "17 Operating states".

Key function on the process level:			
Key	Key function	Description of the function	Operating state
Arrow key 	OPN (OPEN)	Manual opening of the actuator.	MANUAL
		Change the displayed value (e.g. POS-CMD-TEMP-...).	AUTOMATIC
Arrow key 	CLS (CLOSE)	Manual closing of the actuator.	MANUAL
		Change the displayed value (e.g. POS-CMD-TEMP-...).	AUTOMATIC
Left selection key 	MENU	Change to the setting level. Note: Press key for approx. 3 s.	AUTOMATIC or MANUAL
Right selection key 	AUTO	Return to AUTOMATIC operating state.	MANUAL
	MANUAL	Change to MANUAL operating state.	AUTOMATIC





Key function on the setting level:		
Key	Key function	Description of the function
Arrow key 		Scroll up in the menus.
	+	Increase numerical values.
Arrow key 		Scroll down in the menus.
	-	Decrease numerical values.
	< -	Change by one digit to the left; when entering numerical values.
Left selection key 	EXIT (BACK)	Return to the process level.
		Gradually return from a submenu option.
	ESC	Leave a menu.
	STOP	Stop a sequence.
Right selection key 	ENTER SELEC OK INPUT	Select, activate or deactivate a menu option.
	EXIT (BACK)	Gradually return from a submenu option.
	RUN	Start a sequence.
	STOP	Stop a sequence.

Table 20: Function of the keys

16.2.1 Entering and changing numerical values

Changing numerical values with fixed decimal places:


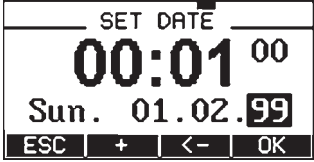






Key	Key function	Description of the function	Example
Arrow key ▾		Change to the next decimal place (from right to left). After reaching the last decimal place, the display switches back to the first decimal place.	Enter date and time. 
Arrow key ▲		Increase value. When the largest possible value has been reached, 0 is displayed again.	
Left selection key 	 or 	Return without change.	
Right selection key 		Accept the set value.	

Table 21: Change numerical values with fixed decimal places.

Enter numerical values with variable decimal places:


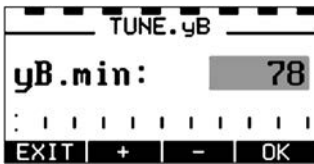






Key	Key function	Description of the function	Example
Arrow key ▲		Increase value.	Enter PWM signal 
Arrow key ▾		Reduce value.	
Left selection key 	 or 	Return without change.	
Right selection key 		Accept the set value.	

Table 22: Enter numerical values with variable decimal places.

16.3 Adjusting the display

The display can be individually adjusted for the operation and monitoring of the process.

- To do this, menu options can be activated for displaying the process level. *POS* and *CMD* are activated in the as-delivered state.
- The menu options which can be displayed depend on the type.



How you can adjust the display for Type 8692 individually to the process to be controlled is described in chapter "25.2.18 EXTRAS – Setting the display", page 143 "

16.3.1 Possible displays of the process level

Possible displays in AUTOMATIC operating state	
	Actual position of the valve actuator (0 ... 100 %)
	<ul style="list-style-type: none"> ▪ Set-point position of the valve actuator or ▪ Set-point position of the valve actuator after rescaling by possibly activated split range function or correction characteristic (0 ... 100 %)
	Internal temperature in the housing of the device (°C)
	Process actual value Only for type 8693
	Process set-point value Right selection key : The key function depends on the set-point value default (menu: P.CONTROL → P.SETUP → SP-INPUT → intern/extern). INPUT Set-point value default = intern MANU Set-point value default = extern Only for type 8693
	Graphical display of <i>SP</i> and <i>PV</i> with time axis Only for type 8693

MAN 1000108626 EN Version: F Status: RL (released | freigegeben) printed: 20.01.2015


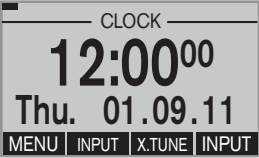
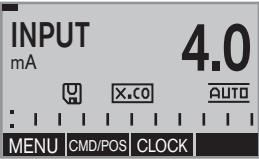
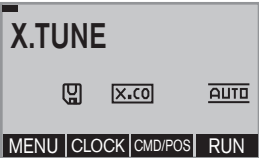
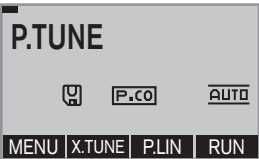

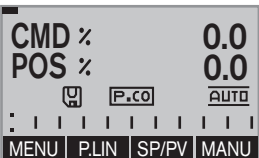
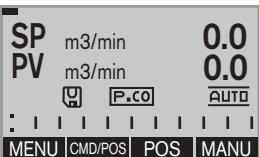
Possible displays in AUTOMATIC operating state	
	Graphical display of <i>POS</i> and <i>CMD</i> with time axis
	Time, weekday and date
	Input signal for set-point position (0 ... 5/10 V or 0/4 ... 20 mA) Only for operation as position controller X.CO
	Automatic adjustment of the position controller
	Automatic optimization of the process controller parameters Only for type 8693
	Automatic linearization of the process characteristics Only for type 8693
	Simultaneous display of the set-point position and the actual position of the valve actuator (0 ... 100 %)
	Simultaneous display of the set-point position and the actual position of the valve actuator (0 ... 100 %) Only for type 8693

Table 23: Displays of the process level in AUTOMATIC operating state

MAN 1000108626 EN Version: F Status: RL (released | freigegeben) printed: 20.01.2015

16.4 Date and time

Date and time are set on the process level in the *CLOCK* menu.

To ensure that the input menu for *CLOCK* can be selected on the process level, the following functions must be activated in 2 stages:

1. The **EXTRAS** auxiliary function in the *ADD.FUNCTION* menu
2. The **CLOCK** function in the *EXTRAS* auxiliary function, *DISP.ITEMS* submenu.

Activating *EXTRAS* and *CLOCK*:











Key	Action	Description
MENU	Press  for approx. 3 s	Switching from process level \Rightarrow setting level.
▲ / ▼	Select <i>ADD.FUNCTION</i>	
ENTER	Press 	The possible auxiliary functions are displayed.
▲ / ▼	Select <i>EXTRAS</i>	
ENTER	Press 	Activate the <i>EXTRAS</i> auxiliary function by marking with a cross ☒ and transfer into the main menu (MAIN).
EXIT	Press 	Return to the main menu (MAIN).
▲ / ▼	Select <i>EXTRAS</i>	
ENTER	Press 	The submenus of <i>EXTRAS</i> are displayed.
▲ / ▼	Select <i>DISP.ITEMS</i>	
ENTER	Press 	The possible menu options are displayed.
▲ / ▼	Select <i>CLOCK</i>	
SELEC	Press 	The activated <i>CLOCK</i> function is now marked by a cross ☒.
EXIT	Press 	Return to the <i>EXTRAS</i> menu.
EXIT	Press 	Return to the main menu (MAIN).
EXIT	Press 	Switching from setting level \Rightarrow process level.



Table 24: *EXTRAS*; Activating the *CLOCK* function



Date and time must be reset whenever the device is restarted.

After a restart the device therefore switches immediately and automatically to the corresponding input menu.

16.4.1 Setting date and time:

→ On the process level select   the display for *CLOCK* using the arrow keys.

→ Press **INPUT** to open the input screen for the setting.

→ Set date and time as described in the following table.



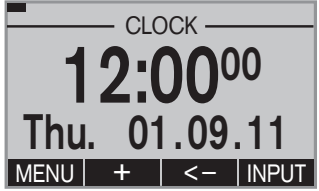








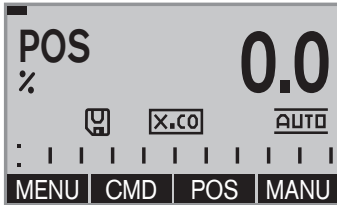
Key	Key function	Description of the function	Input screen
Arrow key 		Switch to the next time unit (from right to left). When the last time unit for the date has been reached, the display switches to the time units for the time. If the last unit is at top left (hours), the display switches back to the first unit at bottom right (year).	
Arrow key 		Increase value. When the largest possible value has been reached, 0 is displayed again.	
Left selection key 		Return without change.	
Right selection key 		Accept the set value.	
 		Switching the display.	

Table 25: Setting date and time

17 OPERATING STATES

Type 8692/8693 has 2 operating states: AUTOMATIC and MANUAL.

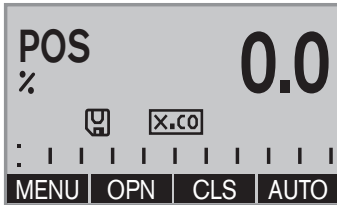
When the operating voltage is switched on, the device is in the AUTOMATIC operating state.



AUTOMATIC

In the AUTOMATIC operating state normal controlled operation is implemented.

(The symbol for AUTOMATIC **AUTO** is shown on the display. (A bar runs along the upper edge of the display).



MANUAL

In the MANUAL operating state the valve can be manually opened or closed via the arrow keys \blacktriangle \blacktriangledown (key function **OPN** and **CLS**).

(The symbol for AUTOMATIC **AUTO** is hidden. (No bar running along the upper edge of the display).

The MANUAL operating state (key function **MANU**) is for the following process value displays only:
POS, CMD, PV, CMD/POS, SPIPV.
 For SP only for external process set-point value.

17.1 Changing the operating state

MANUAL or AUTOMATIC operating state is switched on the process level.

When switching to the setting level, the operating state is retained.

Change to MANUAL operating state	MANU	press	Only available for process value display: <i>POS, CMD, PV, SP</i>
Return to AUTOMATIC operating state	AUTO	press	

18 ACTIVATING AND DEACTIVATING AUXILIARY FUNCTIONS

Auxiliary functions can be activated for demanding control tasks.

! The auxiliary function is activated via the *ADD.FUNCTION* basic function and transferred to the main menu (MAIN).
The auxiliary functions can then be selected and set in the extended main menu (MAIN).

18.1.1 Activating auxiliary functions

Procedure:








Key	Action	Description
MENU	Press  for approx. 3 s	Switching from process level \Rightarrow setting level.
▲ / ▼	Select <i>ADD.FUNCTION</i>	
ENTER	Press 	The possible auxiliary functions are displayed.
▲ / ▼	Select required auxiliary function	
ENTER	Press 	The selected auxiliary function is now marked by a cross ☒.
EXIT	Press 	Acknowledgment and simultaneous return to the main menu (MAIN). The marked function is now activated and incorporated into the main menu.
The parameters can then be set as follows.		
▲ / ▼	Select the auxiliary function	In the main menu (MAIN) select the auxiliary function.
ENTER	Press 	Opening the submenu to input the parameters. The setting of the submenu is described in the respective chapter of the auxiliary function.
Return from the submenu and switch to the process level		
EXIT *	Press 	Return to a higher level or to the main menu (MAIN).
ESC *		
EXIT	Press 	Switching from setting level \Rightarrow process level.
* The designation of the key depends on the selected auxiliary function.		

Table 26: Activating auxiliary functions

MAN 1000108626 EN Version: F Status: RL (released | freigegeben) printed: 20.01.2015

18.1.1.1. Principle: Activating auxiliary functions with simultaneous incorporation into the main menu

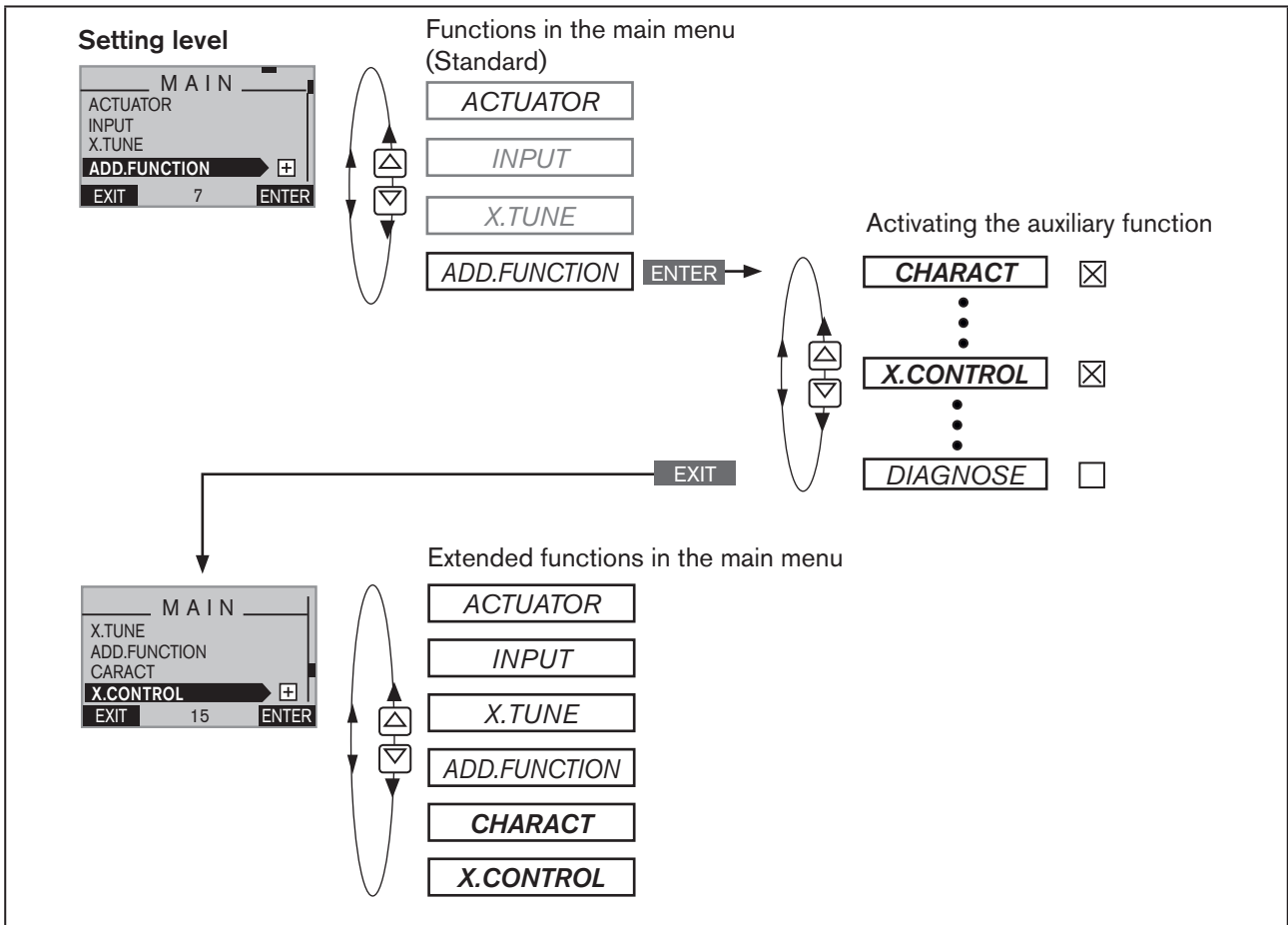


Figure 39: Principle: Activating auxiliary functions with simultaneous incorporation into the main menu (MAIN)

18.1.2 Deactivating auxiliary functions

Procedure:

Key	Action	Description
MENU	Press for approx. 3 s	Switching from process level ⇌ setting level.
▲ / ▼	Select <i>ADD.FUNCTION</i>	
ENTER	Press	The possible auxiliary functions are displayed.
▲ / ▼	Select the auxiliary function	
ENTER	Press	Remove function mark (no cross <input type="checkbox"/>).
EXIT	Press	Acknowledgment and simultaneous return to the main menu (MAIN). The marked function is now deactivated and removed from the main menu.

Table 27: Deactivating auxiliary functions

! Deactivation removes the auxiliary function from the main menu (MAIN). This will cause the previous settings, created under this function, to be rendered invalid.

MAN 1000108626 EN Version: F Status: RL (released | freigegeben) printed: 20.01.2015

19 MANUALLY OPENING AND CLOSING THE VALVE

In the MANUAL operating state, the valve can be opened and closed manually \blacktriangle \blacktriangledown using the arrow keys.



The MANUAL operating state (key function **MANU**) is for the following process value displays:

- *POS*, actual position of the valve actuator.
- *CMD*, set-point position of the valve actuator.
When switching to MANUAL operating state, *POS* is displayed.
- *PV*, process actual value.
- *SP*, process set-point value.
When switching to MANUAL operating state, *PV* is displayed. The switch is possible only for external set-point value default (menu: *P.CONTROL* → *P.SETUP* → *SP-INPUT* → *extern*).
- *CMD/POS*, set-point position of the valve actuator.
When switching to MANUAL operating state, *POS* is displayed.
- *SP/PV*, process set-point value.
When switching to MANUAL operating state, *PV* is displayed. The switch is possible only for external set-point value default (menu: *P.CONTROL* → *P.SETUP* → *SP-INPUT* → *extern*).

Manually opening and closing valve:

Key	Action	Description
\blacktriangle / \blacktriangledown	Select <i>POS</i> , <i>CMD</i> , <i>PV</i> or <i>SP</i>	
MANU	Press	Change to MANUAL operating state
\blacktriangle	press	Aerate the actuator Control function A (SFA): Valve opens Control function B (SFB): Valve closes Control function I (SFI): Connection 2.1 aerated
\blacktriangledown	press	Bleed the actuator Control function A (SFA): Valve closes Control function B (SFB): Valve opens Control function I (SFI): Connection 2.2 aerated

Table 28: Manually opening and closing the valve



- SFA: Actuator spring force closing
- SFB: Actuator spring force opening
- SFI: Actuator double-acting

Start-Up

CONTENTS

20	START-UP SEQUENCE.....	78
21	SAFETY INSTRUCTIONS.....	79
22	BASIC SETTING OF THE DEVICE	79
22.1	ACTUATOR – Enter the operating mode of the valve actuator.....	81
22.2	INPUT - Setting the input signal.....	82
22.3	X.TUNE – Automatic adjustment of the position controller	83
22.3.1	X.TUNE.CONFIG – Manual configuration of X.TUNE	85
23	ACTIVATION OF THE PROCESS CONTROLLER.....	86
24	BASIC SETTING OF THE PROCESS CONTROLLER	87
24.1	P.CONTROL – Setting up and parameterization of the process controller.....	87
24.2	SETUP – Setting up the process controller	89
24.2.1	PV-INPUT – Specifying signal type for the process actual value	89
24.2.2	PV-SCALE – Scaling of the process actual value	90
24.2.3	SP-INPUT – Type of the set-point value default (internal or external).....	94
24.2.4	SP-SCALE – Scaling of the process set-point value (for external set-point value default only).....	94
24.2.5	P.CO-INIT – Smooth switchover MANUAL-AUTOMATIC	96
24.3	PID.PARAMETER – Parameterizing the process controller.....	97
24.3.1	Procedure for inputting the parameters	97
24.3.2	DBND – Insensitivity range (dead band).....	98
24.3.3	KP – Amplification factor of the process controller	98
24.3.4	TN – Reset time of the process controller.....	99
24.3.5	TV – Hold-back time of the process controller.....	99
24.3.6	XO – Operating point of the process controller.....	99
24.3.7	FILTER – Filtering of the process actual value input.....	100
24.4	P.Q'LIN – Linearization of the process characteristic.....	101
24.5	P.TUNE – Self-optimization of the process controller	102
24.5.1	The mode of operation of P.TUNE	102
24.5.2	Preparatory measure for execution of P.TUNE	102
24.5.3	Starting the function P.TUNE	104

20 START-UP SEQUENCE



Before start-up, carry out pneumatic, fluid and electrical installation of Type 8692/8693 and of the valve. For a description see chapters “12” und “13”.

When the operating voltage is applied, Type 8692/8693 is operating and is in the AUTOMATIC operating state. The display shows the process level with the values for *POS* and *CMD*.

The following basic settings must be made for starting up the device:

Device type	Sequence	Type of basic setting	Setting via	Description in chapter	Requirement
8692 and 8693	1	Basic setting of the device: Enter the operating mode of the valve actuator. ⚠ Generally not required for the initial start-up! The operating mode of the actuator has been preset in the factory.	<i>ACTUATOR</i>	“22.1”	essential
	2	Set input signal (standard signal).	<i>INPUT</i>	“22.2”	
	3	Adjust device to the local conditions.	<i>X.TUNE</i>	“22.3”	
only 8693 (Process controller)	4	Activate process controller.	<i>ADD.FUNCTION</i>	“23”	essential
	5	Basic setting of the process controller: – Setting the hardware	<i>P.CONTROL</i>	“24”	
			→ <i>SETUP</i>	“24.2”	
	6	– Parameter setting of the software.	→ <i>PID.PARAMETER</i>	“24.3”	
7	Automatic linearization of the process characteristics.	<i>P.Q'LIN</i>	“24.4”	to be implemented optionally	
8	Automatic parameter setting for the process controller.	<i>P.TUNE</i>	“24.5”		

Table 29: Start-up sequence

The basic settings are made on the setting level.

To switch from the process to the setting level, press the **MENU** key for approx. 3 seconds.

Then the main menu (MAIN) of the setting level is indicated on the display.

21 SAFETY INSTRUCTIONS



WARNING!

Risk of injury from improper operation!

Improper operation may result in injuries as well as damage to the device and the area around it

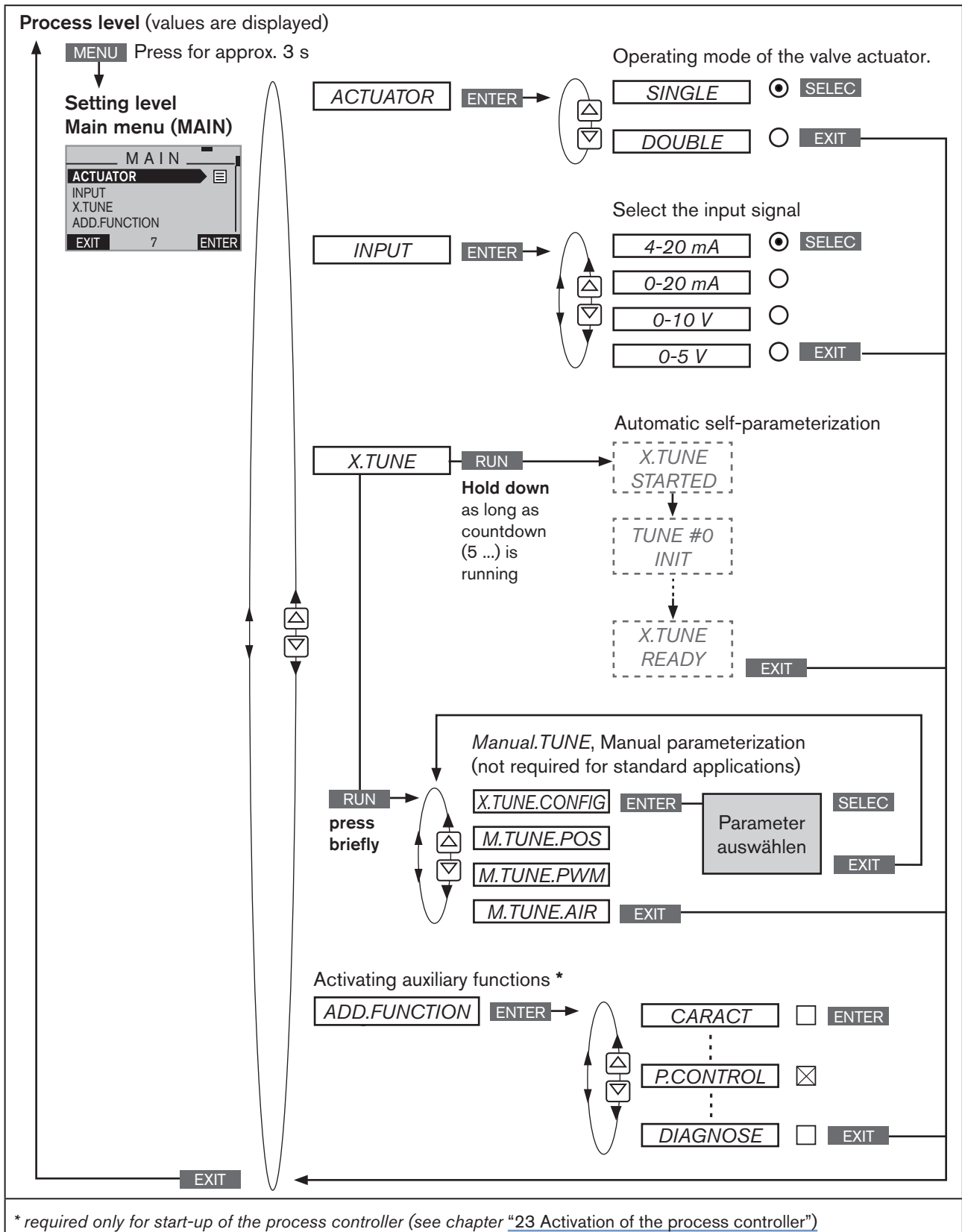
- ▶ Before start-up, ensure that the operating personnel are familiar with and completely understand the contents of the operating instructions.
- ▶ Observe the safety instructions and intended use.
- ▶ Only adequately trained personnel may start up the equipment/the device.

22 BASIC SETTING OF THE DEVICE

The following settings must be made for the basic setting of Type 8692/8693:

1. ACTUATOR Enter the operating mode of the valve actuator. (see chapter [“22.1”](#))
 - ⓘ Generally not required for the initial start-up!
The operating mode of the actuator has been preset in the factory.
2. INPUT Selection of the input signal (see chapter [“22.2”](#)).
3. X.TUNE Automatic self-parameterization of the position controller (see chapter [“22.3”](#))

Operating structure for the basic setting:



MAN 1000108626 EN Version: F Status: RL (released | freigegeben) printed: 20.01.2015

Figure 40: MAIN – main menu, operating structure in as-delivered state

22.1 ACTUATOR – Enter the operating mode of the valve actuator

The operating mode of the pneumatic valve actuator used in combination with the Type 8692/8693 can be input in this menu option.

! Generally not required for the initial start-up!
The operating mode of the valve actuator has been preset in the factory.

Procedure:

Key	Action	Description
MENU	Press for approx. 3 s	Switching from process level \Rightarrow setting level.
▲ / ▼	Select ACTUATOR	
ENTER	Press	The possible operating modes for the valve actuator are displayed.
▲ / ▼	Select operating mode (SINGLE, DOUBLE)	
SELEC	Press	The selected operating mode is now marked by a filled circle .
EXIT	Press	Return to the main menu (MAIN).
EXIT	Press	Switching from setting level \Rightarrow process level.

Table 30: Enter the operating mode of the valve actuator

The operating mode of the valve actuator depends on the control function of the valve. This is indicated on the rating plate.

Control function of the valve	Identification on the rating plate	Operating mode of the valve actuator
A or B	SFA or SFB	single-acting (SINGLE)
I	SFI	double-acting (DOUBLE)

Table 31: Operating mode of the valve actuator

Operating structure:

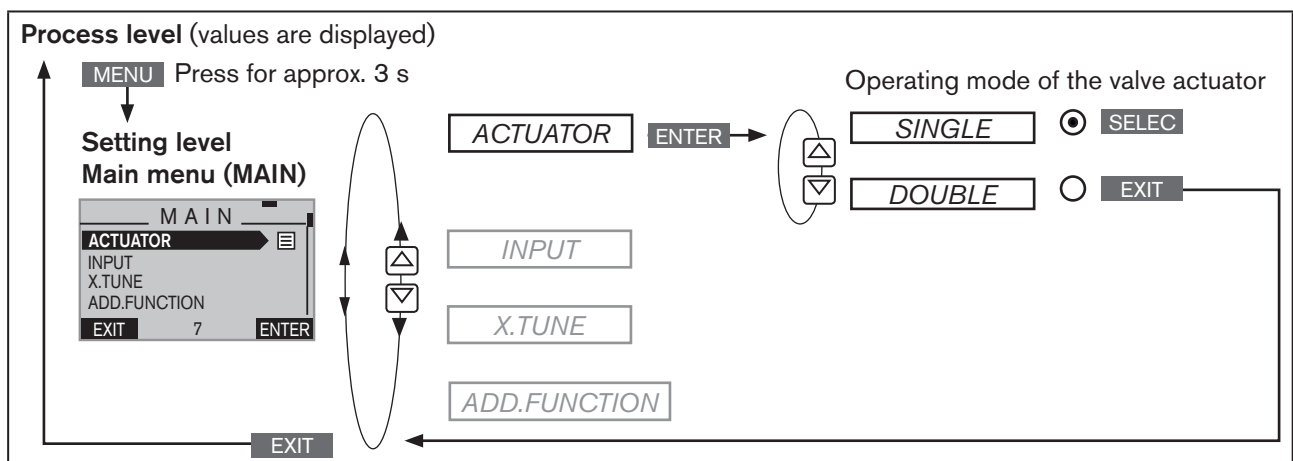


Figure 41: Operating structure of ACTUATOR

MAN 1000108626 EN Version: F Status: RL (released | freigegeben) printed: 20.01.2015

22.2 INPUT - Setting the input signal

This setting is used to select the input signal for the set-point value.

Procedure:







Key	Action	Description
MENU	Press  for approx. 3 s	Switching from process level \Rightarrow setting level.
▲ / ▼	Select <i>INPUT</i>	
ENTER	Press 	The possible input signals for <i>INPUT</i> are displayed.
▲ / ▼	Select input signal (4-20 mA, 0-20 mA,...)	
SELEC	Press 	The selected input signal is now marked by a filled circle  .
EXIT	Press 	Return to the main menu (MAIN).
EXIT	Press 	Switching from setting level \Rightarrow process level.

Table 32: Setting the input signal

Operating structure:

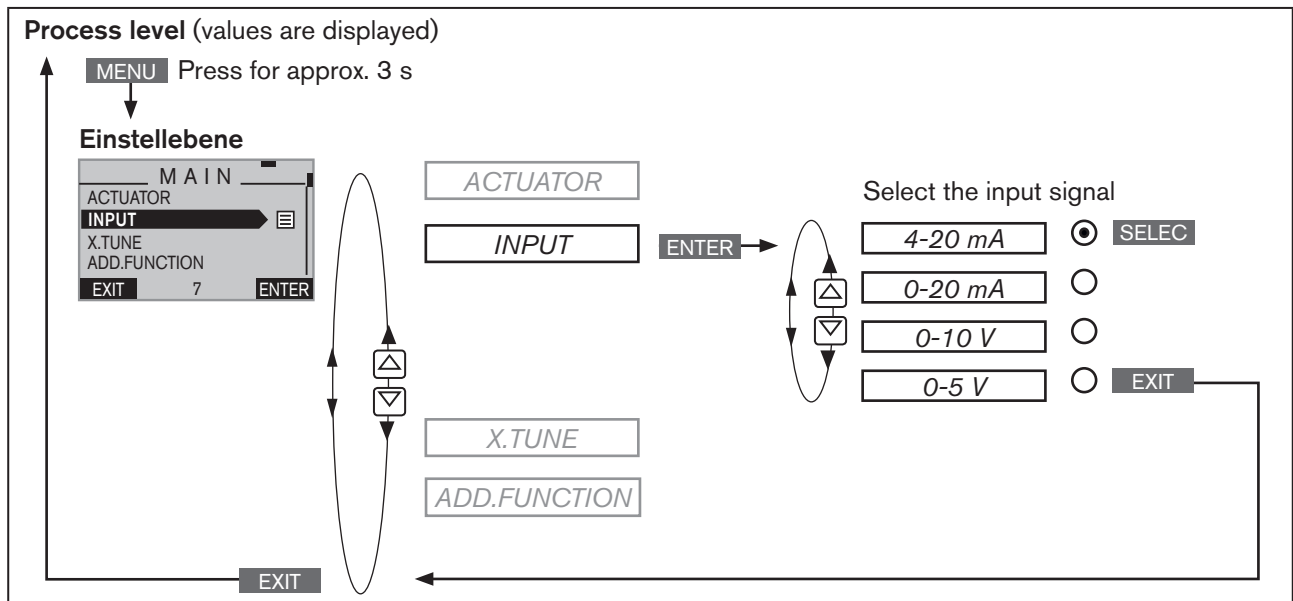


Figure 42: Operating structure INPUT

22.3 X.TUNE – Automatic adjustment of the position controller

WARNING!

Danger due to the valve position changing when the X.TUNE function is run!

When the X.TUNE function is run under operating pressure, there is an acute risk of injury.

- ▶ Never run X.TUNE while the process is running!
- ▶ Secure system against unintentional activation!

NOTE!

An incorrect supply pressure or incorrectly connected operating medium pressure may cause the controller to be wrongly adjusted!

- ▶ Run X.TUNE in each case at the supply pressure available in subsequent operation (= pneumatic auxiliary power).
- Run the X.TUNE function preferably **without** operating medium pressure to exclude interference due to flow forces.

The following functions are actuated automatically:

- Adjustment of the sensor signal to the (physical) stroke of the actuator used.
- Determination of parameters of the PWM signals to control the solenoid valves integrated in type 8692/8693.
- Adjustment of the controller parameters for the position controller. Optimization occurs according to the criteria of the shortest possible transient time without overshoots.

Procedure:





Key	Action	Description
MENU	Press  for approx. 3 s	Switching from process level \Rightarrow setting level.
	Select X.TUNE	
RUN	 Hold down as long as countdown (5 ...) is running	While the automatic adjustment is running, messages on the progress of the X.TUNE (e.g. "TUNE #1...") are indicated on the display. <i>When the automatic adjustment ends, the message "X.TUNE READY" is indicated.</i>
	Press any key	Return to the main menu (MAIN).
EXIT	Press 	Switching from setting level \Rightarrow process level.

Table 33: Automatic adjustment of X.TUNE



To stop X.TUNE, press the left or right selection key **STOP**.

Operating structure:

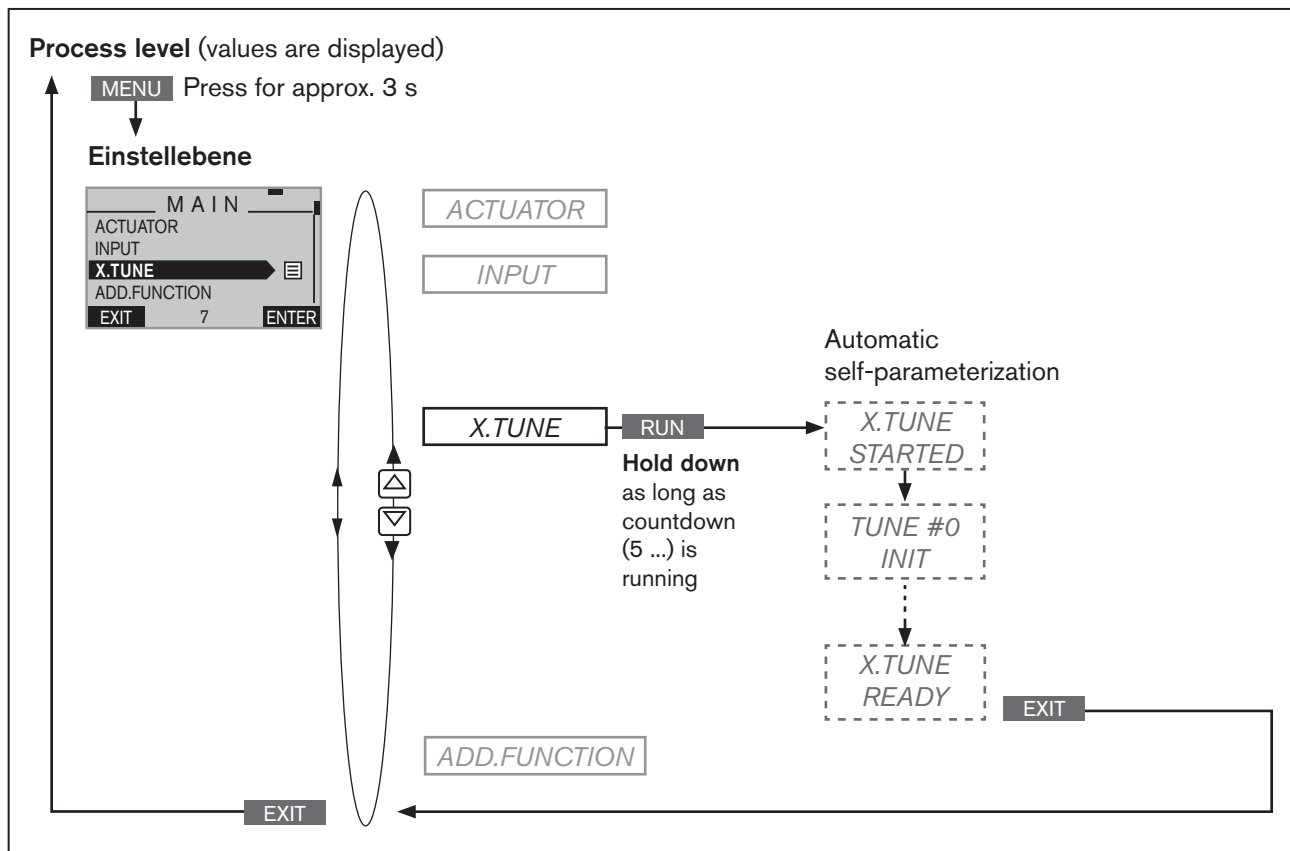



Figure 43: Operating structure X.TUNE

Automatically determining dead band DBND by running X.TUNE:

! When X.TUNE is running, the dead band can be automatically determined depending on the friction behavior of the actuating drive.
 Before running X.TUNE, the X.CONTROL auxiliary function must be activated by incorporating it into the main menu (MAIN).
 If X.CONTROL is not activated, a fixed dead band of 1 % is used.

! The changed data is saved in the memory (EEPROM) only when there is a switch to the process level, by leaving the main menu (MAIN) using the left selection key **EXIT**. During the save process, the save symbol is indicated  on the display.

Possible error messages when running X.TUNE:

Display	Causes of error	Remedial action
TUNE err/break	Manual termination of self-parameterization by pressing the EXIT key	
X.TUNE locked	The X.TUNE function is blocked	Input access code
X.TUNE ERROR 1	No compressed air connected	Connect compressed air

MAN 1000108626 EN Version: F Status: RL (released | freigegeben) printed: 20.01.2015

<i>X.TUNE ERROR 2</i>	Compressed air failed during Autotune (<i>X.TUNE</i>).	Check compressed air supply
<i>X.TUNE ERROR 3</i>	Actuator or control system deaeration side leaking	Not possible, device defective
<i>X.TUNE ERROR 4</i>	Control system aeration side leaking	Not possible, device defective
<i>X.TUNE ERROR 6</i>	The end positions for <i>POS-MIN</i> and <i>POS-MAX</i> are too close together	Check compressed air supply
<i>X.TUNE ERROR 7</i>	Incorrect assignment <i>POS-MIN</i> and <i>POS-MAX</i>	To determine <i>POS-MIN</i> and <i>POS-MAX</i> , move the actuator in the direction indicated on the display.

Table 34: *X.TUNE*; possible error messages

After making the settings described in chapters [“22.2”](#) and [“22.3”](#), the positioner (position controller) is ready for use.

Activation and configuration of auxiliary functions is described in the following chapter [“25 Configuring the auxiliary functions”](#).

22.3.1 *X.TUNE.CONFIG* – Manual configuration of *X.TUNE*

This function is needed for special requirements only.



For standard applications the *X.TUNE* function (automatic adjustment of the positioner), as described above, is run using the factory default settings.

The description of the *X.TUNE.CONFIG* function can be found in chapter [“25.3 Manual configuration of *X.TUNE*”](#).

23 ACTIVATION OF THE PROCESS CONTROLLER

The process controller is activated by selecting the *P.CONTROL* auxiliary function in the *ADD.FUNCTION* menu. The activation transfers *P.CONTROL* into the main menu (MAIN) where it is available for further settings.

Procedure:





Key	Action	Description
MENU	Press  for approx. 3 s	Switching from process level ⇔ setting level.
▲ / ▼	Select <i>ADD.FUNCTION</i>	
ENTER	Press 	The possible auxiliary functions are displayed.
▲ / ▼	Select <i>P.CONTROL</i>	
ENTER	Press 	<i>P.CONTROL</i> is now marked by a cross ☒.
EXIT	Press 	Acknowledgment and simultaneous return to the main menu (MAIN). <i>P.CONTROL</i> is now activated and incorporated into the main menu.

Table 35: Activating auxiliary functions



Following activation of *P.CONTROL*, the *P.Q'LIN* and *P.TUNE* menus are also available in the main menu (MAIN). They offer support for the setting of the process control.

P.Q'LIN Linearization of the process characteristic
Description see chapter [“24.4”](#)

P.TUNE Self-optimization of the process controller (process tune)
Description see chapter [“24.5”](#)

ADD.FUNCTION – Add auxiliary functions

Apart from activating the process controller, *ADD.FUNCTION* can be used to activate auxiliary functions and incorporate them into the main menu.

The description can be found in chapter [“25 Configuring the auxiliary functions”](#).

24 BASIC SETTING OF THE PROCESS CONTROLLER

24.1 P.CONTROL – Setting up and parameterization of the process controller

To start up the process controller, you must make the following settings in the *P.CONTROL* menu:

1. **SETUP** Set up the process controller (configuration)
2. **PID.PARAMETER** Parameterize process controller

Operating structure:

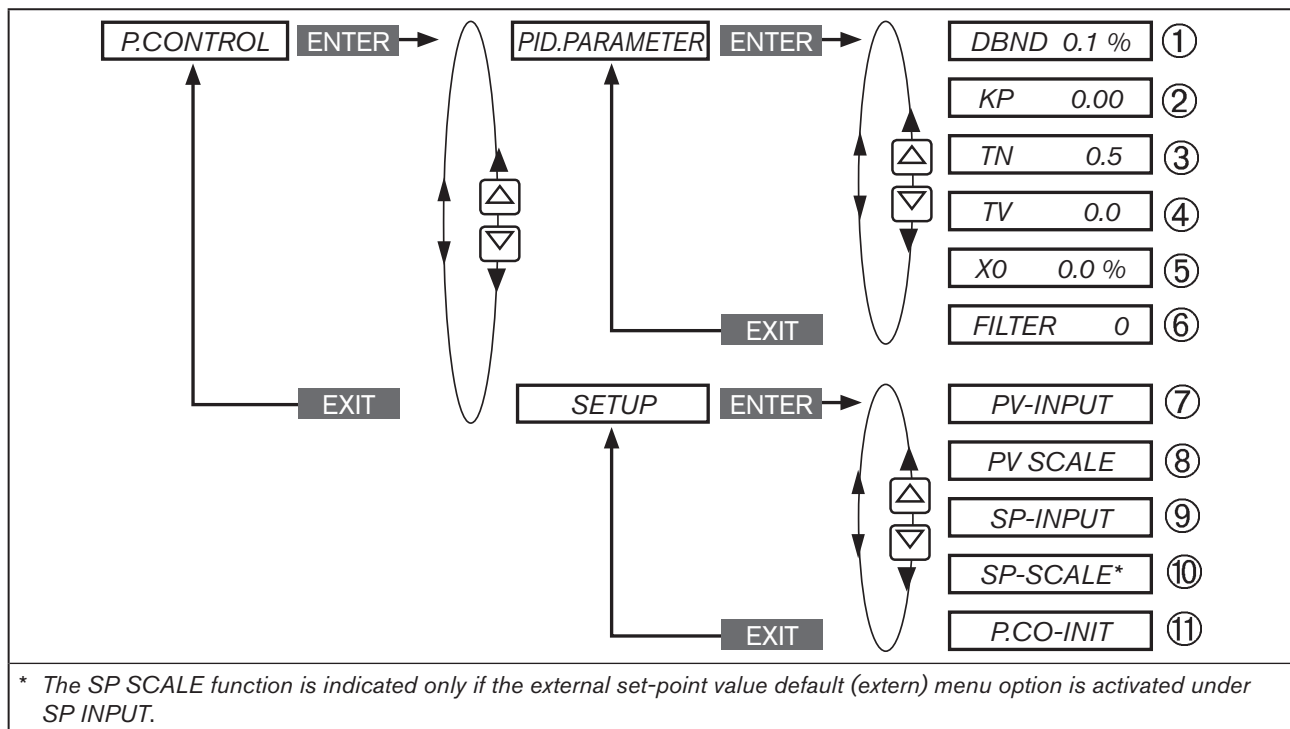


Figure 44: Operating structure P.CONTROL

Key:

- ① Insensitivity range (dead band) of the PID process controller
- ② Amplification factor of the process controller
- ③ Reset time
- ④ Hold-back time
- ⑤ Operating point
- ⑥ Filtering of the process actual value input
- ⑦ Indication of the signal type for process actual value (4 - 20 mA, frequency input, Pt 100 input)
- ⑧ Specification of the physical unit and scaling of the process actual value
- ⑨ Type of set-point value default (internal or external)
- ⑩ Scaling of the process set-point value (only for external set-point value default)
- ⑪ Enables a smooth switchover between AUTOMATIC and MANUAL mode

Procedure:









Key	Action	Description
MENU	Press  for approx. 3 s	Switching from process level ⇔ setting level.
▲ / ▼	Select <i>P.CONTROL</i>	Selection in the main menu (MAIN).
ENTER	Press 	The submenu options for basic settings can now be selected.
1. Set up process controller (configuration)		
▲ / ▼	Select <i>SETUP</i>	
ENTER	Press 	The menu for setting up the process controller is displayed. Set up is described in chapter “24.2 SETUP – Setting up the process controller” .
EXIT	Press 	Return to <i>P.CONTROL</i> .
2. Parameterize process controller		
▲ / ▼	Select <i>PID.PARAMETER</i>	
ENTER	Press 	The menu for parameterizing the process controller is displayed. Parameterization is described in chapter “24.3 PID.PARAMETER – Parameterizing the process controller” .
EXIT	Press 	Return to <i>P.CONTROL</i> .
EXIT	Press 	Return to the main menu (MAIN).
EXIT	Press 	Switching from setting level ⇔ process level.

Table 36: *P.CONTROL*; basic settings of the process controller

24.2 SETUP – Setting up the process controller

These functions specify the type of control.

The procedure is described in the following chapters “24.2.1” to “24.2.5”.

24.2.1 PV-INPUT – Specifying signal type for the process actual value

One of the following signal types can be selected for the process actual value:

- Standard signal 4 ... 20 mA flow rate, pressure, level
- Frequency signal 0 ... 1000 Hz flow rate
- Circuit with Pt 100 -20 °C ... +220 °C temperature

Factory setting: 4 ... 20 mA

Operating structure:

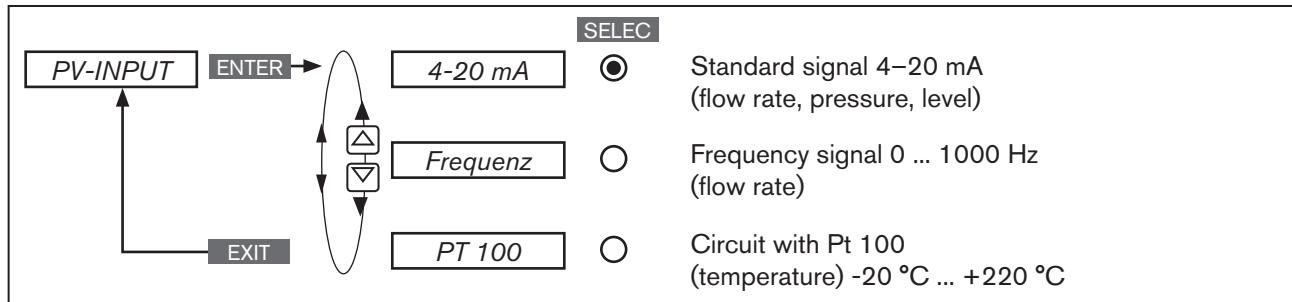


Figure 45: Operating structure PV-INPUT

Specifying signal type in the menu SETUP → PV-INPUT:

Key	Action	Description
▲ / ▼	Select PV-INPUT	
ENTER	Press	The signal types are displayed.
▲ / ▼	Select signal type	
SELEC	Press	The selected signal type is now marked by a filled circle ●.
EXIT	Press	Return to SETUP.

Table 37: PV-INPUT; specifying signal type

24.2.2 PV-SCALE – Scaling of the process actual value

The following settings are specified in the submenu of PV-SCALE:

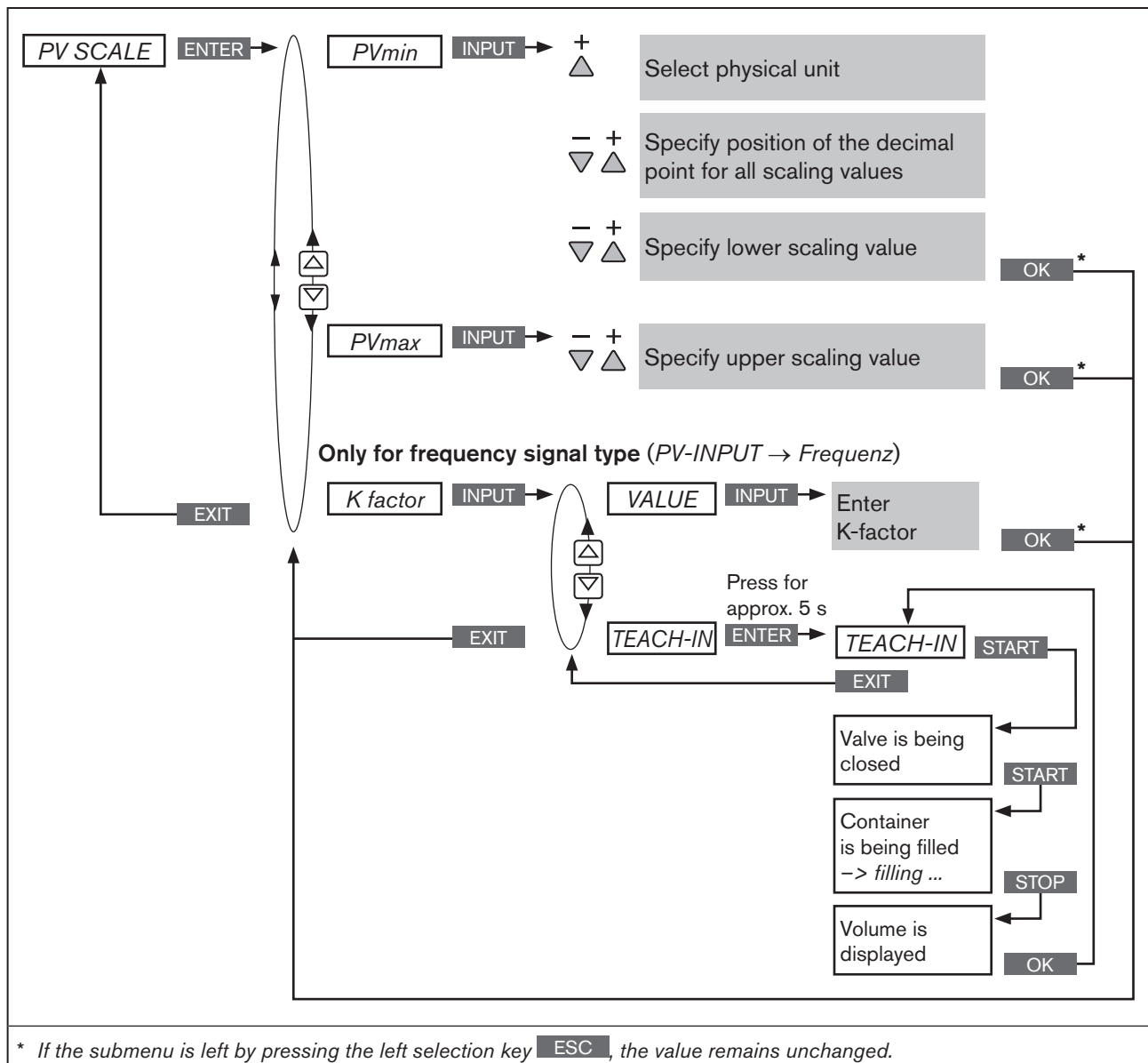
- PVmin**
 1. The physical unit of the process actual value.
 2. Position of the decimal point of the process actual value.
 3. Lower scaling value of the process actual value.

! In *PVmin* the unit of the process actual value and the position of the decimal point are specified for all scaling values (*SPmin*, *SPmax*, *PVmin*, *PVmax*).

PVmax Upper scaling value of the process actual value.

K factor K-factor for the flow sensor
The menu option is available only for the frequency signal type (*PV-INPUT* → *Frequenz*).

Operating structure:



MAN 1000108626 EN Version: F Status: RL (released | freigegeben) printed: 20.01.2015

Figure 46: Operating structure PV-SCALE

24.2.2.1. Effects and dependencies of the settings of PV-INPUT on PV-SCALE

The settings in the PV-SCALE menu have different effects, depending on the signal type selected in PV-INPUT.



Even the selection options for the units of the process actual value (in PVmin) depend on the signal type selected in PV-INPUT.

See following "Table 38"

Settings in the submenu of PV-SCALE	Description of the effect	Dependency on the signal type selected in PV-INPUT		
		4 - 20 mA	PT 100	Frequenz
PVmin	Selectable unit of the process actual value for the physical variables.	Flow rate, temperature, pressure, length, volume. (as well as ratio as % and no unit)	Temperature	Flow-rate
	Adjustment range:	0 ... 9999 (Temperature -200 ... 800)	-200 ... 800	0 ... 9999
PVmin PVmax	Specification of the reference range for the dead band of the process controller (P.CONTROL → PID.PARAMETER → DBND).	Yes	Yes	Yes
	Specification of the reference range for the analog feedback (option). See chapter "25.2.14.1. OUT ANALOG - Configuring the analogue output".	Yes	Yes	Yes
	Sensor calibration:	Yes see "Figure 47"	No	No
K factor	Sensor calibration:	No	No	Yes see "Figure 48"
	Adjustment range:	-	-	0 ... 9999

Table 38: Effects of the settings in PV-SCALE depending on the signal type selected in PV-INPUT

Example of a sensor calibration for signal type 4 - 20 mA:

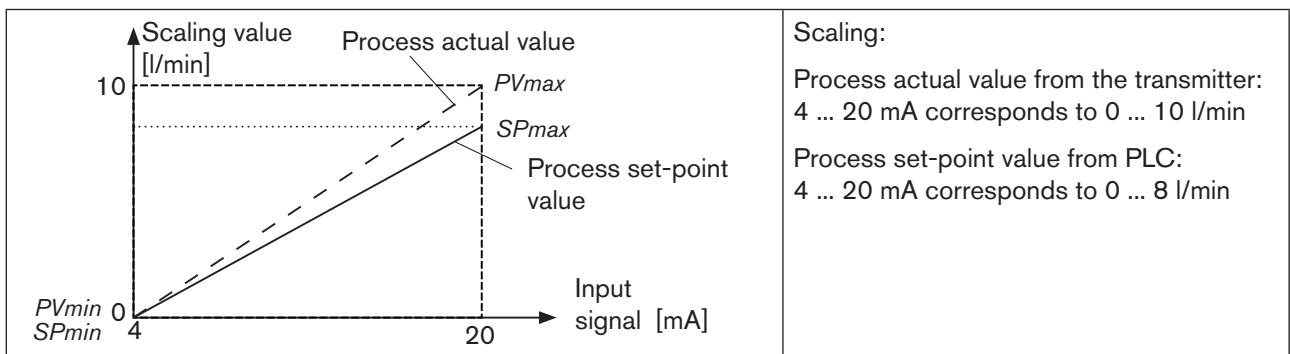


Figure 47: Example of a sensor calibration for signal type 4 - 20 mA

! For internal set-point value default (*SP-INPUT* → *intern*), the process set-point value is input directly on the process level.

Example of a sensor calibration for frequency (*Frequenz*) signal type:



Figure 48: Example of a sensor calibration for frequency (*Frequenz*) signal type

Scaling of the process actual value in the menu *SETUP* → *PV-SCALE*:

Key	Action	Description
▲ / ▼	Select <i>PV-SCALE</i>	Selection in the main menu (MAIN).
ENTER	Press	The submenu options for scaling of the process actual value are displayed.
1. Setting <i>PVmin</i>		
▲ / ▼	Select <i>PVmin</i>	
INPUT	Press	The input screen is opened. First specify the physical unit which has a dark background.
▲	Press + (x times)	Select physical unit.
▼	<- Select decimal point	The decimal point has a dark background.
▲	Press + (x times)	Specify position of the decimal point.
▼	<- Select scaling value	The last digit of the scaling value has a dark background.
▲ / ▼	+ Increase value <- Select decimal place	Set scaling value (lower process actual value).
OK	Press	Return to <i>PV-SCALE</i> .
2. Setting <i>PVmax</i>		
▲ / ▼	Select <i>PVmax</i>	
INPUT	Press	The input screen is opened. The last digit of the scaling value has a dark background.
▲ / ▼	+ Increase value <- Select decimal place	Set scaling value (upper process actual value).
OK	Press	Return to <i>PV-SCALE</i> .



















Key	Action	Description
3. Setting <i>K-factor</i> (only available for frequency signal type)		
▲ / ▼	Select <i>K-factor</i>	
ENTER	Press 	The submenu for the setting of the K-factor is displayed.
either		
▲ / ▼	Select <i>VALUE</i>	Manual input of the K-factor.
INPUT	Press 	The input screen is opened. The decimal point has a dark background.
▲	 Select decimal point	Specify position of the decimal point.
▼	 Select value	The last digit of the value has a dark background.
▲ / ▼	 Select decimal place  Increase value	Set K-factor.
OK	Press 	Return to <i>K-factor</i> .
or		
▲ / ▼	Select <i>TEACH-IN</i>	Calculating the K-factor by measuring a specific flow rate.
ENTER	Press  for approx. 5 s	The valve is being closed.
START	Press 	The container is being filled.
STOP	Press 	The measured volume is displayed and the input screen is opened. The decimal point has a dark background.
▲	 Select decimal point	Specify position of the decimal point.
▼	 Select value	The last digit of the value has a dark background.
▲ / ▼	 Select decimal place  Increase value	Set the measured volume.
OK	Press 	Return to <i>TEACH-IN</i> .
EXIT	Press 	Return to <i>K-factor</i> .
EXIT	Press 	Return to <i>PV-SCALE</i> .
EXIT	Press 	Return to <i>SETUP</i> .

Table 39: *PV-SCALE; scaling process actual value*

If the submenu is left by pressing the left selection key **ESC**, the value remains unchanged.

24.2.3 SP-INPUT – Type of the set-point value default (internal or external)

The SP-INPUT menu specifies how the default of the process set-point value is to be implemented.

- Internal: Input of the set-point value on the process level
- External: Default of the set-point value via the standard signal input

Operating structure:

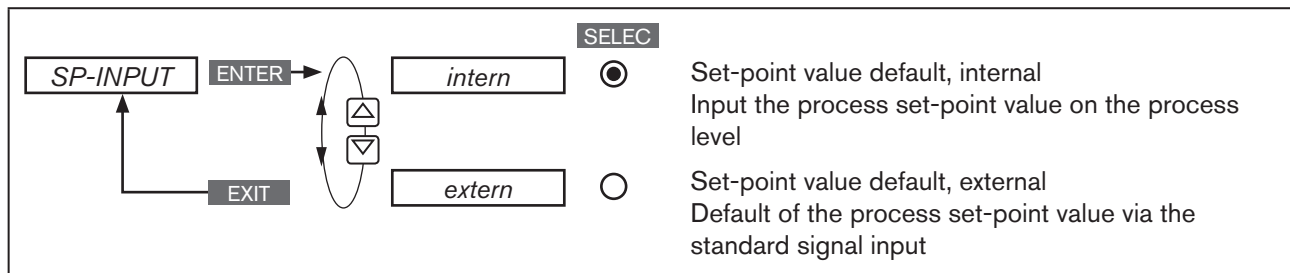


Figure 49: Operating structure PV-INPUT

Specify type of set-point value default in the menu **SETUP** → **SP-INPUT**:

Key	Action	Description
▲ / ▼	Select SP-INPUT	
ENTER	Press	The types of set-point value default are displayed.
▲ / ▼	Select the type of set-point value default	
SELEC	Press	The selection is marked by a filled circle ●.
EXIT	Press	Return to SETUP .

Table 40: SP-INPUT; specifying type of the set-point value default

! For internal set-point value default (**SP-INPUT** → **intern**), the process set-point value is input directly on the process level.

24.2.4 SP-SCALE – Scaling of the process set-point value (for external set-point value default only)

The **SP-SCALE** menu assigns the values for the lower and upper process set-point value to the particular current or voltage value of the standard signal.

The menu is available for external set-point value default only (**SP-INPUT** → **extern**).

! For internal set-point value default (**SP-INPUT** → **intern**), there is no scaling of the process set-point value via **SPmin** and **SPmax**.

The set-point value is input directly on the process level. The physical unit and the position of the decimal point are specified during the scaling of the process actual value (**PV-SCALE** → **PVmin**).

For description see chapter [“24.2.2 PV-SCALE – Scaling of the process actual value”](#), page 90

Operating structure:

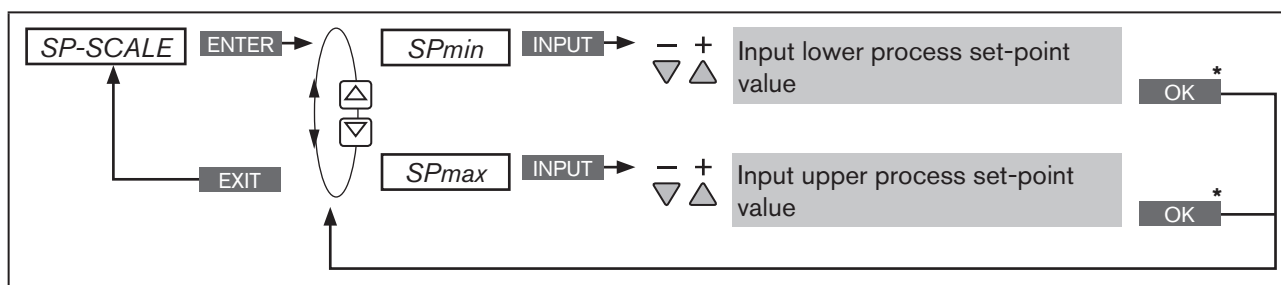


Figure 50: Operating structure SP-SCALE

Scaling process set-point value **SETUP** → **SP-SCALE**:

Key	Action	Description
▲ / ▼	Select SP-SCALE	
ENTER	Press	The submenu options for scaling of the process set-point value are displayed.
▲ / ▼	Select SPmin	
INPUT	Press	The input screen is opened.
▲ / ▼	+ Increase value <- Select decimal place	Set scaling value (lower process set-point value). The value is assigned to the smallest current or voltage value of the standard signal.
OK	Press	Return to SP-SCALE .
▲ / ▼	Select SPmax	
INPUT	Press	The input screen is opened.
▲ / ▼	+ Increase value <- Select decimal place	Set scaling value (upper process set-point value). The value is assigned to the largest current or voltage value of the standard signal.
OK	Press	Return to SP-SCALE .
EXIT	Press	Return to SETUP .

Table 41: SP-SCALE; scaling process set-point value

If the submenu is left by pressing the left selection key **ESC**, the value remains unchanged.

MAN 1000108626 EN Version: F Status: RL (released | freigegeben) printed: 20.01.2015

24.2.5 P.CO-INIT – Smooth switchover MANUAL-AUTOMATIC

The smooth switchover between the MANUAL and AUTOMATIC states can be activated or deactivated in the P.CO-INIT menu.

Factory default setting: bumpless Smooth switchover activated.

Operating structure:

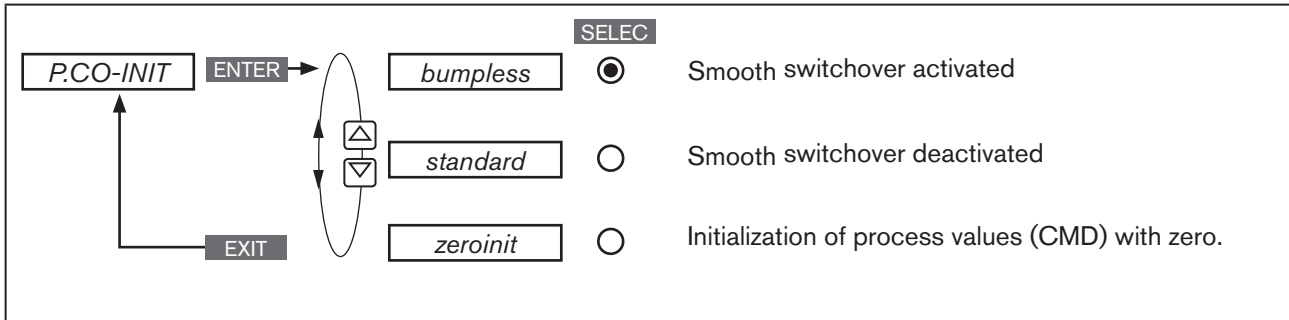


Figure 51: Operating structure P.CO-INIT

Procedure:

Key	Action	Description
▲ / ▼	Select P.CO-INIT	
ENTER	Press	The selection (<i>bumpless</i>) and (<i>standard</i>) is displayed.
▲ / ▼	Select required function	<i>bumpless</i> = smooth switchover activated <i>standard</i> = smooth switchover deactivated
SELEC	Press	The selection is marked by a filled circle ●.
EXIT	Press	Return to SETUP.

Table 42: P.CO-INIT; smooth switchover MANUAL-AUTOMATIC

24.3 PID.PARAMETER – Parameterizing the process controller

The following control parameters of the process controller are manually set in this menu.

DBND 1.0 %	Insensitivity range (dead band) of the process controller
KP 1.00	Amplification factor of the (P-contribution of the PID controller)
TN 999.0	Reset time (I-contribution of the PID controller)
TV 0.0	Hold-back time (D-contribution of the PID controller)
X0 0.0 %	Operating point
FILTER 0	Filtering of the process actual value input



The automatic parameterization of the PID controller integrated in the process controller (menu options *KP*, *TN*, *TV*) can be implemented with the aid of the *P.TUNE* function (see chapter “24.5 P.TUNE – Self-optimization of the process controller”).



Basic information for setting the process controller can be found in chapters “39 Properties of PID Controllers” and “40 Adjustment rules for PID Controllers”.

24.3.1 Procedure for inputting the parameters

The settings in the *PID.PARAMETER* menu are always made in the same way.

Procedure:

Key	Action	Description
▲ / ▼	Select <i>PID.PARAMETER</i>	
ENTER	Press	The menu for parameterizing the process controller is displayed.
▲ / ▼	Select menu option	
INPUT	Press	The input screen is opened.
▲ / ▼	+ Increase value - Reduce value or <- Select decimal place + Increase value	Set value when * DBND X.X % / X0 0 % / FILTER 5 : Set value when * KP X.XX / TN X.0 sec / TV 1.0 sec :
OK	Press	Return to <i>PID.PARAMETER</i> .
EXIT	Press	Return to <i>P.CONTROL</i> .
EXIT	Press	Return to the main menu (MAIN).
EXIT	Press	Switching from setting level ⇌ process level.

* The description of the submenus of *PID.PARAMETER* can be found in the following chapters.

Table 43: *PID.PARAMETER*; parameterizing process controller



If the submenu is left by pressing the left selection key **ESC**, the value remains unchanged.

24.3.2 DBND – Insensitivity range (dead band)

This function causes the process controller to respond from a specific control difference only. This protects both the solenoid valves in Type 8692/8693 and the pneumatic actuator.

Factory setting: 1.0 % with reference to the range of the scaled process actual value (setting in the menu *PV-SCALE* → *PVmin* → *PVmax*).

Operating structure:

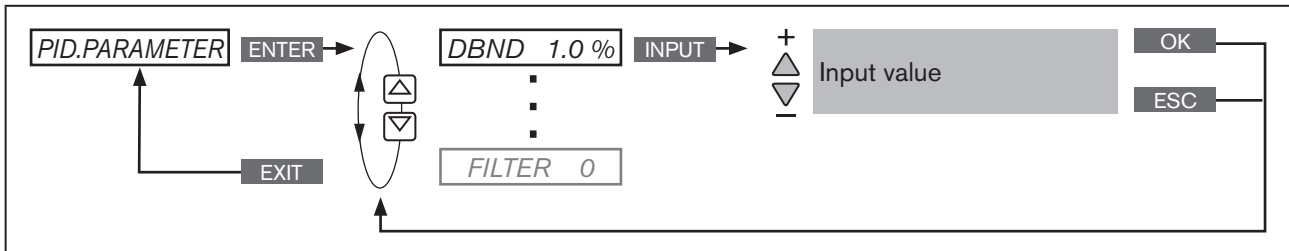


Figure 52: Operating structure DBND; insensitivity range

Insensitivity range for process control

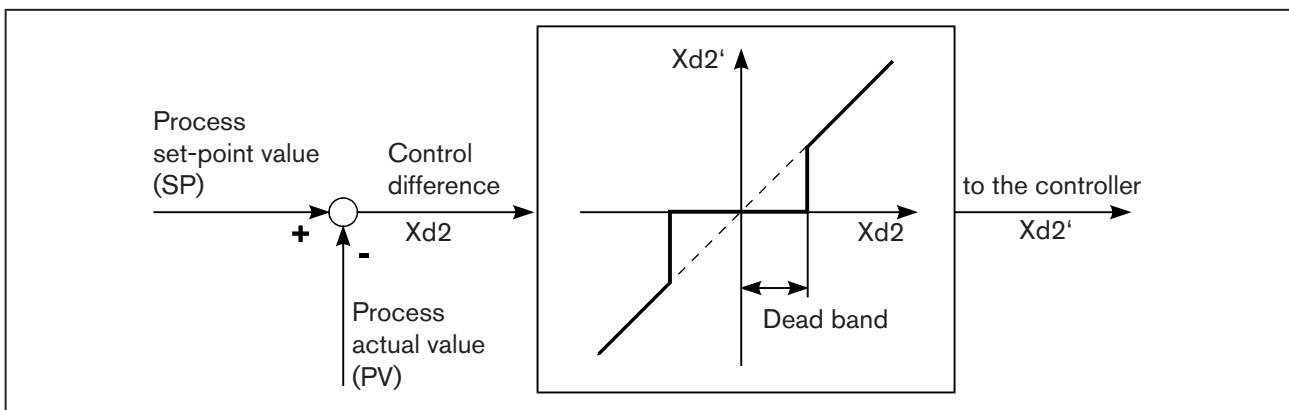


Figure 53: Diagram DBND; insensitivity range for process control

24.3.3 KP – Amplification factor of the process controller

The amplification factor specifies the P-contribution of the PID controller (can be set with the aid of the *P.TUNE* function).

Factory setting: 1.00

Operating structure:

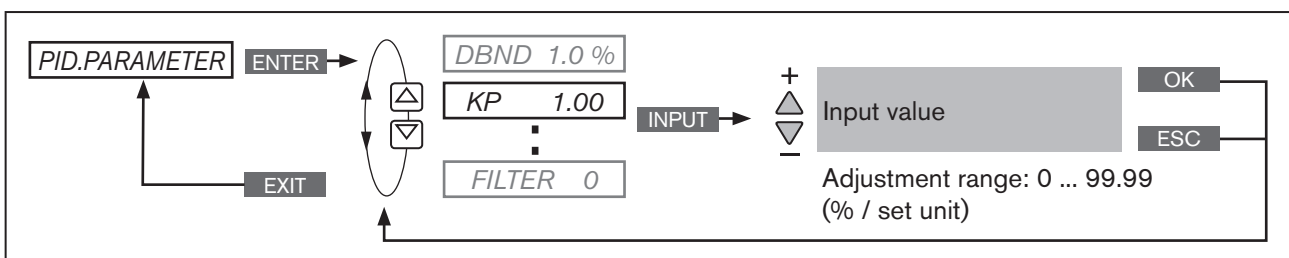


Figure 54: Operating structure KP; amplification factor

! The *KP* amplification of the process controller refers to the scaled, physical unit.

24.3.4 TN – Reset time of the process controller

The reset time specifies the I-contribution of the PID controller (can be set with the aid of the *P.TUNE* function).

Factory setting: 999.9 s

Operating structure:

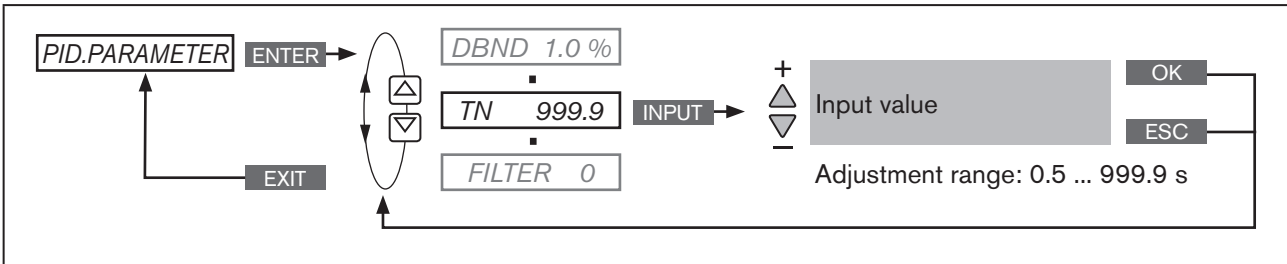


Figure 55: Operating structure TN; reset time

24.3.5 TV – Hold-back time of the process controller

The hold-back time specifies the D-contribution of the PID controller (can be set with the aid of the *P.TUNE* function).

Factory setting: 0.0 s

Operating structure:

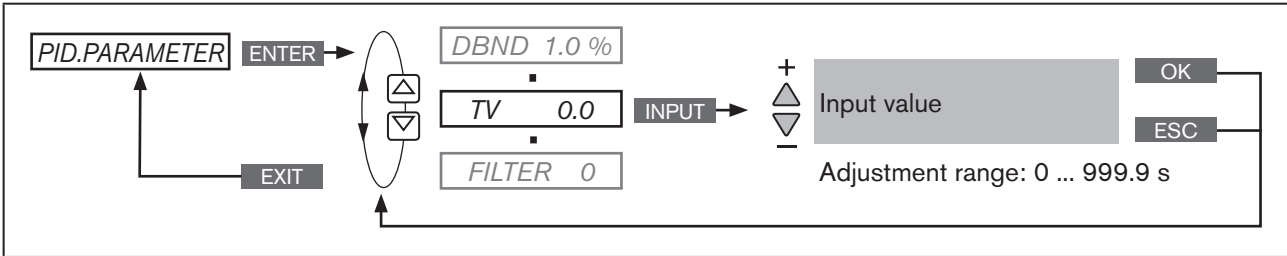


Figure 56: Operating structure TV; hold-back time

24.3.6 X0 – Operating point of the process controller

The operating point corresponds to the size of the proportional portion when control difference = 0.

Factory setting: 0.0 %

Operating structure:

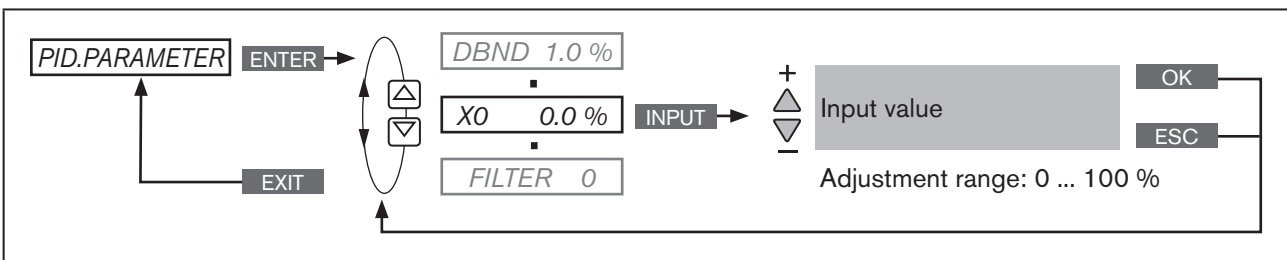


Figure 57: Operating structure X0; operating point

24.3.7 FILTER – Filtering of the process actual value input

The filter is valid for all process actual value types and has a low pass behavior (PT1).

Factory setting: 0

Operating structure:

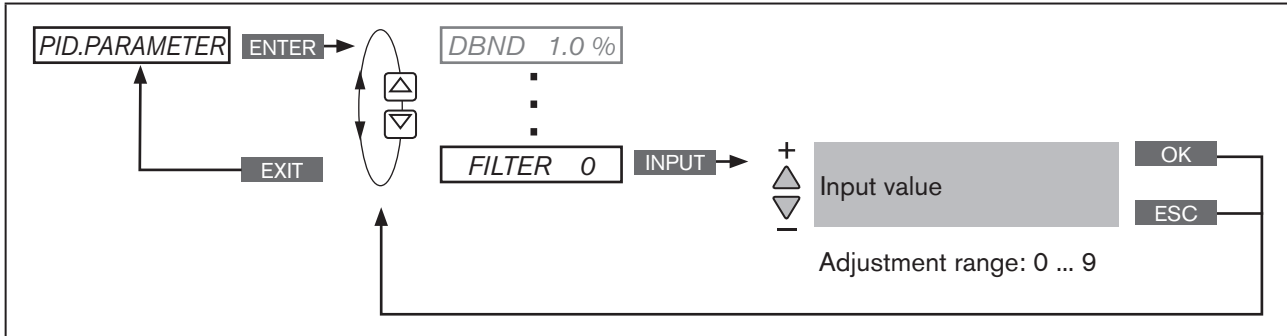


Figure 58: Operating structure FILTER; filtering of the process actual value input

Setting the filter effect in 10 stages

Setting	Corresponds to cut-off frequency (Hz)	Effect
0	10	Lowest filter effect
1	5	
2	2	
3	1	
4	0.5	
5	0.2	
6	0.1	
7	0.07	
8	0.05	
9	0.03	Largest filter effect

Table 44: Setting the filter effect



On page 249 you will find a table for entering your set parameters.

24.4 P.Q'LIN – Linearization of the process characteristic

This function automatically linearizes the process characteristic.

In doing so, the nodes for the correction characteristic are automatically determined. To do this, the program moves through the valve stroke in 20 steps and measures the associated process variable.

The correction characteristic and the associated value pairs are saved in the menu option *CHARACT* → *FREE*. This is where they can be viewed and freely programmed. For a description see chapter "25.2.1".

If the *CHARACT* menu option has still not been activated and incorporated into the main menu (MAIN), this will happen automatically when *P.Q'LIN* is being run.

Run P.Q'LIN:





Key	Action	Description
▲ / ▼	Select <i>P.Q'LIN</i>	The function is in the main menu (MAIN) after activation of <i>P.CONTROL</i> .
	 Hold down as long as countdown (5 ...) is running	<i>P.Q'LIN</i> is started.
	The following displays are indicated on the display:	
	<i>Q'LIN</i> #0 <i>CMD</i> =0% <i>Q.LIN</i> #1 <i>CMD</i> =10% ... continuing to <i>Q.LIN</i> #10 <i>CMD</i> =100%	Display of the node which is currently running (progress is indicated by a progress bar along the upper edge of the display).
	<i>Q.LIN</i> <i>ready</i>	Automatic linearization was successfully completed.
	Press 	Return to the main menu (MAIN).

Table 45: *P.Q'LIN*; Automatic linearization of the process characteristic

Possible error messages when running *P.Q'LIN*:


Display	Cause of fault	Remedial action
<i>Q.LIN</i> <i>err/break</i>	Manual termination of linearization by pressing the  key.	
<i>P.Q'LIN</i> <i>ERROR 1</i>	No supply pressure connected.	Connect supply pressure.
	No change to process variable.	Check process and, if required, switch on pump or open the shut-off valve. Check process sensor.
<i>P.Q'LIN</i> <i>ERROR 2</i>	Failure of the supply pressure while <i>P.Q'LIN</i> running.	Check supply pressure.
	Automatic adjustment of the <i>X.TUNE</i> position controller not run.	Run <i>X.TUNE</i> .

Table 46: *P.Q'LIN*; possible error messages

24.5 *P.TUNE* – Self-optimization of the process controller

This function can be used to automatically parameterize the PID controller integrated in the process controller.

In doing so, the parameters for the P, I and D-contribution of the PID controller are automatically determined and transferred to the corresponding menus of (*KP*, *TN*, *TV*). This is where they can be viewed and changed.

Explanation of the PID controller:

The control system of Type 8693 has an integrated PID process controller. Any process variable, such as flow rate, temperature, pressure, etc., can be controlled by connecting an appropriate sensor.

To obtain good control behavior, the structure and parameterization of the PID controller must be adjusted to the properties of the process (controlled section).

This task requires control experience as well as measuring instruments and is time-consuming. The *P.TUNE* function can be used to automatically parameterize the PID controller integrated in the process controller.



Basic information for setting the process controller can be found in chapters [“39 Properties of PID Controllers”](#) and [“40 Adjustment rules for PID Controllers”](#).

24.5.1 The mode of operation of *P.TUNE*

The *P.TUNE* function automatically identifies the process. To do this, the process is activated with a defined disturbance variable. Typical process characteristics are derived from the response signal and the structure and parameters of the process controller are determined on the basis of the process characteristics.

When using *P.TUNE* self-optimization, optimum results are obtained under the following conditions:

- Stable or stationary conditions concerning the process actual value *PV* when starting *P.TUNE*.
- Execution of *P.TUNE* in the operating point or within the operating range of the process control.

24.5.2 Preparatory measure for execution of *P.TUNE*



The measures described below are not compulsory conditions for execution of the function *P.TUNE*. However, they will increase the quality of the result.

The *P.TUNE* function can be run in the MANUAL or AUTOMATIC operating state.

When *P.TUNE* is complete, the control system is in the operating state which was set previously.

24.5.2.1. Preparatory measures for execution of *P.TUNE* in the MANUAL operating state

Moving process actual value *PV* to the operating point:



Key	Action	Description
Setting on the process level:		
▲ / ▼	Select <i>PV</i>	The process actual value <i>PV</i> is indicated on the display.
MANU	Press 	Change to MANUAL operating state. The input screen for manually opening and closing the valve is displayed.
▲	Open valve OPN or	By opening or closing the control valve, move the process actual value to the required operating point.
▼	Close valve CLS	
As soon as the process actual value <i>PV</i> is constant, the <i>P.TUNE</i> function can be started.		

Table 47: *P.TUNE*; preparatory measure for running *X.TUNE* in the MANUAL operating state

24.5.2.2. Preparatory measure for execution of *P.TUNE* in the AUTOMATIC operating state

By inputting a process set-point value *SP*, move the process actual value *PV* to the operating point.

 **Observe the internal or external set-point value default for the input (*P.CONTROL* → *SETUP* → *SP-INPUT* → *intern/extern*):**

For internal set-point value default: Input the process set-point value *SP* via the device keyboard see description below "[Table 48](#)".

For external set-point value default: Input the process set-point value *SP* via the analog set-point value input.

Inputting a process set-point value:




Key	Action	Description
Setting on the process level:		
▲ / ▼	Select <i>SP</i>	The process set-point value is indicated on the display.
INPUT	Press 	The input screen for inputting the process set-point value is displayed.
▲ / ▼	Input value <- Select decimal place + Increase value	The selected set-point value <i>SP</i> should be near the future operating point.
OK	Press 	Acknowledge input and return to the display of <i>SP</i> .

Table 48: *P.TUNE*; preparatory measure for running *X.TUNE* in the AUTOMATIC operating state

The process variable *PV* is changed according to the set-point value default based on the factory default PID parameters.

→ Before running the *P.TUNE* function, wait until the process actual value *PV* has reached a stable state.

 To observe *PV*, it is recommended to select via the arrow keys ▲ / ▼ the graphical display *SP/PV(t)*.
To be able to select the display *SP/PV(t)*, it must be activated in the EXTRAS menu (see chapter “25.2.18 EXTRAS – Setting the display”).

→ If *PV* oscillates continuously, the preset amplification factor of the process controller *KP* in the menu *P.CONTROL* → *PID.PARAMETER* should be reduced.

→ As soon as the process actual value *PV* is constant, the *P.TUNE* function can be started.

24.5.3 Starting the function *P.TUNE*

WARNING!

Risk of injury from uncontrolled process!

While the *P.TUNE* function is running, the control valve automatically changes the current degree of opening and intervenes in the running process.

- ▶ Using suitable measures, prevent the permitted process limits from being exceeded.
For example by:
 - an automatic emergency shutdown
 - stopping the *P.TUNE* function by pressing the STOP key (press left or right key).

Procedure:










Key	Action	Description
	Press  for approx. 3 s	Switching from process level ⇌ setting level
▲ / ▼	Select <i>P.TUNE</i>	
	 Hold down as long as countdown (5 ...) is running	During the automatic adjustment the following messages are indicated on the display. " <i>starting process tune</i> " - Start self-optimization. " <i>identifying control process</i> " - Process identification. Typical process variables are determined from the response signal to a defined stimulus. " <i>calculating PID parameters</i> " - Structure and parameters of the process controller are determined. " <i>TUNE ready</i> " - Self-optimization was successfully completed.
	Press any key	Return to the main menu (MAIN).
	Press 	Switching from setting level ⇌ process level.

Table 49: Automatic adjustment of *X.TUNE*

 To stop *P.TUNE*, press the left or right selection key .

 The changed data is saved in the memory (EEPROM) only when there is a switch to the process level, by leaving the main menu (MAIN) using the left selection key . During the save process, the save symbol is indicated  on the display.

Possible error messages when running *P.TUNE*:

Display	Cause of fault	Remedial action
<i>TUNE</i> <i>err/break</i>	Manual termination of self-optimization by pressing the EXIT key.	
<i>P.TUNE</i> <i>ERROR 1</i>	No supply pressure connected.	Connect supply pressure.
	No change to process variable.	Check process and, if required, switch on pump or open the shut-off valve. Check process sensor.

Table 50: *P.TUNE*; possible error messages

After making all the settings described in chapter "[Start-Up](#)", the process controller is ready for use.

Activation and configuration of auxiliary functions is described in the following chapter "[25 Configuring the auxiliary functions](#)".

Auxiliary functions

CONTENTS

25	CONFIGURING THE AUXILIARY FUNCTIONS.....	108
25.1	Activating and deactivating auxiliary functions.....	108
25.1.1	Including auxiliary functions in the main menu.....	108
25.1.2	Removing auxiliary functions from the main menu	109
25.1.3	Principle of including auxiliary functions in the main menu.....	109
25.2	Overview and description of the auxiliary functions.....	110
25.2.1	CHARACT – Select the transfer characteristic between input signal (position set-point value) and stroke	111
25.2.2	CUTOFF – Sealing function	115
25.2.3	DIR.CMD – Sense of effective direction of the positioner set-point value	117
25.2.4	DIR.ACT – Sense of effective direction of the actuating drive.....	118
25.2.5	SPLTRNG – Signal split range.....	119
25.2.6	X.LIMIT – Limits the mechanical stroke range.....	120
25.2.7	X.TIME – Limiting the control speed.....	121
25.2.8	X.CONTROL – Parameterization of the positioner	122
25.2.9	P.CONTROL – Setting up and parameterization of the process controller.....	123
25.2.10	SECURITY – Code protection for the settings	124
25.2.11	SAFEPOS – Input the safety position	126
25.2.12	SIG.ERROR – Configuration of signal level fault detection	127
25.2.13	BINARY.IN – Activation of the binary input	128
25.2.14	OUTPUT – Configuring the outputs (option).....	130
25.2.15	CAL.USER – Calibration of actual value and set-point value	136
25.2.16	SET.FACTORY – Resetting to the factory settings.....	141
25.2.17	SER. I/O – Settings of the serial interface.....	142
25.2.18	EXTRAS – Setting the display	143
25.2.19	SERVICE	145
25.2.20	SIMULATION – Menu for simulation of set-point value, process and process valve.....	146
25.2.21	DIAGNOSE – Menu for monitoring valves (option).....	151
25.3	Manual configuration of X.TUNE	171
25.3.1	Description of the menu for the manual configuration of X.TUNE.....	172

25 CONFIGURING THE AUXILIARY FUNCTIONS

The device has auxiliary functions for demanding control tasks.

This chapter describes how the auxiliary functions are activated, set and configured.






25.1 Activating and deactivating auxiliary functions

The required auxiliary functions must be activated by the user initially by incorporation into the main menu (MAIN). The parameters for the auxiliary functions can then be set.




To deactivate a function, remove it from the main menu. This will cause the previous settings, created under this function, to be rendered invalid again.

25.1.1 Including auxiliary functions in the main menu

Procedure:

Key	Action	Description
MENU	Press  for approx. 3 s	Switching from process level \Rightarrow setting level.
▲ / ▼	Select <i>ADD.FUNCTION</i>	
ENTER	Press 	The possible auxiliary functions are displayed.
▲ / ▼	Select required auxiliary function	
ENTER	Press 	The selected auxiliary function is now marked by a cross  .
EXIT	Press 	Acknowledgment and simultaneous return to the main menu (MAIN). The marked function is now activated and incorporated into the main menu.


The parameters can then be set as follows.

▲ / ▼	Select the auxiliary function	In the main menu (MAIN) select the auxiliary function.
ENTER	Press 	Opening the submenu to input the parameters. Further information about the setting can be found in the following chapter " 25.2 Overview and description of the auxiliary functions ", page 110
EXIT * ESC *	Press 	Return to a higher level or to the main level (MAIN).
EXIT	Press 	Switching from setting level \Rightarrow process level.

* The designation of the key depends on the selected auxiliary function.

Table 51: Incorporating auxiliary functions



The changed data is saved in the memory (EEPROM) only when there is a switch to the process level, by leaving the main menu (MAIN) using the left selection key **EXIT**. During the save process, the save symbol is indicated  on the display.

25.1.2 Removing auxiliary functions from the main menu

! If a function is removed from the main menu, the settings implemented previously under this function become invalid again.

Procedure:

Key	Action	Description
MENU	Press for approx. 3 s	Switching from process level ⇌ setting level.
▲ / ▼	Select ADD.FUNCTION	
ENTER	Press	The possible auxiliary functions are displayed.
▲ / ▼	Select the auxiliary function	
ENTER	Press	Remove function mark (no cross <input type="checkbox"/>)
EXIT	Press	Acknowledgment and simultaneous return to the main menu (MAIN). The marked function is now deactivated and removed from the main menu.

Table 52: Removing auxiliary functions

25.1.3 Principle of including auxiliary functions in the main menu

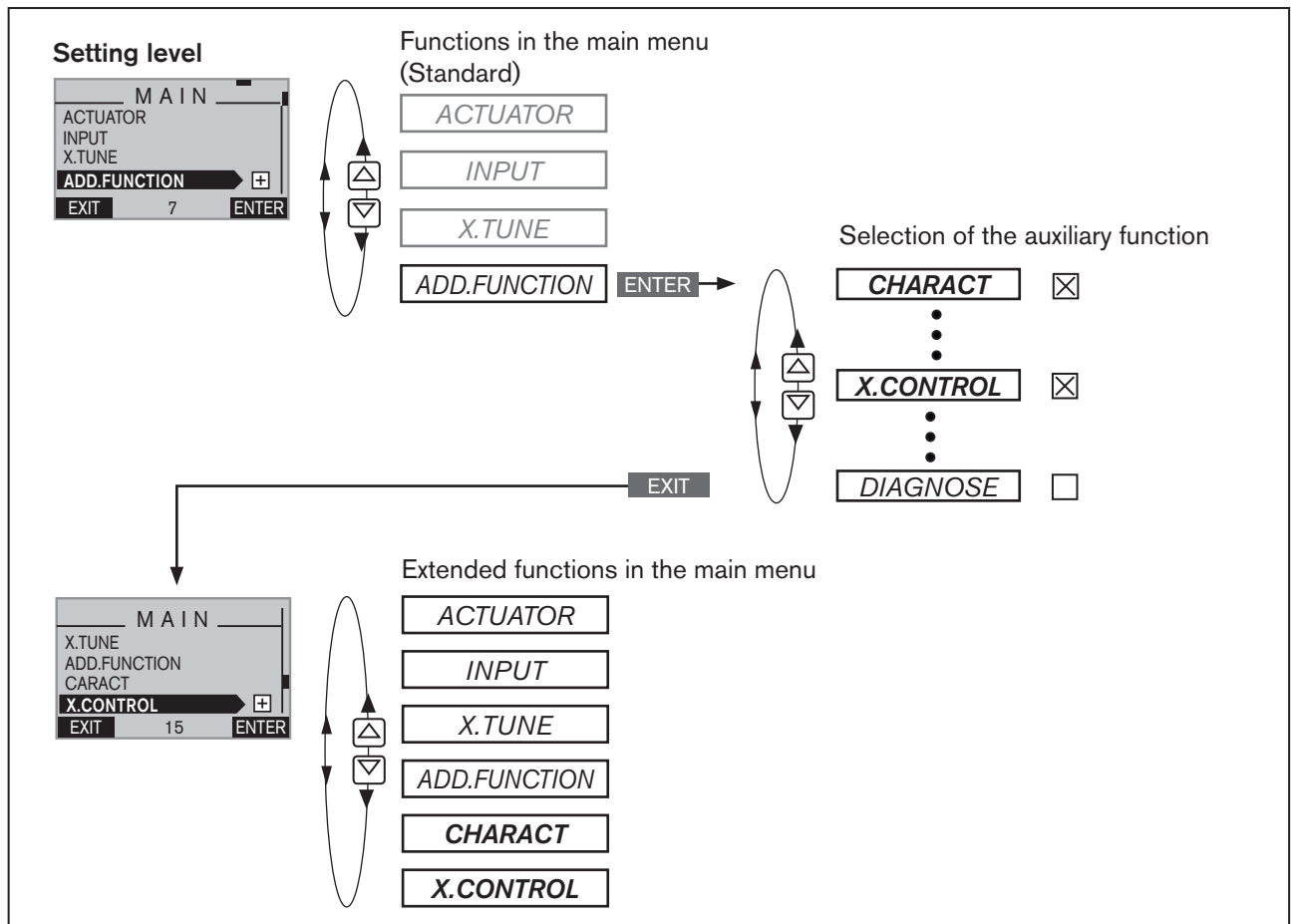


Figure 59: Incorporating auxiliary functions into the main menu

MAN 1000108626 EN Version: F Status: RL (released | freigegeben) printed: 20.01.2015

25.2 Overview and description of the auxiliary functions

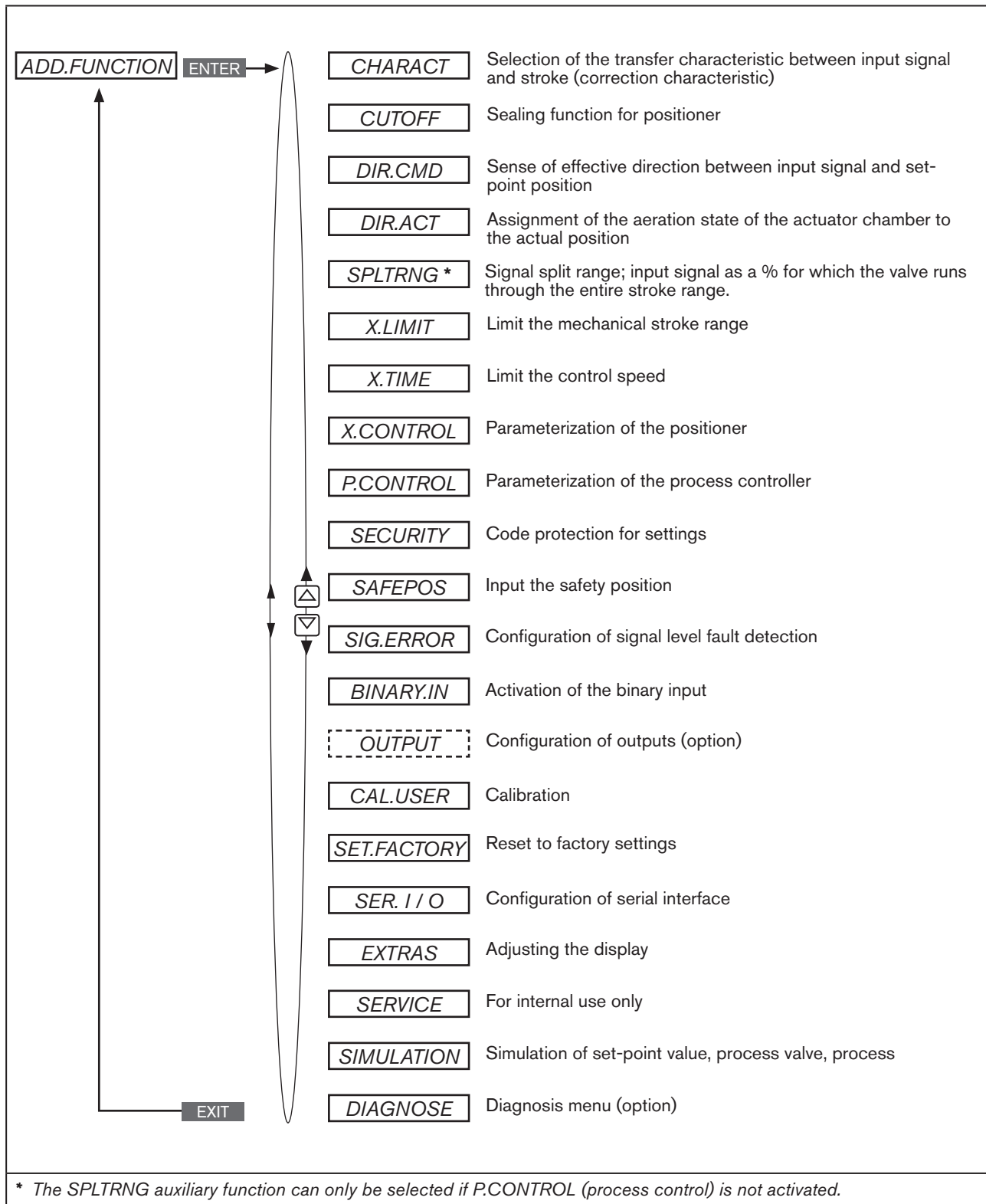


Figure 60: Overview - auxiliary functions

25.2.1 CHARACT – Select the transfer characteristic between input signal (position set-point value) and stroke

Characteristic (customer-specific characteristic)

Use this auxiliary function to select a transfer characteristic with reference to set-point value (set-point position, *CMD*) and valve stroke (*POS*) for correction of the flow-rate or operating characteristic.

Factory setting: *linear*



Each auxiliary function, which is to be set, must be incorporated initially into the main menu (MAIN). See chapter “25.1 Activating and deactivating auxiliary functions”, page 108.

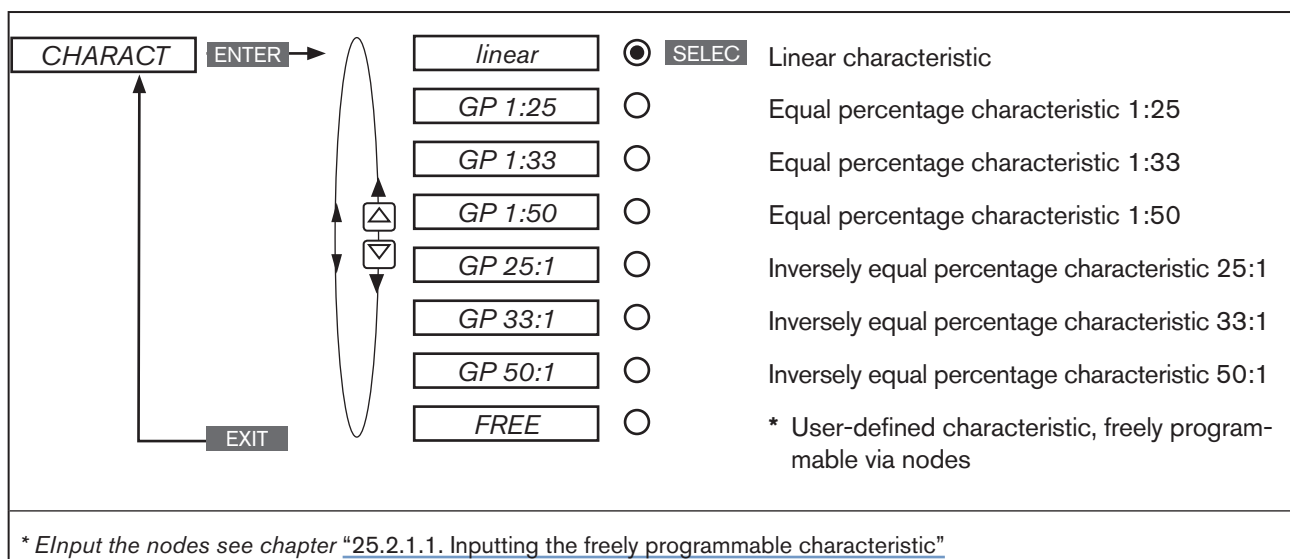


Figure 61: Operating structure CHARACT

The flow characteristic $k_v = f(s)$ indicates the flow-rate of a valve, expressed by the k_v value depending on the stroke s of the actuator spindle. It is specified by the design of the valve seat and the seat seal. In general two types of flow characteristics are implemented, the linear and the equal percentage.

In the case of linear characteristics identical k_v value changes dk_v are assigned to identical stroke changes ds .

$$(dk_v = n_{lin} \cdot ds).$$

In the case of an equal percentage characteristic an equal percentage change of the k_v value corresponds to a stroke change ds .

$$(dk_v/k_v = n_{equalper} \cdot ds).$$

The operating characteristic $Q = f(s)$ specifies the correlation between the volumetric flow Q in the installed valve and the stroke s . This characteristic has the properties of the pipelines, pumps and consumers. It therefore exhibits a form which differs from the flow characteristic.

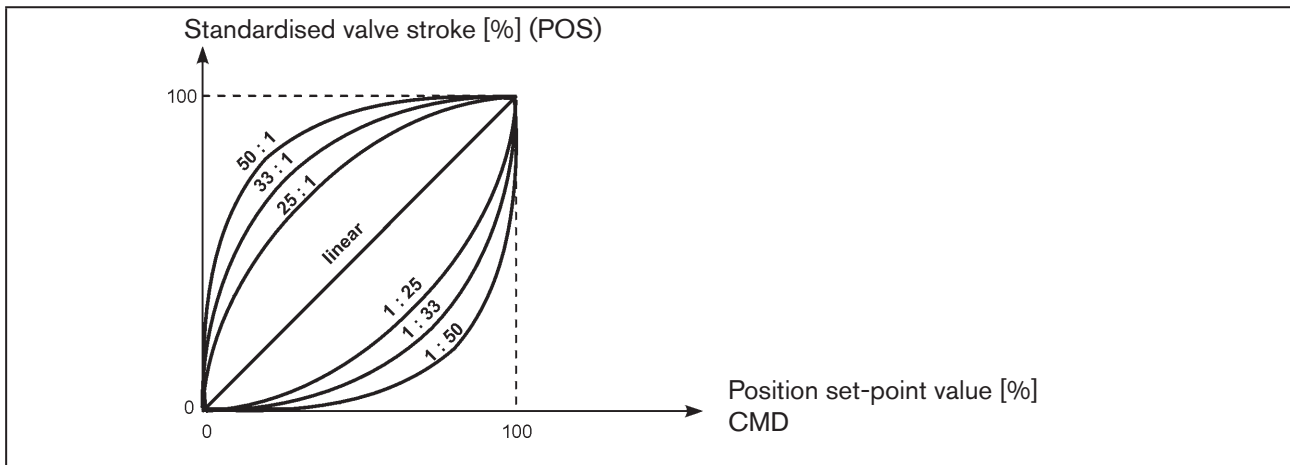


Figure 62: Characteristics

In the case of control tasks for closed-loop control systems it is usually particular demands which are placed on the course of the operating characteristic, e.g. linearity. For this reason it is occasionally necessary to correct the course of the operating characteristic in a suitable way. For this purpose the Type 8692/8693 features a transfer element which implements different characteristics. These are used to correct the operating characteristic.

Equal percentage characteristics 1:25, 1:33, 1:50, 25:1, 33:1 and 50:1 and a linear characteristic can be set. Furthermore, a characteristic can be freely programmed via nodes or automatically calibrated.

25.2.1.1. Inputting the freely programmable characteristic

The characteristic is defined via 21 nodes which are distributed uniformly via the position set-point values ranging from 0 – 100 %. Their distance is 5 %. A freely selectable stroke (adjustment range 0 – 100 %) is assigned to each node. The difference between the stroke values of two adjacent nodes must not be larger than 20 %.

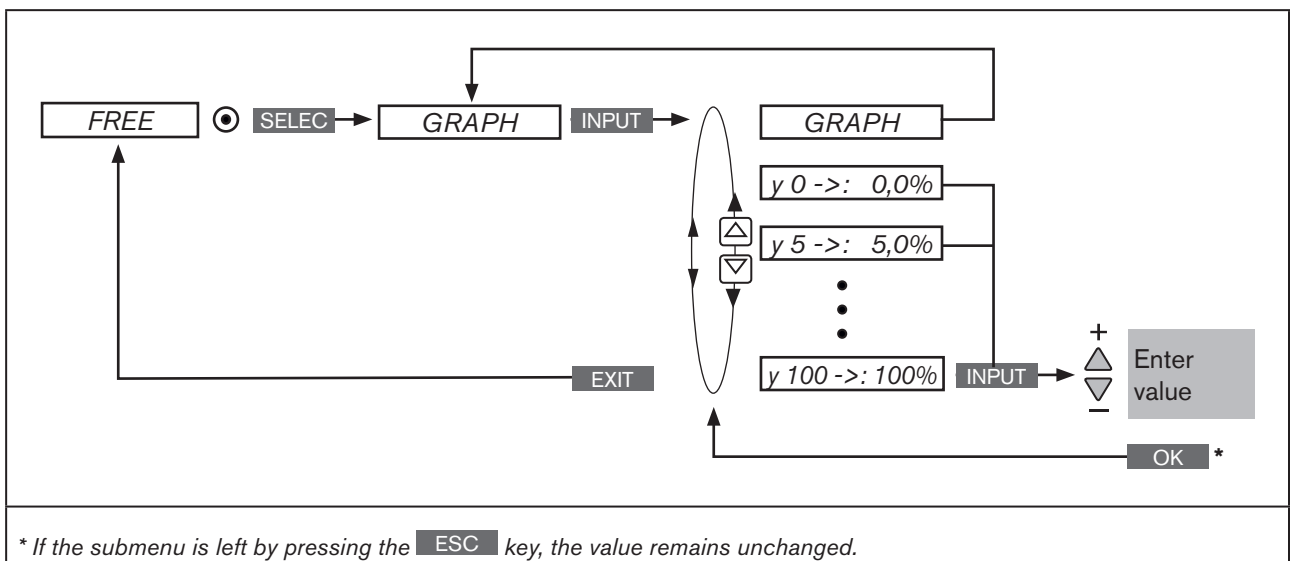


Figure 63: Operating structure CHARACT FREE

Procedure:

Key	Action	Description
MENU	Press for approx. 3 s	Switching from process level ⇔ setting level.
▲ / ▼	Select <i>CHARACT</i>	(To do this, the auxiliary function must be incorporated into the main menu).
ENTER		Menu options of <i>CHARACT</i> are displayed.
▲ / ▼	Select <i>FREE</i>	
SELEC	Press	The graphical display of the characteristic is displayed.
INPUT	Press	Submenu with the individual nodes (as %) is opened.
▲ / ▼	Select node	
INPUT	Press	The <i>SET-VALUE</i> input screen for inputting values is opened. <ul style="list-style-type: none"> Previously set value (as %) This value is changed with the arrow keys Acknowledge value Return without change
▲ / ▼	Input value: Increase value Reduce value	Input value for the selected node.
OK	Press	Acknowledge input and return to the <i>FREE</i> submenu.
EXIT	Press	Return to the <i>CHARACT</i> menu.
EXIT	Press	Return to the main menu (MAIN).
EXIT	Press	Switching from setting level ⇔ process level. The changed data is saved in the memory (EEPROM).

Table 53: *FREE; Inputting the freely programmable characteristic*

The changed data is saved in the memory (EEPROM) only when there is a switch to the process level, by leaving the main menu (MAIN) using the left selection key **EXIT**. During the save process, the save symbol is indicated on the display.

Example of a programmed characteristic

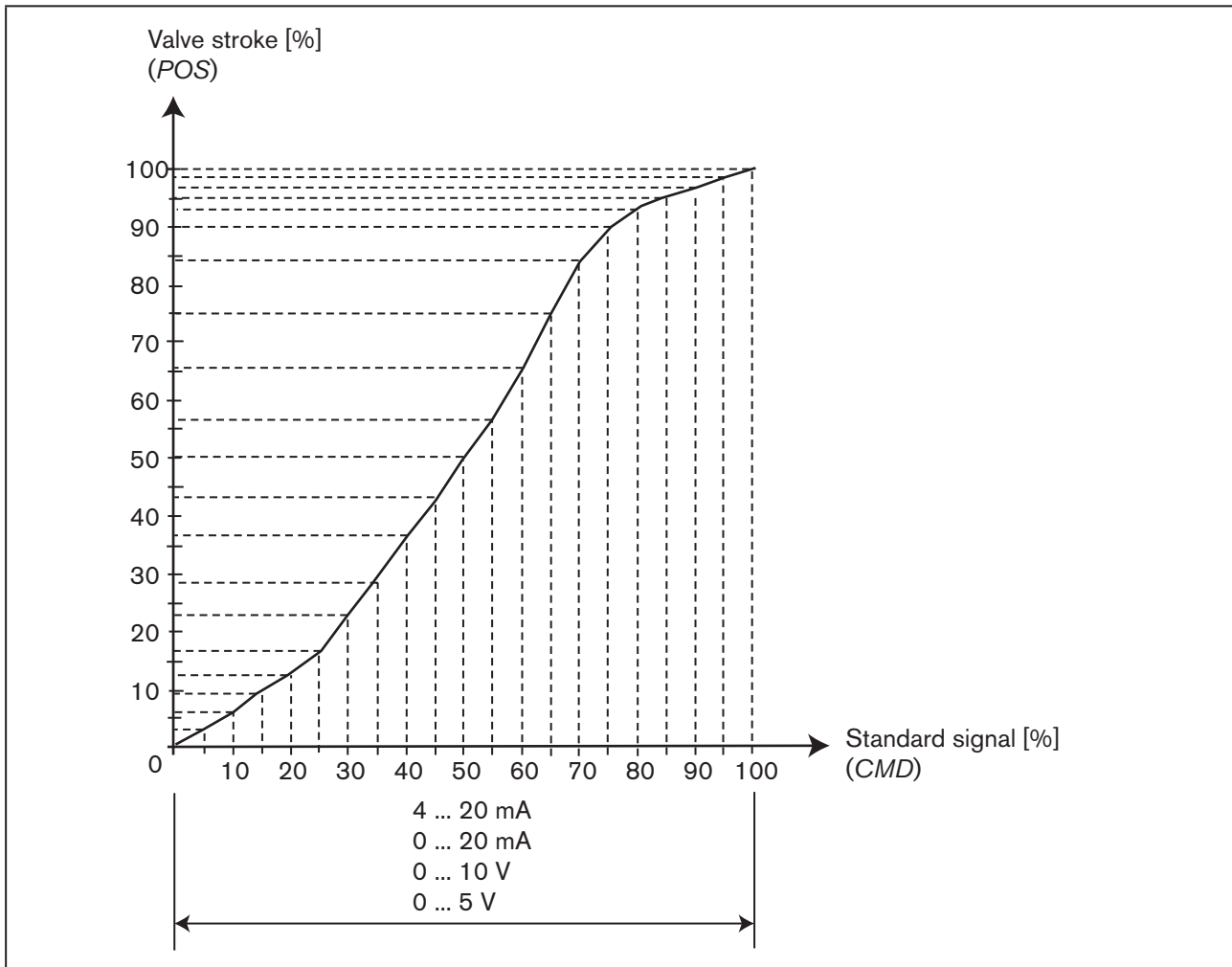


Figure 64: Example of a programmed characteristic



In the section “[Tables for customer-specific settings](#)” in chapter “[41.1. Settings of the freely programmable characteristic](#)” there is a table in which you can enter your settings for the freely programmable characteristic.

25.2.2 CUTOFF – Sealing function

This function causes the valve to be sealed outside the control area.

This is where you input the limits for the position set-point value (CMD) as a percentage, from which the actuator is fully deaerated or aerated.

Controlled operation opens or resumes at a hysteresis of 1 %.

If the process valve is in the sealing area, the message „CUTOFF ACTIVE“ is indicated on the display.

Only for type 8693: Here you can select the set-point value to which the sealing function is to apply:

Type PCO Process set-point value (SP)

Type XCO Position set-point value (CMD)

If *Type PCO* was selected, the limits for the process set-point value (SP) are input as a percentage with reference to the scaling range.

Factory setting: *Min = 0 %;* *Max = 100 %;* *CUT type = Type PCO*

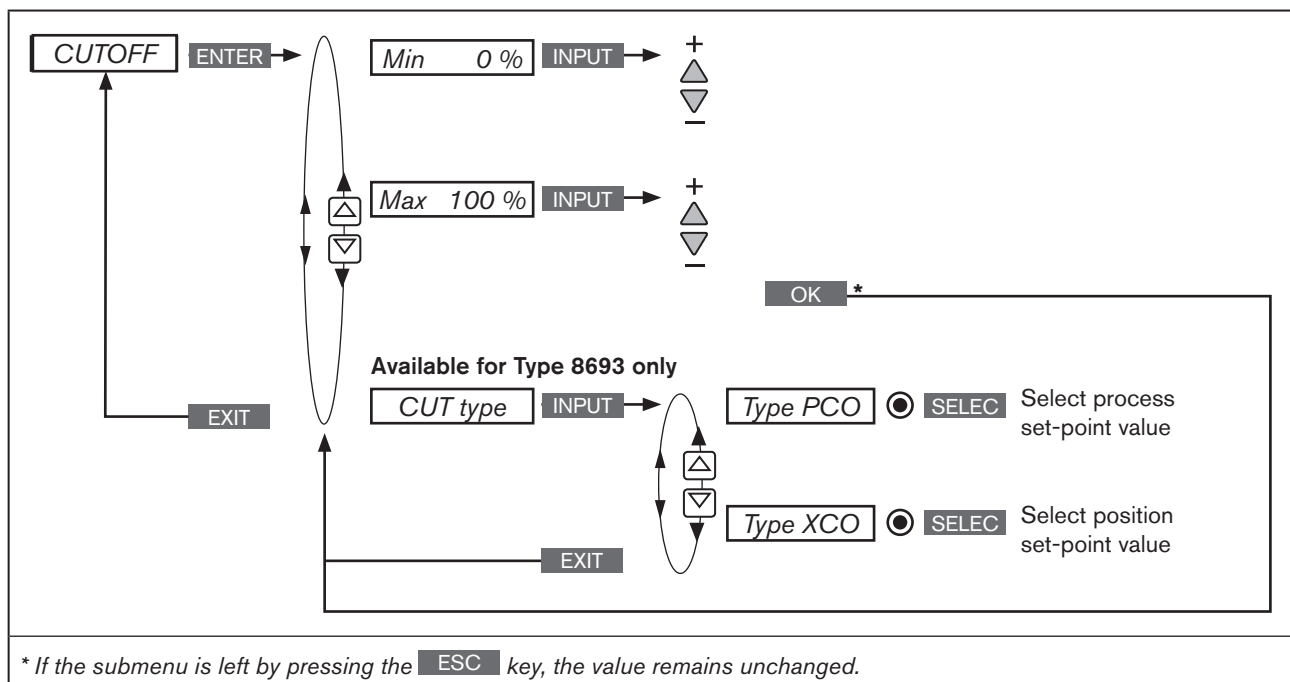



Figure 65: Operating structure CUTOFF

! The changed data is saved in the memory (EEPROM) only when there is a switch to the process level, by leaving the main menu (MAIN) using the left selection key **EXIT**. During the save process, the save symbol is indicated  on the display.

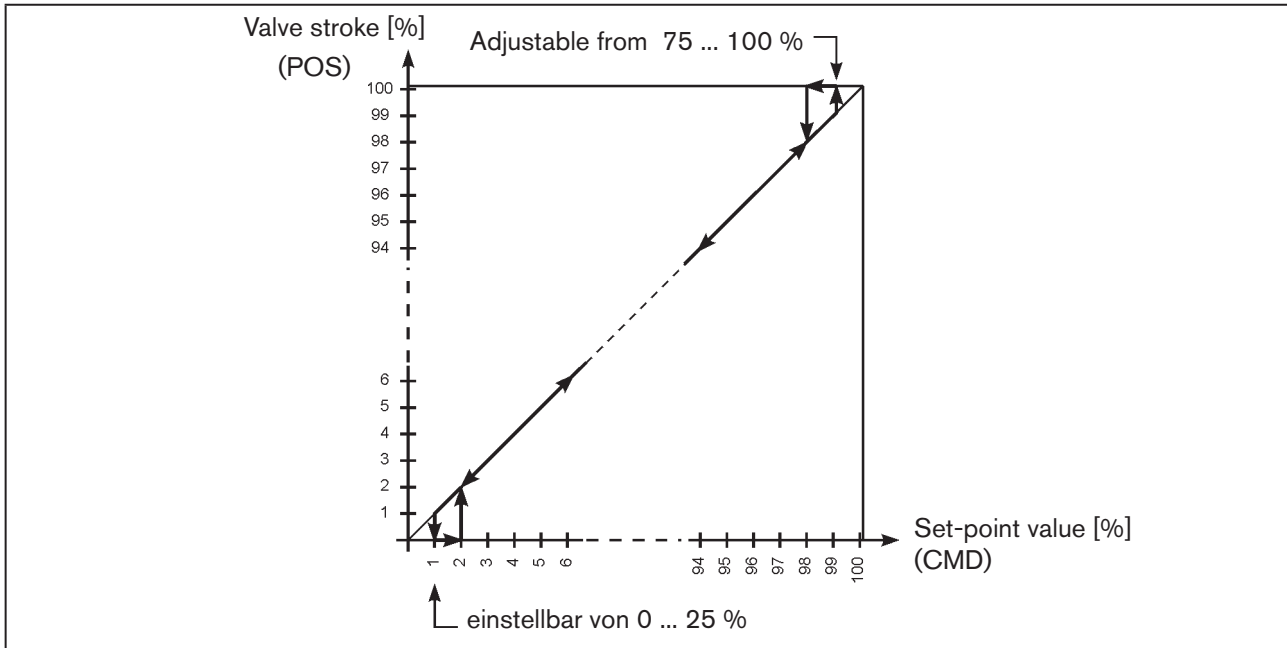


Figure 66: Graph - CUTOFF;

25.2.3 DIR.CMD – Sense of effective direction of the positioner set-point value

Use this auxiliary function to set the sense of effective direction between the input signal (*INPUT*) and the set-point position (*CMD*) of the actuator.

! Each auxiliary function, which is to be set, must be incorporated initially into the main menu (MAIN). See chapter “25.1 Activating and deactivating auxiliary functions”.

Factory setting: *Rise*

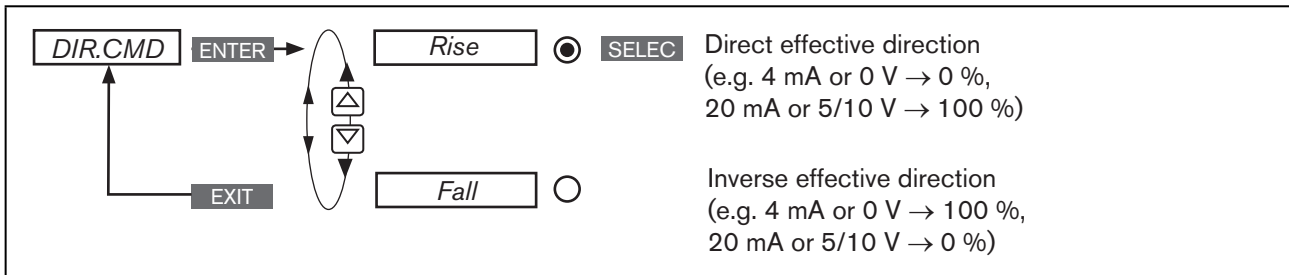



Figure 67: Operating structure DIR.CMD

! The changed data is saved in the memory (EEPROM) only when there is a switch to the process level, by leaving the main menu (MAIN) using the left selection key **EXIT**. During the save process, the save symbol is indicated  on the display.

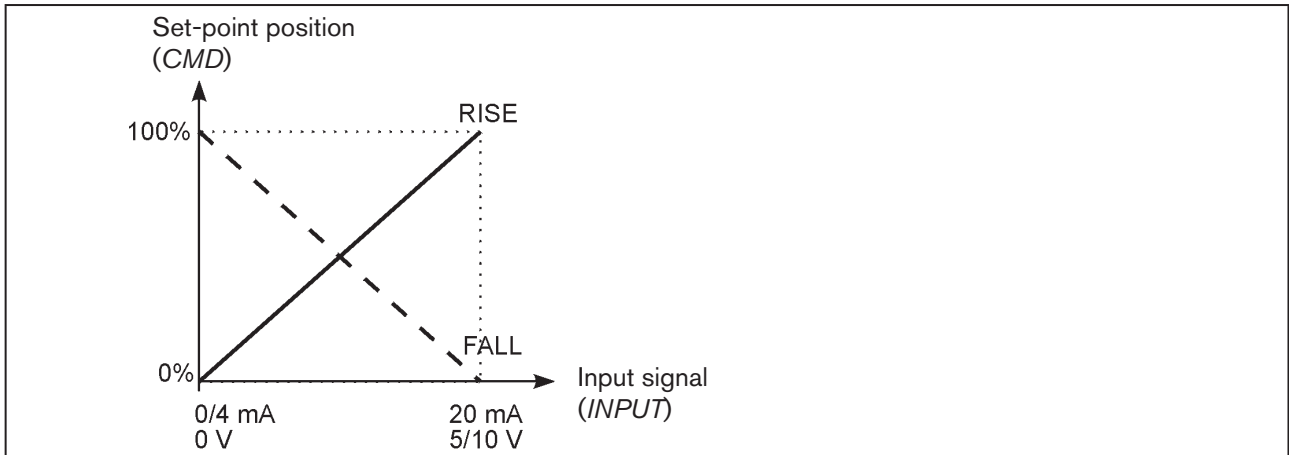


Figure 68: Graph - DIR.CMD

25.2.4 DIR.ACT – Sense of effective direction of the actuating drive

Use this auxiliary function to set the sense of effective direction between the aeration state of the actuator and the actual position (POS).

Factory setting: *Rise*

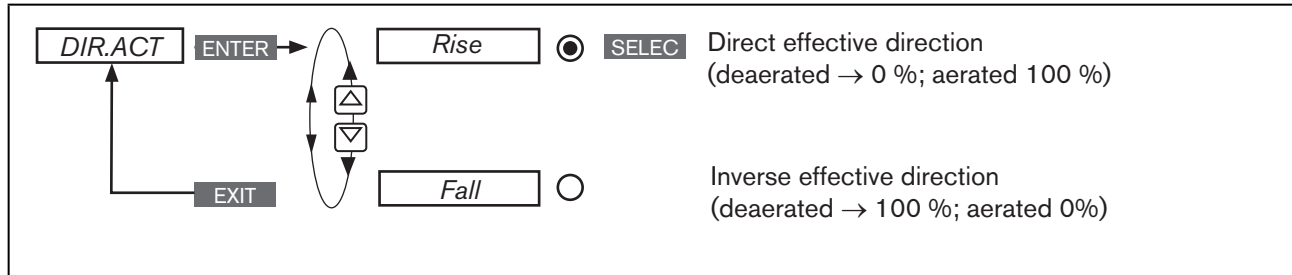



Figure 69: Operating structure DIR.ACT



If the *Fall* function is selected, the description of the arrow keys (on the display) changes in the MANUAL operating state

OPN → CLS and CLS → OPN

The changed data is saved in the memory (EEPROM) only when there is a switch to the process level, by leaving the main menu (MAIN) using the left selection key **EXIT**. During the save process, the save symbol  on the display.

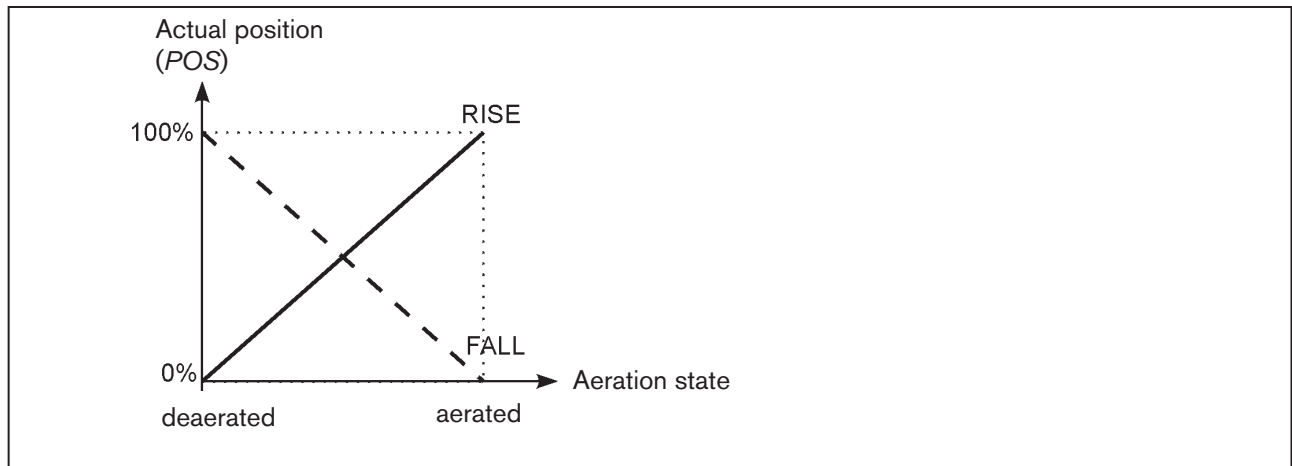


Figure 70: Graph - DIR.ACT

25.2.5 SPLTRNG – Signal split range

Min. and max. values of the input signal as % for which the valve runs through the entire stroke range.

Factory setting: $Min = 0\%$; $Max = 100\%$



Type 8693: The *SPLTRNG* auxiliary function can only be selected when operating as a positioner (position controller).

P.CONTROL = not activated.

Use this auxiliary function to limit the position set-point value range of the Type 8692/8693 by specifying a minimum and a maximum value.

As a result, it is possible to divide a utilised standard signal range (4 – 20 mA; 0 – 20 mA; 0 – 10 V or 0 – 5 V) into several devices (without or with overlapping).

This allows several valves to be used **alternately** or in the case of overlapping set-point value ranges **simultaneously** as actuating element.

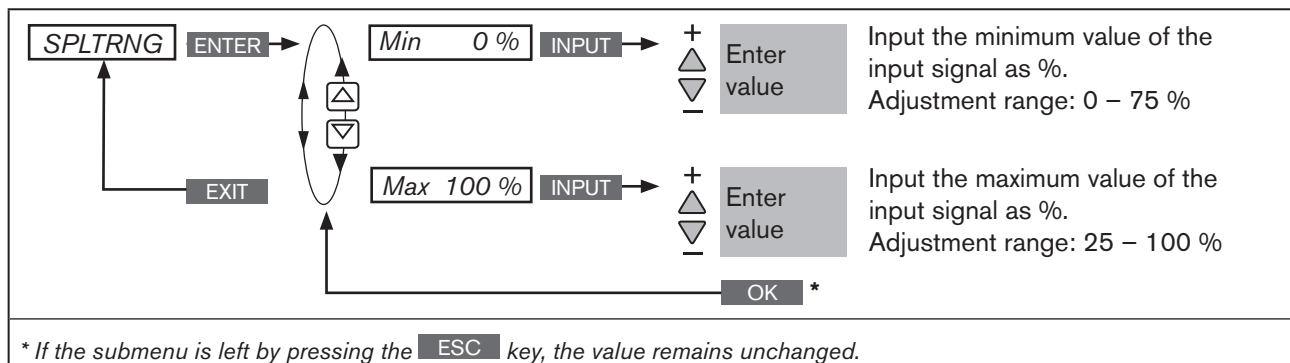



Figure 71: Operating structure *SPLTRNG*



The changed data is saved in the memory (EEPROM) only when there is a switch to the process level, by leaving the main menu (MAIN) using the left selection key **EXIT**. During the save process, the save symbol is indicated  on the display.

Splitting a standard signal range into two set-point value ranges

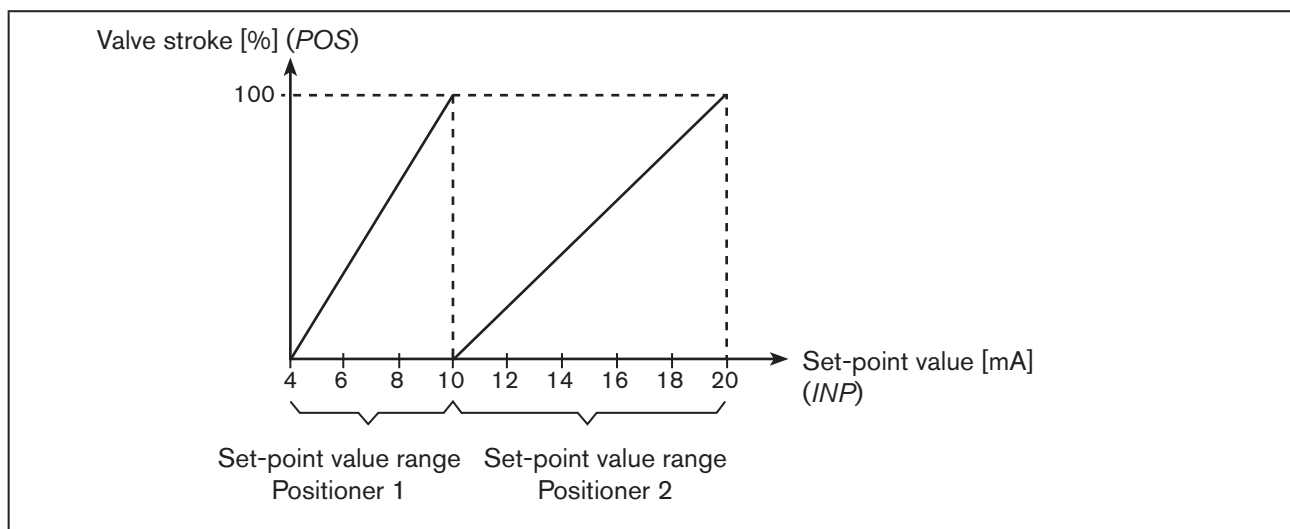


Figure 72: Graph - *SPLTRNG*

25.2.6 X.LIMIT – Limits the mechanical stroke range

This auxiliary function limits the (physical) stroke to specified % values (minimum and maximum). In doing so, the stroke range of the limited stroke is set equal to 100 %.

If the limited stroke range is left during operation, negative POS values or POS values greater than 100 % are indicated.

Factory setting: $Min = 0 \%$, $Max = 100 \%$

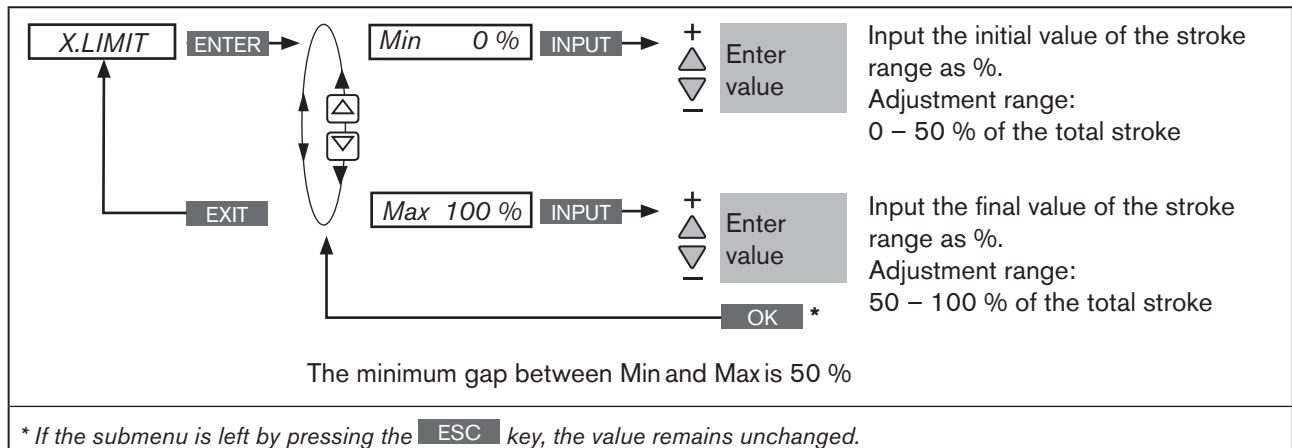



Figure 73: Operating structure X.LIMIT

! The changed data is saved in the memory (EEPROM) only when there is a switch to the process level, by leaving the main menu (MAIN) using the left selection key **EXIT**. During the save process, the save symbol is indicated  on the display.

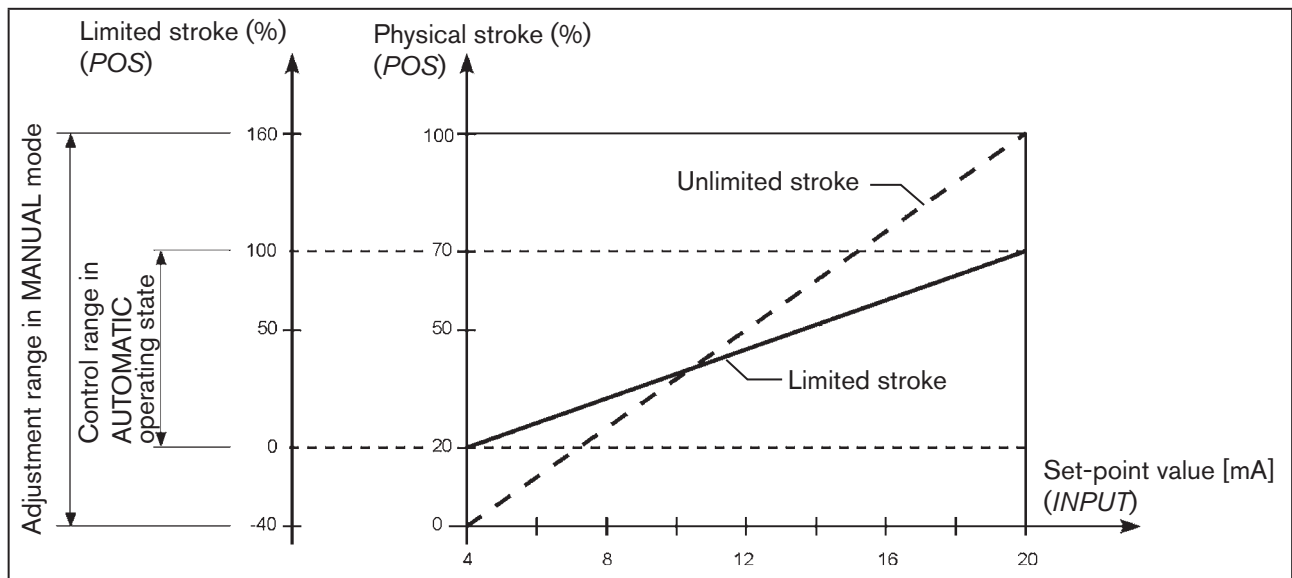


Figure 74: Graph - X.LIMIT

25.2.7 X.TIME – Limiting the control speed

Use this auxiliary function to specify the opening and closing times for the entire stroke and limit the control speeds.



When the *X.TUNE* function is running, the minimum opening and closing time for the entire stroke is automatically entered for *Open* and *Close*. Therefore, movement can be at maximum speed.

Factory setting: values determined at the factory by the *X.TUNE*

If the control speed is limited, values can be input for *Open* and *Close* which are between the minimum values determined by the *X.TUNE* and 60 s.

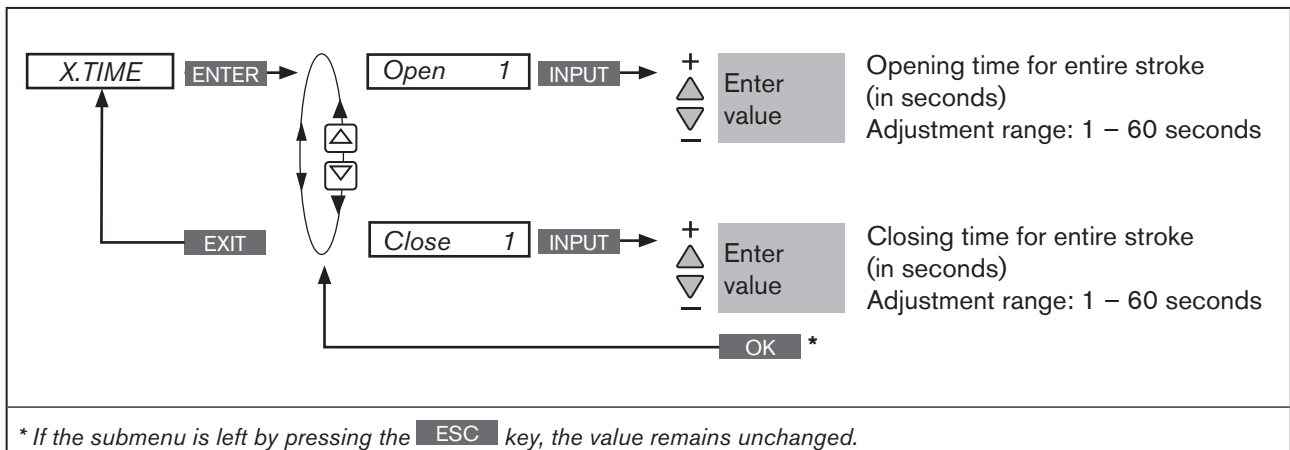


Figure 75: Operating structure *X.TIME*



The changed data is saved in the memory (EEPROM) only when there is a switch to the process level, by leaving the main menu (MAIN) using the left selection key **EXIT**. During the save process, the save symbol is indicated on the display.

Effect of limiting the opening speed when there is a jump in the set-point value

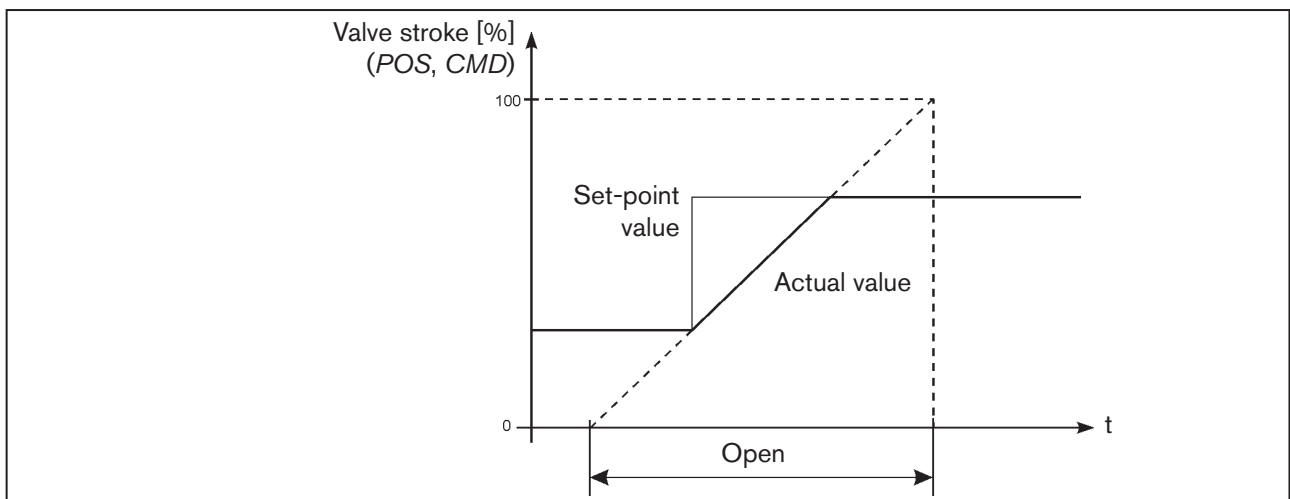


Figure 76: Graph - *X.TIME*

25.2.8 X.CONTROL – Parameterization of the positioner

This function can be used to re-adjust the parameters of the positioner.
The re-adjustment should only be made if it is required for the application.

The parameters for X.CONTROL are automatically set with the exception of DBND (dead band) when specifying the basic settings by running X.TUNE.



If the setting for DBND (dead band depending on the friction behavior of the actuating drive) is also to be automatically determined when X.TUNE is running, X.CONTROL must be activated by incorporating it into the main menu (MAIN).

When X.TUNE is running, all previously re-adjusted values are overwritten (except the X.TUNE function was manually parameterized).

- DBND** Insensitivity range (dead band)
- KXopn** Amplification factor of the proportional portion (for aerating the valve)
- KXcls** Amplification factor of the proportional portion (for bleeding the valve)
- KDopn** Amplification factor of the differential portion (for aerating the valve)
- KDcls** Amplification factor of the differential portion (for bleeding the valve)
- YBfric** Friction correction (for aerating the valve)
- YEfric** Friction correction (for bleeding the valve)

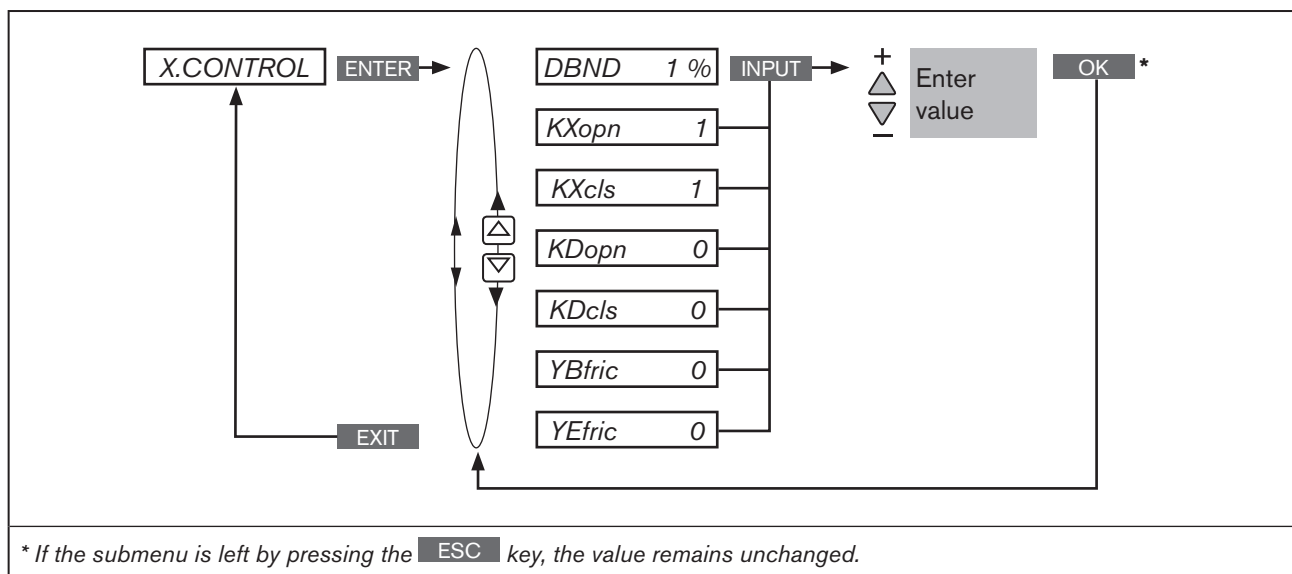


Figure 77: Operating structure X.CONTROL

DBND Insensitivity range (dead zone) of the positioner

Input the dead zone as %, relating to the scaled stroke range;
i.e. $X.LIMIT Max - X.LIMIT Min$ (see Auxiliary function [“25.2.6 X.LIMIT – Limits the mechanical stroke range”](#)).

This function causes the controller to respond only from a specific control difference; as a result the solenoid valves in the Type 8692/8693 and the pneumatic actuator are protected.

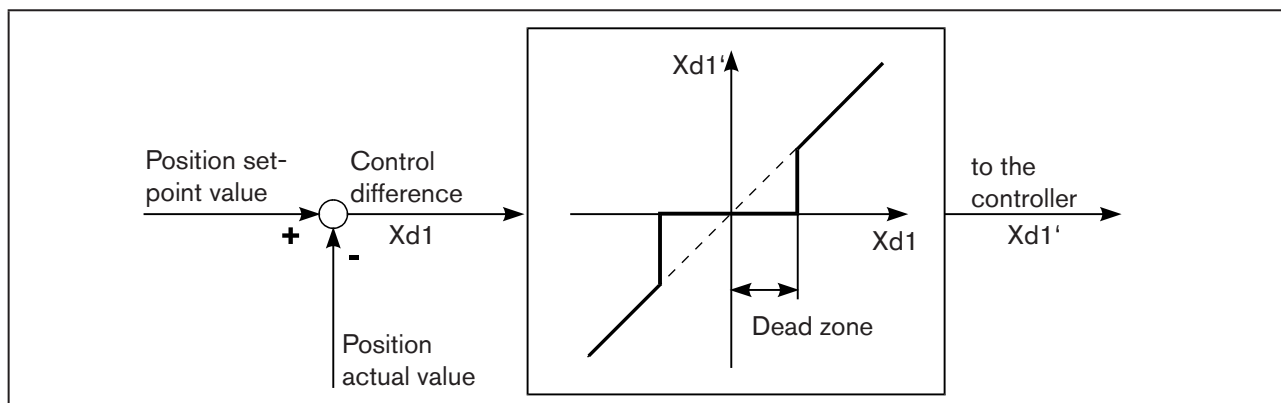


Figure 78: Graph - X.CONTROL

25.2.9 P.CONTROL – Setting up and parameterization of the process controller

Parameterization of the process controller is described in chapter [“24.1 P.CONTROL – Setting up and parameterization of the process controller”](#)

25.2.10 SECURITY – Code protection for the settings

Use the *SECURITY* function to prevent the Type 8692/8693 or individual functions from being accessed unintentionally.

Factory setting: Access Code: 0000

If the code protection is activated, the code (set access code or master code) must be input whenever operator action is disabled.

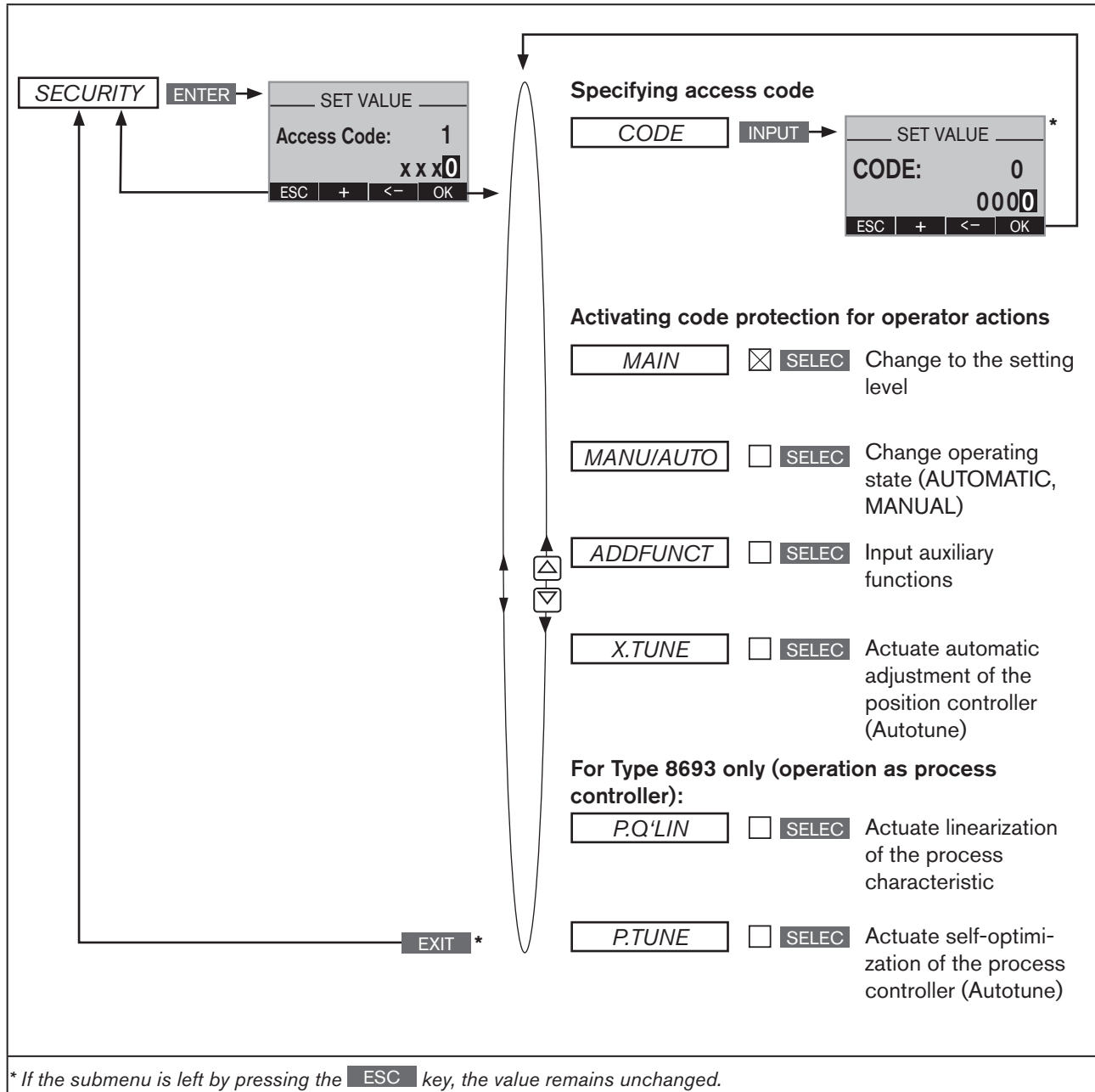


Figure 79: Operating structure SECURITY

Setting the code protection:
















Key	Action	Description
MENU	Press  for approx. 3 s	Switching from process level ⇔ setting level.
▲ / ▼	Select <i>SECURITY</i>	(To do this, the auxiliary function must be incorporated into the main menu).
ENTER	Press 	The input screen for the access code (<i>Access Code</i>) is displayed.
▲ / ▼	 Select decimal place  Increase number	Enter code. For the first setting: <i>Access Code</i> 0000 (factory settings) For activated code protection: <i>Access Code</i> from the user *
OK	Press 	The submenu of <i>SECURITY</i> is opened.
▲ / ▼	Select <i>CODE</i>	
INPUT	Press 	The input screen for specifying the access code (<i>Access Code</i>) is displayed.
▲ / ▼	 Select decimal place  Increase number	Enter required access code.
OK	Press 	Acknowledgment and return to the <i>SECURITY</i> menu.
▲ / ▼	select	Selector operator actions to which the code protection is to apply.
SELEC	Press 	Activate code protection by checking the box <input checked="" type="checkbox"/> .
EXIT	Press 	Acknowledgment and simultaneous return to the main menu (MAIN).
EXIT	Press 	Switching from setting level ⇔ process level.

Table 54: *SECURITY*; setting code protection

 The changed data is saved in the memory (EEPROM) only when there is a switch to the process level, by leaving the main menu (MAIN) using the left selection key **EXIT**. During the save process, the save symbol is indicated  on the display.

 * If you have forgotten the set code:
All operator actions can be implemented with the non-changeable master code. This 4-digit master code can be found in the printed brief instructions for Type 8692/8693.

25.2.11 SAFEPOS – Input the safety position

This function specifies the actuator safety position which is started at defined signals.



The set safety position is only started

- if there is a corresponding signal on the binary input
(Configuration see *chapter* “25.2.13 BINARY.IN – Activation of the binary input”) or
- if a signal fault occurs
(Configuration see *chapter* “25.2.12 SIG.ERROR – Configuration of signal level fault detection”).

In the case of the bus version (PROFIBUS DP / DeviceNet) the safety position is also started with

- corresponding parameter telegram
- *BUS ERROR* (adjustable)

If the mechanical stroke range is limited with the *X.LIMIT* function, only safety positions within these limits can be started.

This function is executed in *AUTOMATIC* mode only.

Factory setting: 0 %

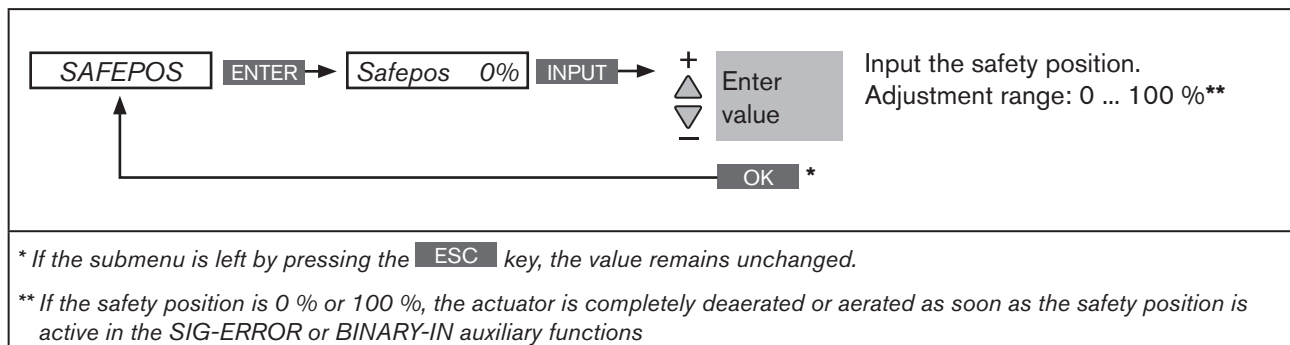



Figure 80: Operating structure SAFEPOS



The changed data is saved in the memory (EEPROM) only when there is a switch to the process level, by leaving the main menu (MAIN) using the left selection key **EXIT**. During the save process, the save symbol is indicated  on the display.

25.2.12 SIG.ERROR – Configuration of signal level fault detection

The *SIG-ERROR* function is used to detect a fault on the input signal.

If signal fault detection is activated, the respective fault is indicated on the display.
(See chapter “34.1 Error messages on the display”.)

A fault detection on the input signal is only possible for signal types 4 -20 mA and Pt 100.
The particular menu branch is hidden for other signal types.

- **4 - 20 mA:** Fault if input signal (≤ 3.5 mA (± 0.5 % of final value, hysteresis 0.5 % of final value))
- **Pt 100** (can be set for process controller Type 8693 only):
Fault if input signal 225 °C (± 0.5 % of final value, hysteresis 0.5 % of final value)



The signal type is set in the following menus:

1. *INPUT* (for Types 8692 and 8693):
See chapter “22.2 INPUT - Setting the input signal”.
2. *P.CONTROL* (for Type 8693 and when process controller activated):
See chapter “24.2.1 PV-INPUT – Specifying signal type for the process actual value”.

NOTE: The fault detection is only possible if the external set-point value default was selected in *SP-INPUT*. See chapter “24.2.3 SP-INPUT – Type of the set-point value default (internal or external)”.

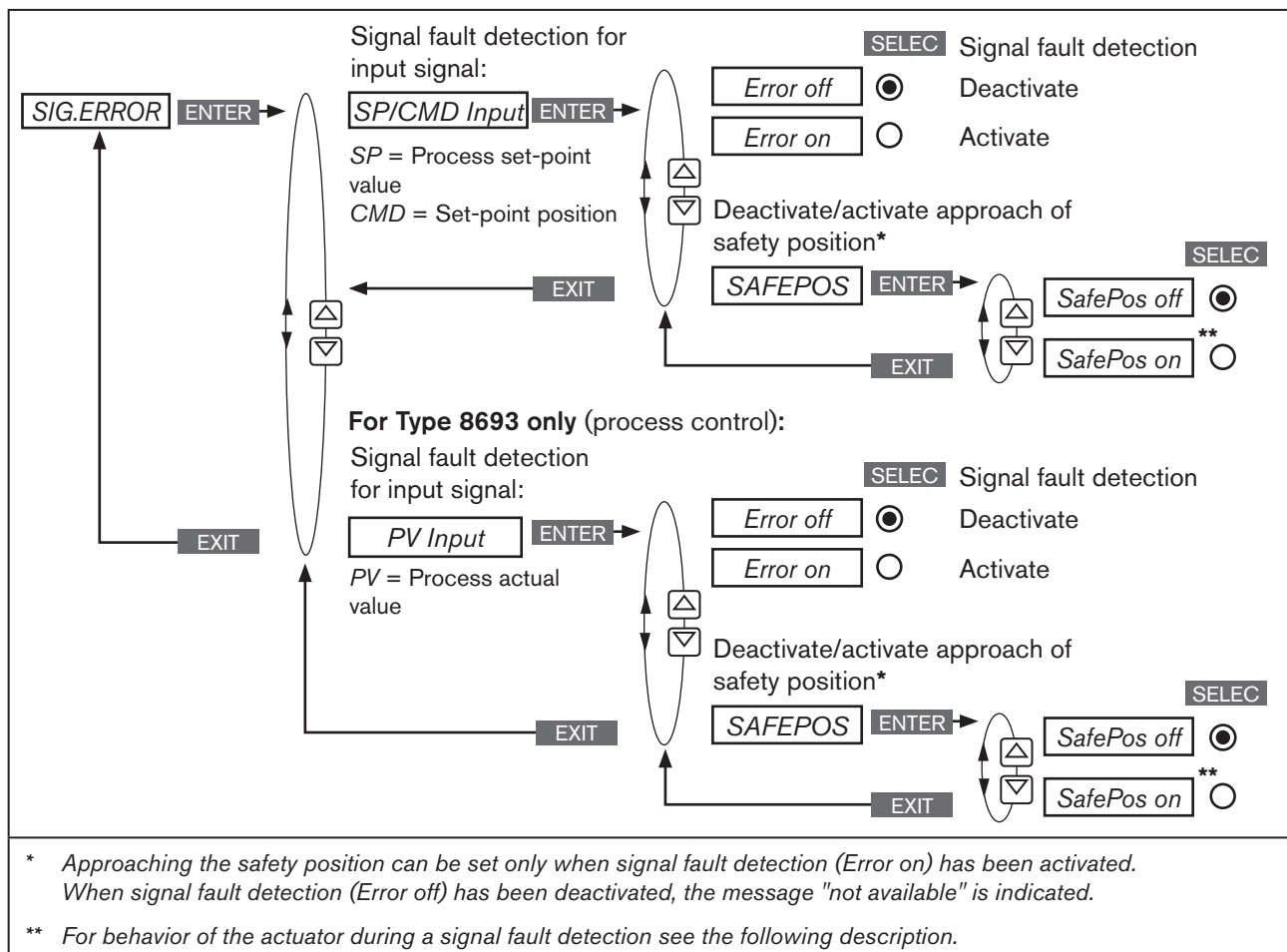


Figure 81: Operating structure SIG-ERROR

25.2.12.1. Behavior of the actuator when safety position deactivated or activated

Selection *SafePos off* – The actuator remains in the position which corresponds to the set-point value last transferred (default setting).

Selection *SafePos on* – Approaching the safety position activated:

In the event of a signal fault detection, the behavior of the actuator depends on the activation of the *SAFEPOS* auxiliary function. See chapter “25.2.11 *SAFEPOS* – Input the safety position”.

- *SAFEPOS* activated: In the event of a signal fault detection the actuator moves to the position which is specified in the *SAFEPOS* auxiliary function.
- *SAFEPOS* not activated: The actuator moves to the safety end position which it would assume if the electrical and pneumatic auxiliary power failed. See chapter “10.9 Safety end positions after failure of the electrical or pneumatic auxiliary power”.

! The activation for approaching the safety position (selection *SafePos on*) is possible only when signal fault detection has been activated (*ERROR on*).

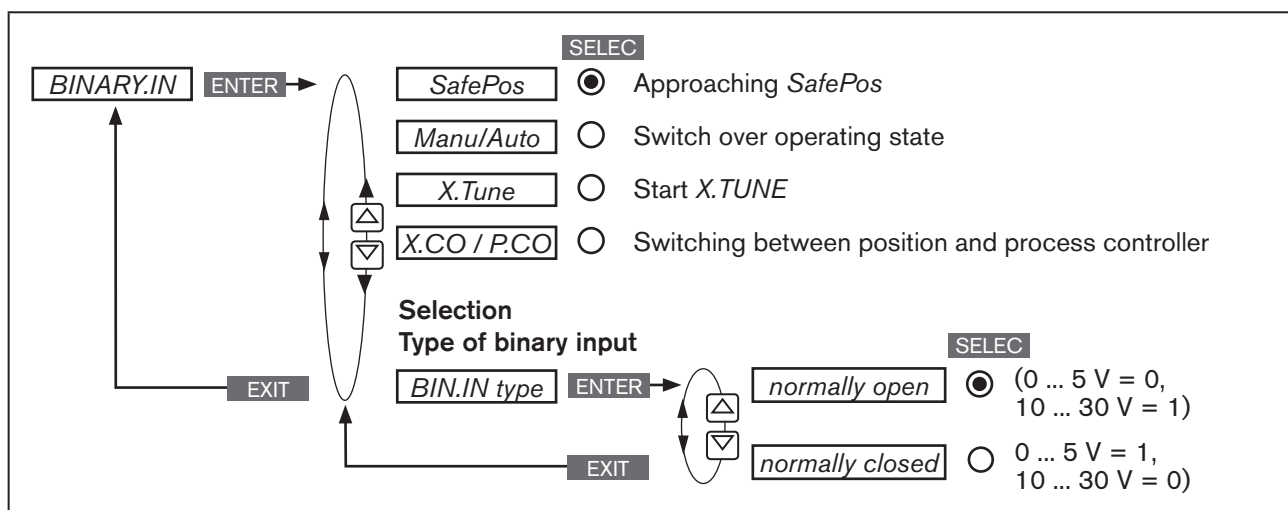
25.2.13 *BINARY.IN* – Activation of the binary input

The binary input is configured in this menu. The following functions can be assigned to it:

- SafePos* Approaching *SafePos*
- Manu/Auto* Switching over the operating state (MANUAL / AUTOMATIC)
- X.TUNE* Starting the function *X.TUNE*

Only for type 8693 and when process controller activated:

- X.CO/P.CO* Switching between position and process controller



SafePos – Approaching a safety position:

The behavior of the actuator depends on the activation of the *SAFEPOS* auxiliary function.
See chapter [“25.2.11 SAFEPOS – Input the safety position”](#).

SAFEPOS activated: The actuator moves to the safety position which is specified in the *SAFEPOS* auxiliary function.

SAFEPOS deactivated: The actuator moves to the safety end position which it would assume if the electrical and pneumatic auxiliary power failed.
See chapter [“10.9 Safety end positions after failure of the electrical or pneumatic auxiliary power”](#).

Binary input = 1 → Actuator moves to the set safety position.

Manu/Auto – Switching between the MANUAL and AUTOMATIC operating states:

Binary input = 0 → Operating state AUTOMATIC **AUTO**

Binary input = 1 → Operating state MANUAL **MANU**



If the *Manu/Auto* function was selected in the *BINARY.IN* menu, it is no longer possible to change the operating state on the process level using the keys **MANU** and **AUTO**.

X.TUNE – Starting the function X.TUNE:

Binary input = 1 → Starting *X.TUNE*

X.CO/P.CO – Switching between position and process controller:

This menu option stands only for Type 8693 and is available when process controller (*P.CONTROL*) has been activated.

Binary input = 0 → Position controller (*X.CO*)

Binäreingang = 1 → Process controller (*P.CO*)

25.2.14 OUTPUT – Configuring the outputs (option)

! The *OUTPUT* menu option is only indicated in the selection menu of *ADD.FUNCTION* if the Type 8692/8693 has outputs (option).

The Type 8692/8693 which has the outputs option is available in the following versions:

- one analogue output
- one analogue and two binary outputs
- two binary outputs

! According to the version of the Type 8692/8693 only the possible adjustable outputs (*ANALOGUE*, *ANALOGUE + BIN 1 + BIN 2* or *BIN 1 + BIN 2*) are indicated in the *OUTPUT* menu option.

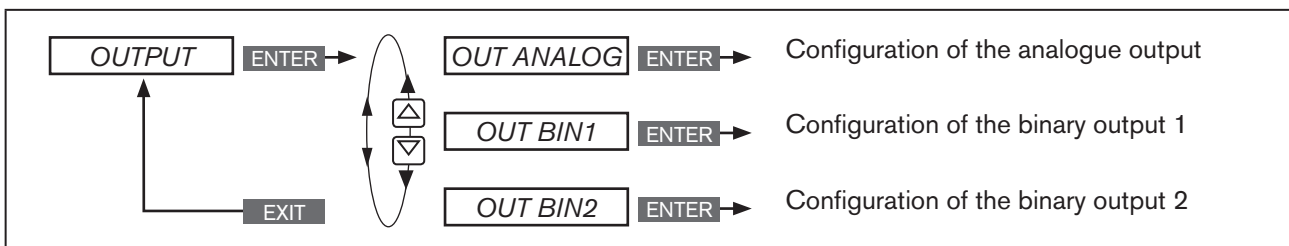
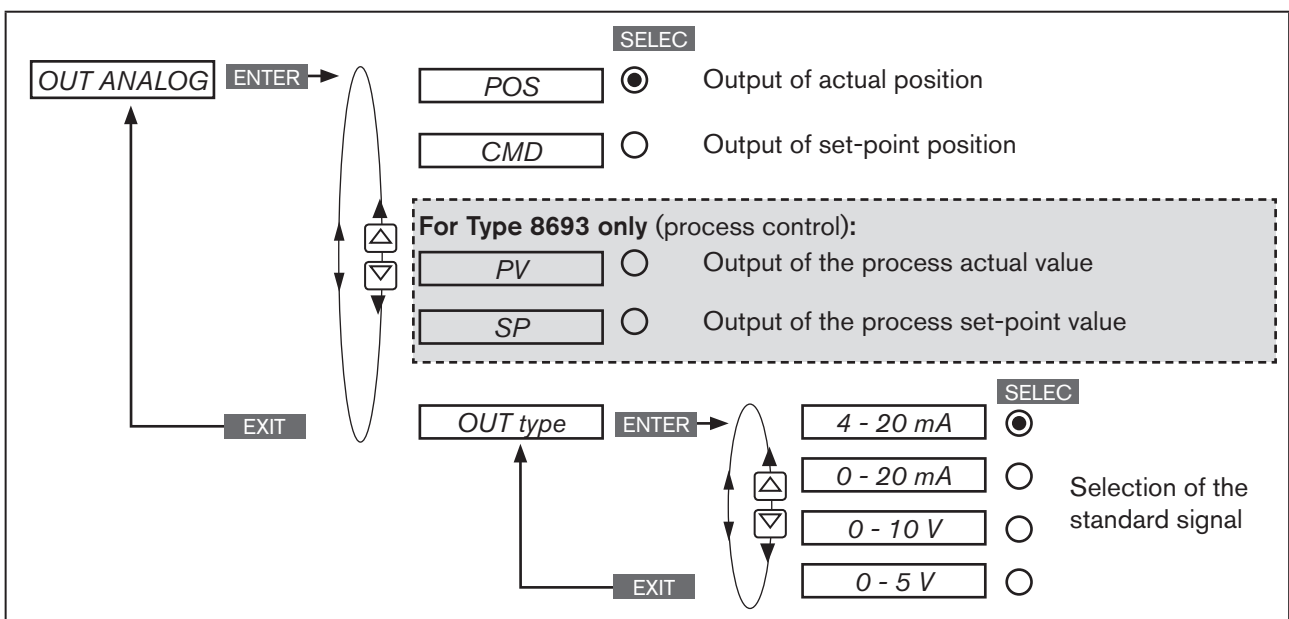


Figure 83: Operating structure OUTPUT;

25.2.14.1. OUT ANALOG - Configuring the analogue output

Type 8692: The feedback of the current position (*POS*) or of the set-point value (*CMD*) can be transmitted to the control center via the analog output.

Type 8693: The feedback of the current position (*POS*) or of the set-point value (*CMD*), of the process actual value (*PV*) or of the process set-point value (*SP*) can be transmitted to the control center via the analog output.



MAN 1000108626 EN Version: F Status: RL (released | freigegeben) printed: 20.01.2015

130 Figure 84: Operating structure OUTPUT-ANALOG;

25.2.14.2. OUT BIN1 / OUT BIN2 - Configuring the binary outputs

The following description is valid for both binary outputs *OUT BIN 1* and *OUT BIN 2*, as the operation in the menu is identical.

The binary outputs 1 and 2 can be used for one of the following outputs:

- POS.Dev Exceeding the permitted control deviation
- POS.Lim-1/2 Current position with respect to a specified limit position (> or <)
- Safepos Actuator in safety position
- ERR.SP/CMD Sensor break (SP = process set-point value / CMD = set-point value position)
- ERR.PV Sensor break (process actual value). **Available for Type 8693 only.**
- Remote Operating state (AUTOMATIC / MANUAL)
- Tune.Status Status *X.TUNE* (process optimization)
- DIAG.State-1/2 Diagnosis output (option)

Overview of possible outputs and associated switching signals:

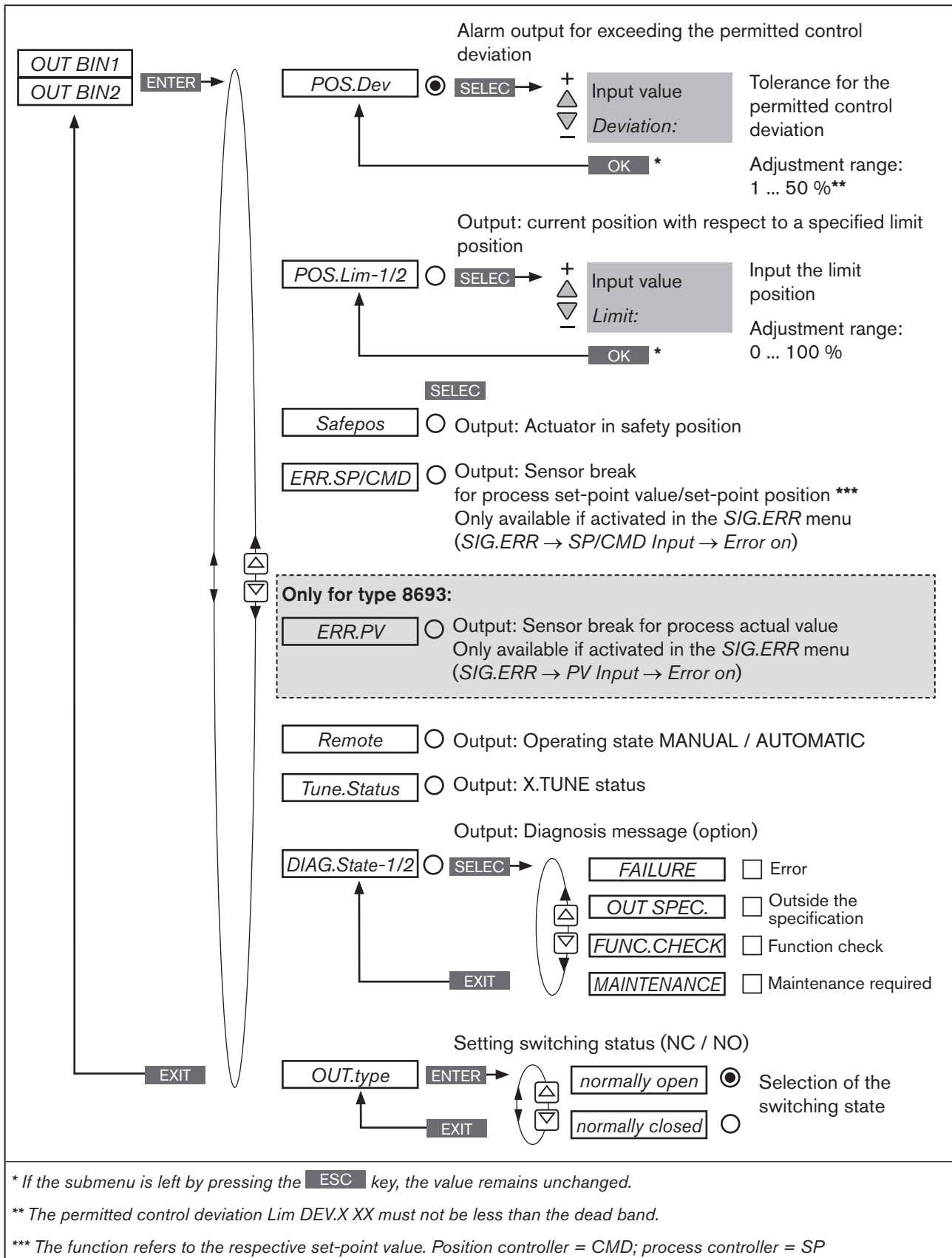
Menu option	Switching signal	Description
POS.Dev	0	Control deviation is within the set limit.
	1	Control deviation is outside the set limit.
POS.Lim-1/2	0	Actual position is above the limit position.
	1	Actual position is below the limit position.
Safepos	0	Actuator is not in the safety position.
	1	Actuator is in the safety position.
ERR.SP/CMD	0	No sensor break available.
ERR.PV	1	Sensor break available.
Remote	0	Appliance is the AUTOMATIC operating state.
	1	Appliance is the MANUAL operating state.
Tune.Status	0	The <i>X.TUNE</i> function is currently not running.
	1	The <i>X.TUNE</i> function is currently running.
	0/1 alternating (10 s)	The <i>X.TUNE</i> function was stopped during execution by a fault.
DIAG.State-1/2	0	No diagnosis message available for the selected status signals.
	1	Diagnosis message available for the selected status signals.

Table 55: OUT BIN 1/2; Possible outputs and associated switching signals

Switching signal	Switching statuses	
	normally open	normally closed
0	0 V	24 V
1	24 V	0 V

Table 56: OUT BIN 1/2; switching statuses

MAN 1000108626 EN Version: F Status: RL (released | freigegeben) printed: 20.01.2015



MAN 1000108626 EN Version: F Status: RL (released | freigegeben) printed: 20.01.2015

132 Figure 85: Operating structure OUTPUT-BIN1/BIN2

25.2.14.3. Setting of the submenu options of *OUT BIN 1 / OUT BIN 2*




Key	Action	Description
MENU	Press  for approx. 3 s	Switching from process level \Rightarrow setting level.
▲ / ▼	Select <i>OUTPUT</i>	(To do this, the auxiliary function must be incorporated into the main menu).
ENTER		The outputs are displayed.
▲ / ▼	Select <i>OUT BIN1/2</i>	
ENTER	Press 	Submenu options of <i>OUT BIN 1/2</i> are displayed.

Table 57: *OUT BIN1 / OUT BIN2; opening the submenu*

- *POS.Dev* - Alarm output for excessively large control deviation of the positioner
- *POS.Lim-1/2* - Output of the current position with respect to a specified limit position





Key	Action	Description
<i>POS.Dev</i> - Alarm output for excessively large control deviation of the positioner:		
▲ / ▼	Select <i>POS.Dev</i>	
SELEC	Press 	The input screen for the limit value (<i>Deviation:</i>) is opened.
▲ / ▼	+ Increase value - Reduce value	Input limit value for permitted control deviation. Adjustment range: 1 ... 50 % (must not be less than the dead band).
OK	Press 	Acknowledgment and simultaneous return to the <i>OUT BIN 1/2</i> menu. Then set the required switching status in the <i>OUT.type</i> submenu.
<i>POS.Lim-1/2</i> - Output of the current position with respect to a specified limit position:		
▲ / ▼	Select <i>POS.Lim-1/2</i>	
SELEC	Press 	The input screen for the limit position (<i>Limit:</i>) is opened.
▲ / ▼	+ Increase value - Reduce value	Input limit position. Adjustment range: 0 ... 100 %.
OK	Press 	Acknowledgment and simultaneous return to the <i>OUT BIN 1/2</i> menu. Then set the required switching status in the <i>OUT.type</i> submenu.

Table 58: *OUT BIN1 / OUT BIN2; setting value for POS.Dev or POS.Lim-1/2*

- **Safepos - Outputting the message: Actuator in safety position**
- **ERR.SP/CMD - Outputting the message: Sensor break for process set-point value/set-point position**
Only available if the function in the *SIG.ERR* menu has been activated (*SIG.ERR* → *SP/CMD input* → *Error on*).
See chapter “25.2.12 SIG.ERROR – Configuration of signal level fault detection”.
- **ERR.PV - Outputting the message: Sensor break for process actual value (only for Type 8693)**
Only available if the function in the *SIG.ERR* menu has been activated (*SIG.ERR* → *PV Input* → *Error on*).
See chapter “25.2.12 SIG.ERROR – Configuration of signal level fault detection”.
- **Remote - Output AUTOMATIC / MANUAL operating state**
- **Tune.Status - Output TUNE (process optimization)**


Key	Action	Description
▲ / ▼	Select submenu option	(<i>Safepos</i> , <i>ERR.SP/CMD</i> , <i>ERR.PV</i> , <i>Remote</i> or <i>Tune.Status</i>).
SELEC	Press 	Acknowledge submenu option as output function for the binary output. The selection is marked by a filled circle ●. Then set the required switching status in the <i>OUT.type</i> submenu.

Table 59: *OUT BIN1 / OUT BIN2; specifying Safepos, ERR.SP/CMD, ERR.PV, Remote or Tune.Status as output.*

- **DIAG.State-1/2 - Diagnosis output (option)**
Outputting the message: Diagnosis message from selected status signal
For description see chapter “25.2.21 DIAGNOSE – Menu for monitoring valves (option)”.




Key	Action	Description
▲ / ▼	Select <i>DIAG.State-1/2</i>	
SELEC	Press 	The status signals, which can be activated for outputting the message, are displayed.
▲ / ▼	Select status signal	Select the status signal which is to be assigned to the diagnosis output.
SELEC	Press 	Activate the selection by checking the box <input checked="" type="checkbox"/> or deactivate it by unchecking the box <input type="checkbox"/> .
		If required, activate further status signals for the diagnosis output by pressing the ▲ / ▼ and SELEC keys.
EXIT	Press 	Acknowledgment and simultaneous return to the <i>OUT BIN 1/2</i> menu. Then set the required switching status in the <i>OUT.type</i> submenu.

Table 60: *OUT.type; inputting switching status for binary output and return to the process level.*

▪ *OUT.type* - Setting the switching status

In addition to selecting the output, the switching status required for the binary output must be input. See "Table 62".









Key	Action	Description
▲ / ▼	Select <i>OUT.type</i>	
SELEC	Press 	The switching statuses <i>normally open</i> and <i>normally closed</i> are displayed.
▲ / ▼	Select switching status	
SELEC	Press 	The selection is marked by a filled circle ●.
EXIT	Press 	Acknowledgment and simultaneous return to the <i>OUT BIN 1/2</i> menu.
EXIT	Press 	Acknowledgment and simultaneous return to the <i>OUTPUT</i> menu.
EXIT	Press 	Acknowledgment and simultaneous return to the main menu (MAIN).
EXIT	Press 	Switching from setting level ⇌ process level.

Table 61: *OUT.type*; inputting switching status for binary output and return to the process level.

Switching signal	Switching statuses	
	normally open	normally closed
0	0 V	24 V
1	24 V	0 V

Table 62: *OUT BIN 1/2*; switching statuses

 The changed data is saved in the memory (EEPROM) only when there is a switch to the process level, by leaving the main menu (MAIN) using the left selection key **EXIT**. During the save process, the save symbol  on the display.

25.2.15 CAL.USER – Calibration of actual value and set-point value

The following values can be manually calibrated with this function:

- Position actual value **calibr. POS** (0 - 100 %)
- Position set-point value **calibr. INP** (4 - 20 mA, 0 - 20 mA, 0 - 5 V, 0 - 10 V)
For the calibration process the signal type is displayed which was specified for the input signal.
See chapter [“22.2 INPUT - Setting the input signal”](#).

Type 8693:

The following values can be calibrated only for Type 8693 and activated process controller (*P.CONTROL*).

- Process set-point value **calibr. SP** (4 - 20 mA, 0 - 20 mA, 0 - 5 V, 0 - 10 V)
For the calibration process the signal type is displayed which was specified for the input signal.
See chapter [“22.2 INPUT - Setting the input signal”](#).



The calibration of the process set-point value is only possible if the external set-point value default was selected when setting up the process controller.

See chapter [“24.2.3 SP-INPUT – Type of the set-point value default \(internal or external\)”](#).

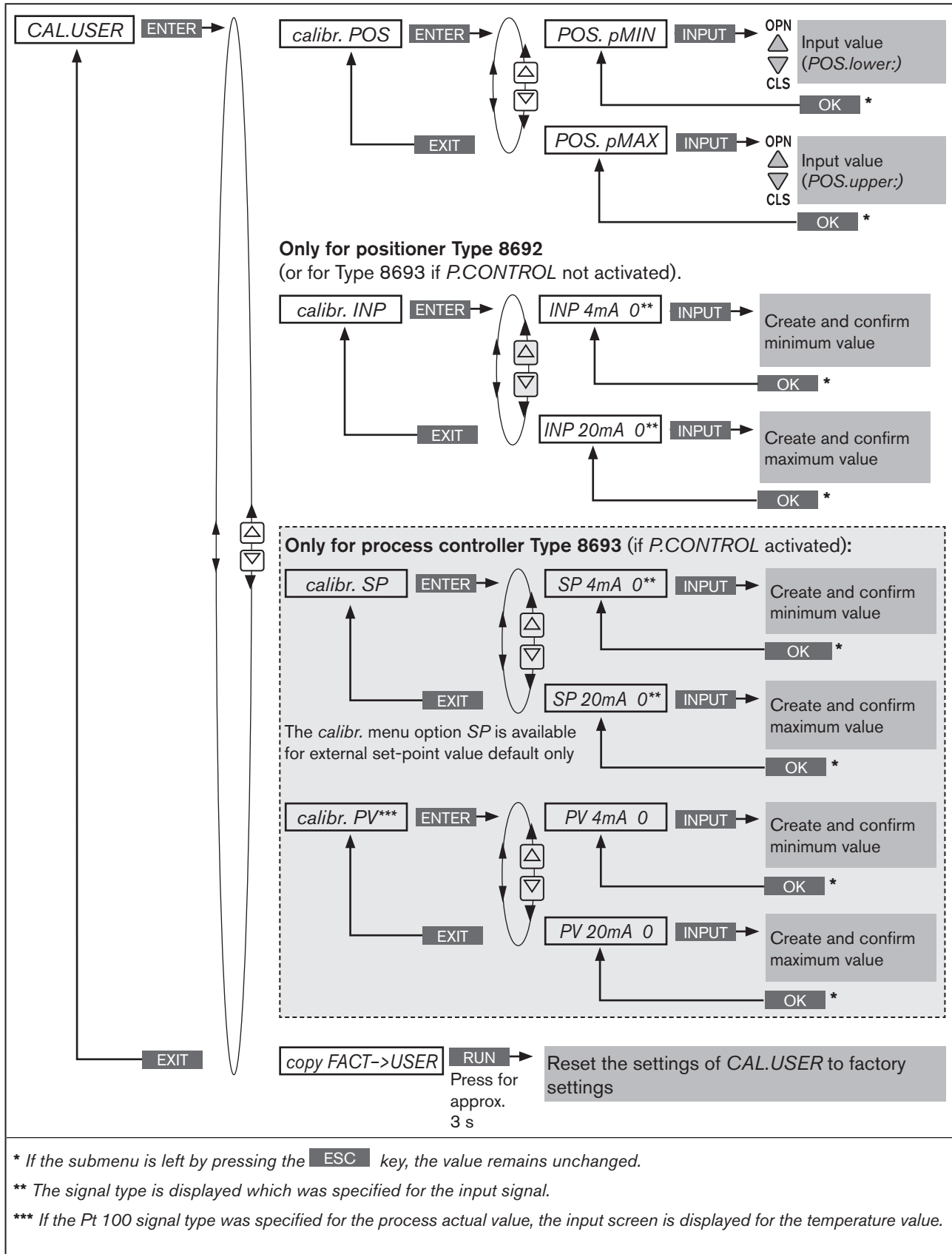
Setting: *P.CONTROL* → *SETUP* → *SP-INPUT* → *extern*

- Process actual value **calibr. PV** (4 - 20 mA or °C)
For the calibration process the signal type is displayed which was specified for the process actual value when setting up the process controller.
See chapter [“24.2.1 PV-INPUT – Specifying signal type for the process actual value”](#)



The frequency signal type (flow rate) cannot be calibrated.

If the frequency was set when setting up the process controller (*P.CONTROL* → *SETUP* → *PV-INPUT* → *Frequenz*), the *calibr. PV* menu option is hidden.



MAN 1000108626 EN Version: F Status: RL (released | freigegeben) printed: 20.01.2015

Figure 86: Operating structure *CAL.USER*

25.2.15.1. Calibration of the position actual value and the position set-point value















Key	Action	Description
MENU	Press  for approx. 3 s	Switching from process level \Rightarrow setting level.
▲ / ▼	Select <i>CAL.USER</i>	(To do this, the auxiliary function must be incorporated into the main menu).
ENTER		The submenu options are displayed.
<i>calibr. POS</i> - Calibration of the position actual value (0 - 100 %):		
▲ / ▼	Select <i>calibr.POS</i>	
ENTER	Press 	The menu options for the minimum and the maximum position actual values are displayed.
▲ / ▼	Select <i>POS. pMin</i>	
INPUT	Press 	The input screen for the lower value (<i>POS.lower</i>) is opened.
▲ / ▼	OPN Open more CLS Close more	Approach minimum position of the valve.
OK	Press 	Transfer and simultaneous return to the <i>calibr.POS</i> menu.
▲ / ▼	Select <i>POS. pMax</i>	
INPUT	Press 	The input screen for the upper value (<i>POS.upper</i>) is opened.
▲ / ▼	OPN Open more CLS Close more	Approach maximum position of the valve.
OK	Press 	Transfer and simultaneous return to the <i>calibr.POS</i> menu.
EXIT	Press 	Acknowledgment and simultaneous return to the <i>CAL.USER</i> menu.
<i>calibr. INP</i> calibration of the position set-point value (4 ... 20 mA; 0 ... 20 mA; 0 ... 5 V, 0 ... 10 V):		
▲ / ▼	Select <i>calibr.INP</i>	
ENTER	Press 	The menu options for the minimum and maximum value of the input signal are displayed.
▲ / ▼	Select <i>INP 0mA (4mA/0V)</i>	The minimum value for the input signal is displayed.
-	-	Apply the minimum value to the input.
OK	Press 	Transfer and simultaneous return to the <i>calibr.INP</i> menu.
▲ / ▼	Select <i>INP 20mA (5V/10V)</i>	The maximum value for the input signal is displayed.
-	-	Apply the maximum value to the input.
OK	Press 	Transfer and simultaneous return to the <i>calibr.INP</i> menu.
EXIT	Press 	Acknowledgment and simultaneous return to the <i>CAL.USER</i> menu.
EXIT	Press 	Acknowledgment and simultaneous return to the main menu (MAIN).
EXIT	Press 	Switching from setting level \Rightarrow process level.

Table 63: *CAL.USER*; calibration of position actual value and position set-point value

25.2.15.2. Calibration of the process set-point value and process actual value















Key	Action	Description
MENU	Press  for approx. 3 s	Switching from process level \Rightarrow setting level.
▲ / ▼	Select <i>CAL.USER</i>	(To do this, the auxiliary function must be incorporated into the main menu).
ENTER		The submenu options are displayed.
<i>calibr. SP</i> - calibration of the process set-point value:		
▲ / ▼	Select <i>calibr.SP</i>	
ENTER	Press 	The menu options for the minimum and the maximum process set-point values are displayed.
▲ / ▼	Select <i>SP 0mA (4mA/0V)</i>	The minimum value for the input signal is displayed.
-	-	Apply the minimum value to the input.
OK	Press 	Transfer and simultaneous return to the <i>calibr.SP</i> menu.
▲ / ▼	Select <i>SP 20mA (5V/10V)</i>	The maximum value for the input signal is displayed.
-	-	Apply the maximum value to the input.
OK	Press 	Transfer and simultaneous return to the <i>calibr.SP</i> menu.
EXIT	Press 	Acknowledgment and simultaneous return to the <i>CAL.USER</i> menu.
<i>calibr. PV</i> - calibration of the process actual value for input signal 4 - 20 mA:		
▲ / ▼	Select <i>calibr.PV</i>	
ENTER	Press 	The menu options for the minimum and the maximum process actual values are displayed.
▲ / ▼	Select <i>PV 4mA</i>	The minimum value for the input signal is displayed.
-	-	Apply the minimum value to the input.
OK	Press 	Transfer and simultaneous return to the <i>calibr.PV</i> menu.
▲ / ▼	Select <i>PV 20mA</i>	The maximum value for the input signal is displayed.
-	-	Apply the maximum value to the input.
OK	Press 	Transfer and simultaneous return to the <i>calibr.PV</i> menu.
EXIT	Press 	Acknowledgment and simultaneous return to the <i>CAL.USER</i> menu.
<i>calibr. PV</i> - calibration of the process actual value for input signal Pt 100:		
▲ / ▼	Select <i>calibr.PV</i>	
ENTER	Press 	The input screen for calibration of the temperature is opened.
▲ / ▼	<- Select decimal place + Increase number	Input the current temperature.
OK	Press 	Transfer and simultaneous return to the <i>CAL.USER</i> menu.
EXIT	Press 	Acknowledgment and simultaneous return to the main menu (MAIN).
EXIT	Press 	Switching from setting level \Rightarrow process level.

Table 64: *CAL.USER*; calibration of position actual value and position set-point value

25.2.15.3. Resetting the settings under *CAL.USER* to the factory settings






Key	Action	Description
MENU	Press  for approx. 3 s	Switching from process level \Rightarrow setting level.
▲ / ▼	Select <i>CAL.USER</i>	(To do this, the auxiliary function must be incorporated into the main menu).
ENTER		The submenu options are displayed.
▲ / ▼	Select <i>copy FACT->USER</i>	
RUN	 Hold down as long as countdown (5 ...) is running	The settings of <i>CAL.USER</i> are reset to the factory settings.
EXIT	Press 	Acknowledgment and simultaneous return to the main menu (MAIN).
EXIT	Press 	Switching from setting level \Rightarrow process level.

Table 65: *copy FACT->USER; resetting the settings under CAL.USER to the factory settings*



The factory calibration is re-activated by deactivating *CAL.USER*, by removing the auxiliary function from the main menu (**MAIN**).

25.2.16 SET.FACTORY – Resetting to the factory settings

This function allows all settings implemented by the user to be reset to the delivery status.

All EEPROM parameters with the exception of the calibration values are reset to default values. Then a hardware reset is implemented.

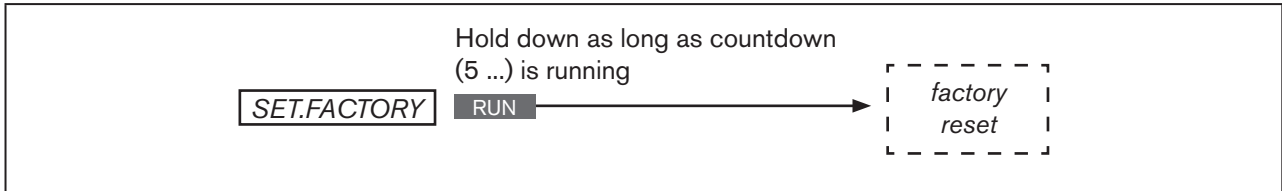


Figure 87: Operating structure SET.FACTORY

Resetting to the factory settings:

Key	Action	Description
MENU	Press for approx. 3 s	Switching from process level ⇒ setting level.
▲ / ▼	Select SET.FACTORY	(To do this, the auxiliary function must be incorporated into the main menu).
RUN	Press for approx. 3 s (until progress bar is closed)	"factory reset" is shown. Reset is implemented.
EXIT	Press	Switching from setting level ⇒ process level.

Table 66: SET.FACTORY; Resetting to the factory settings



To adjust the Type 8692/8693 to the operating parameters, re-implement self-parameterization of the positioner (X.TUNE).

25.2.17 SER. I/O – Settings of the serial interface

This function can be used to set the type of the serial interface and the baud rate.

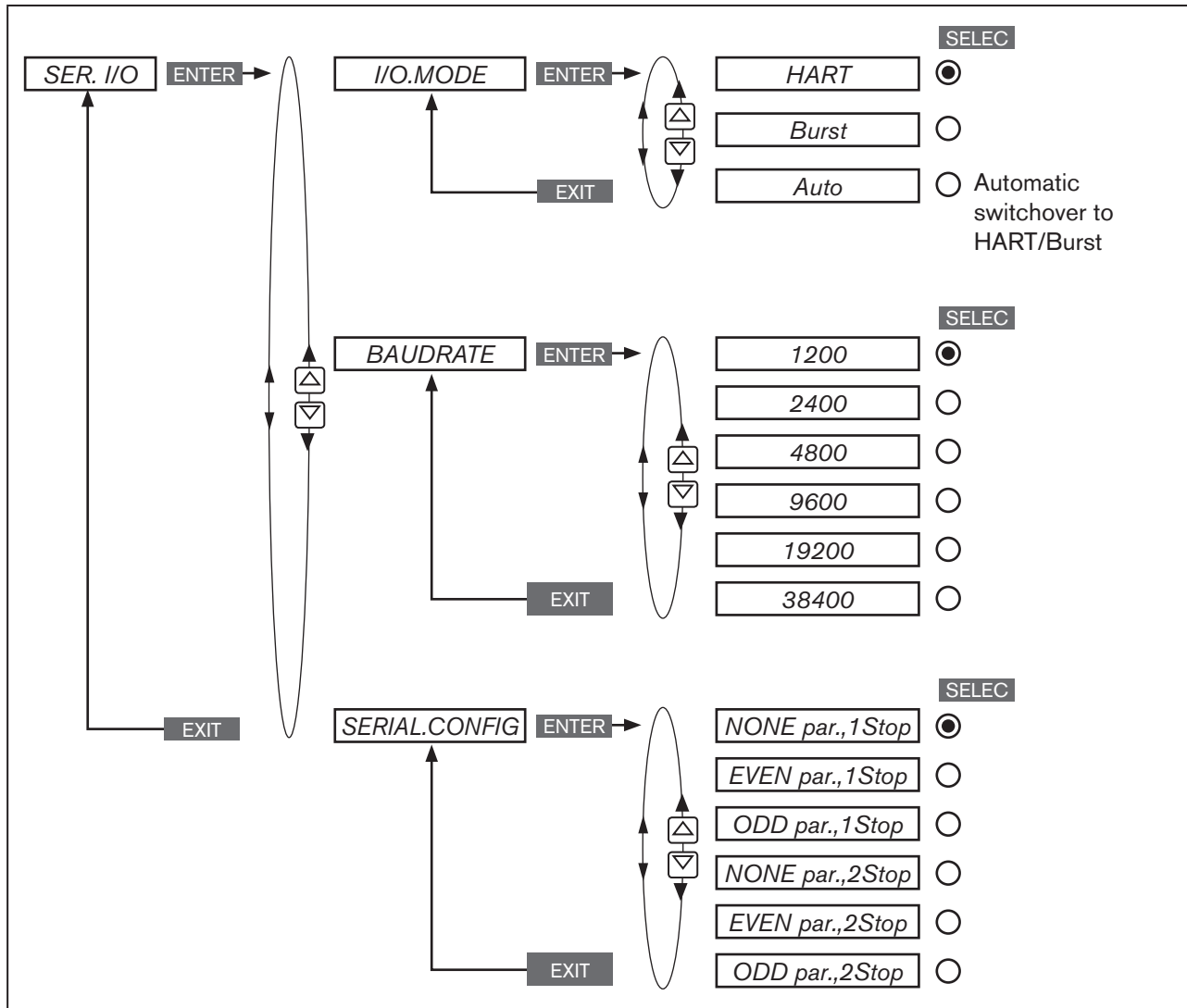


Figure 88: Operating structure SER. I/O

25.2.18 EXTRAS – Setting the display

This function can be used to individually set the display.

- In *DISP.ITEMS* the display of the process level can be individually set.
To do this, further menu options can be activated for the display of the process level. *POS* and *CMD* are activated in the as-delivered state.
- In *START-UP.ITEM* one of the activated menu options is specified as a start display after a restart.
- The type of display is selected via *DISP.MODE*.
normal = black font on light background.
inverse = white font on dark background.
- *DISP.LIGHT* is used to define the background lighting of the display.
on = Background lighting on.
off = Background lighting off.
user active = Background lighting switches off after 10 seconds with no user interaction. If a key is pressed again, the background lighting goes on again.

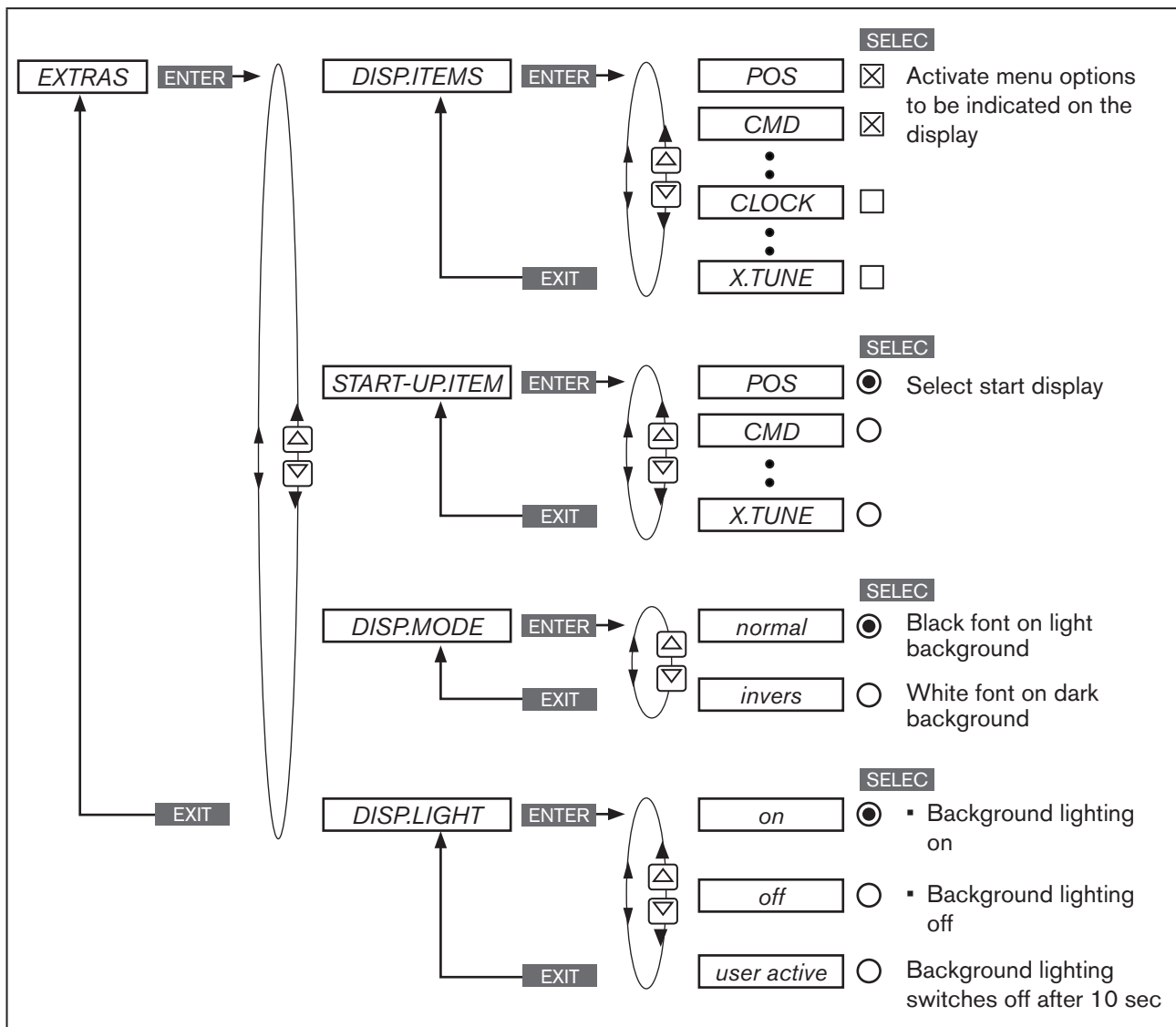


Figure 89: Operating structure EXTRAS

DISP.ITEMS - Activating menu displays for displaying the process level:











Key	Action	Description
MENU	Press  for approx. 3 s	Switching from process level ⇔ setting level.
▲ / ▼	Select <i>ADD.FUNCTION</i>	
ENTER	Press 	The possible auxiliary functions are displayed.
▲ / ▼	Select <i>EXTRAS</i>	
ENTER	Press 	Activate the <i>EXTRAS</i> auxiliary function by checking the box <input checked="" type="checkbox"/> and transfer into the main menu.
EXIT	Press 	Return to the main menu (MAIN).
▲ / ▼	Select <i>EXTRAS</i>	
ENTER	Press 	The submenus of <i>EXTRAS</i> are displayed.
▲ / ▼	Select <i>DISP.ITEMS</i>	
ENTER	Press 	The possible menu options are displayed. <i>POS, CMD, CMDIPOS, CMD/POS(t), CLOCK, INPUT, TEMP, X.TUNE.</i> <i>Additionally for process controller Type 8693: PV, SP, SPIPV, SP/PV(t), P.TUNE, P.LIN.</i>
▲ / ▼	Select required menu options	
SELEC	Press 	Activate the selection by checking the box <input checked="" type="checkbox"/> or deactivate it by unchecking the box <input type="checkbox"/> .
EXIT	Press 	Return to the <i>EXTRAS</i> menu.
EXIT	Press 	Return to the main menu (MAIN).
EXIT	Press 	Switching from setting level ⇔ process level.

Table 67: *DISP.ITEMS*; activating menu options to be displayed on the process level

The activated menu options are now displayed on the process level display.

Use the arrow keys ▲ ▼ to switch between the displays.



Each menu option which can be selected can also be deactivated so that it is not indicated on the process level display. However, there must be at least one menu option available which can be indicated on the display. If nothing was selected, the *POS* menu option is automatically activated.

START-UP.ITEM - Specifying menu option for the start display:

EXTRAS → **START-UP.ITEM** ▲ / ▼ Select menu option and specify with **SELEC**.

The menu option for the start display is marked by the filled circle ●.

The detailed procedure can be found in the extensive menu description for *DISP.ITEMS* (see "Table 67"). The *START-UP.ITEM* and *DISP.ITEMS* menus are set in the same way.

DISP.MODE - Select type of display

(black font on light background or white font on dark background):













Key	Action	Description
MENU	Press  for approx. 3 s	Switching from process level \Rightarrow setting level.
▲ / ▼	Select <i>ADD.FUNCTION</i>	
ENTER	Press 	The possible auxiliary functions are displayed.
▲ / ▼	Select <i>EXTRAS</i>	
ENTER	Press 	Activate the <i>EXTRAS</i> auxiliary function by checking the box <input type="checkbox"/> and transfer into the main menu.
EXIT	Press 	Return to the main menu (MAIN).
▲ / ▼	Select <i>EXTRAS</i>	
ENTER	Press 	The submenus of <i>EXTRAS</i> are displayed.
▲ / ▼	Select <i>DISP.MODE</i>	
ENTER	Press 	The possible menu options for the type of display are shown. <i>normal</i> = black font on light background <i>inverse</i> = white font on dark background
▲ / ▼	Select the type of display	
SELEC	Press 	The selection is marked by a filled circle  .
EXIT	Press 	Return to the <i>EXTRAS</i> menu.
EXIT	Press 	Return to the main menu (MAIN).
EXIT	Press 	Switching from setting level \Rightarrow process level.

Table 68: *DISP.MODE; Select type of display***DISP.LIGHT - Define background lighting for display:**

EXTRAS → **DISP.LIGHT** ▲ / ▼ Select background lighting and define with **SELEC**.

The menu option for the background lighting is marked by the filled circle .

- *on* = Background lighting on.
- *off* = Background lighting off.
- *user active* = Background lighting switches off after 10 seconds with no user interaction. If a key is pressed again, the background lighting goes on again.

The detailed procedure can be found in the extensive menu description for *DISP.MODE* (see "Table 68"). The *DISP.LIGHT* and *DISP.MODE* menus are set in the same way.

25.2.19 SERVICE

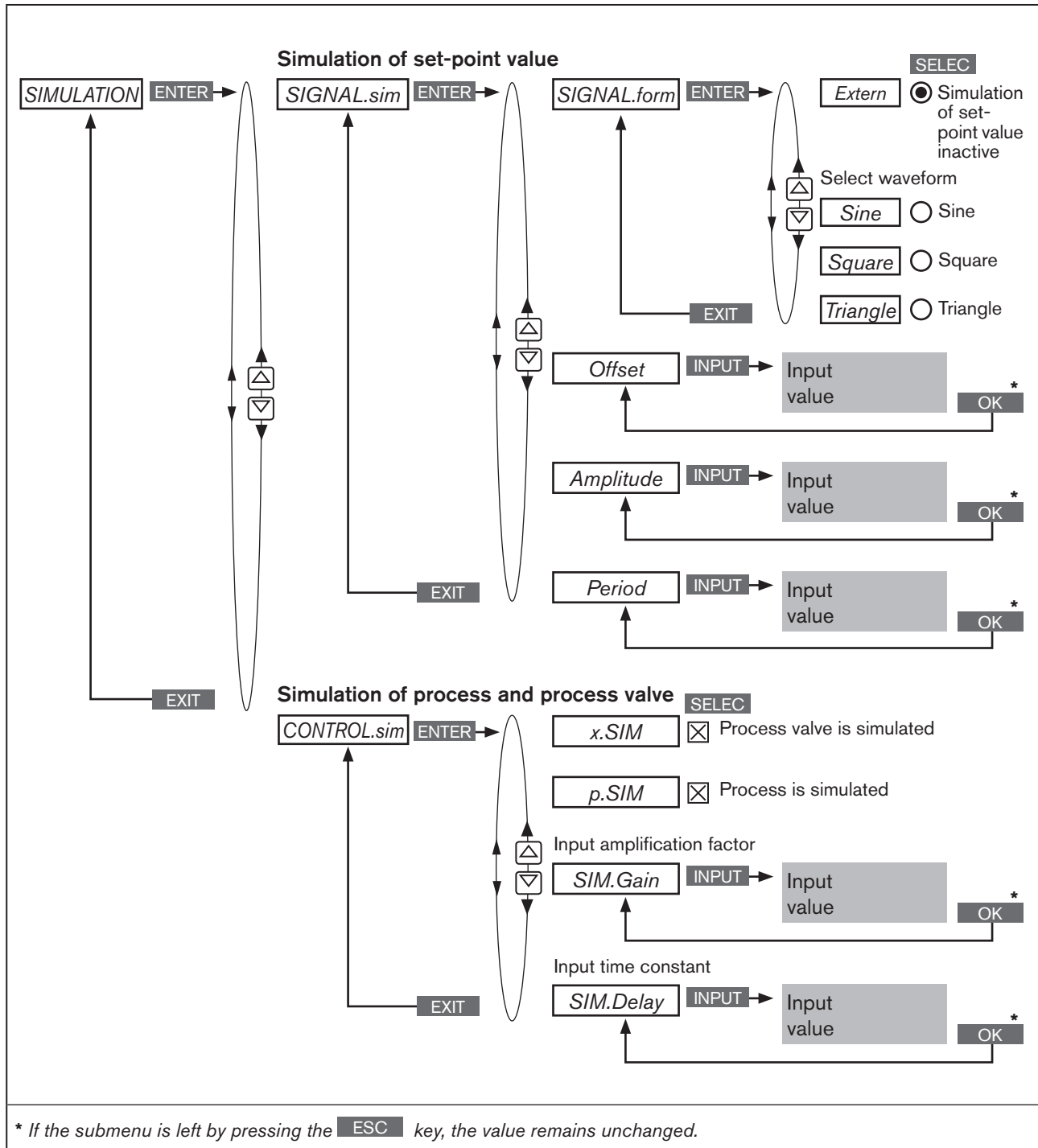
This function is of no importance to the operator of Type 8692/8693. It is for internal use only.

25.2.20 SIMULATION – Menu for simulation of set-point value, process and process valve

This function can be used to simulate set-point value, process and process valve independently of each other.



Caution! Restarting the device deactivates the simulation.
The settings of *SIGNAL.form*, *x.SIM* and *p.SIM* are reset to the factory setting.






MAN 1000108626 EN Version: F Status: RL (released | freigegeben) printed: 20.01.2015

25.2.20.1. SIGNAL.sim – Simulation of the set-point value

The settings to simulate the set-point value are made in the *SIGNAL.sim* menu.

Activation of the simulation: In the *SIGNAL.form* submenu by selecting one of the following waveforms

<i>Sine</i>	Sine wave	
<i>Square</i>	Square wave	
<i>Triangle</i>	Triangle wave	
<i>Mixed</i>	Single cycle of an alternating signal sequence. Then the selection is set to <i>Extern</i> (set-point value simulation inactive).	

The following parameters can be set for the selected waveform.

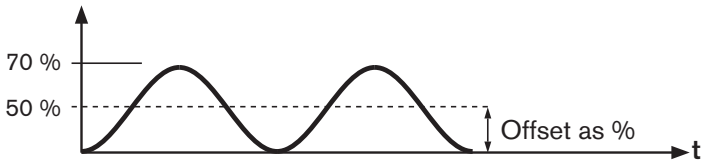
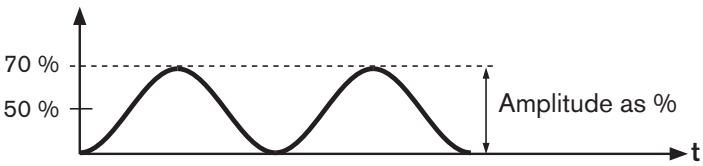
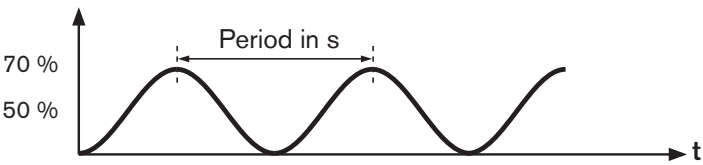


Menu option	Parameter setting	Schematic representation with sine wave
<i>Offset</i>	(Zero offset as %)	
<i>Amplitude</i>	(Amplitude as %)	
<i>Periode</i>	(Cycle duration in s)	

Table 69: *SIGNAL.sim*; parameter settings for set-point value simulation

Deactivation of the simulation: In the *SIGNAL.form* submenu

Selection *Extern* = set-point value simulation inactive
(corresponds to the factory setting in the as-delivered state)

Activating and parameterizing the set-point value simulation:

Key	Action	Description
MENU	Press  for approx. 3 s	Switching from process level \Rightarrow setting level.
▲ / ▼	Select <i>SIMULATION</i>	(To do this, the auxiliary function must be incorporated into the main menu).
ENTER	Press 	The submenu for setting the simulation is displayed.














Key	Action	Description
▲ / ▼	Select <i>SIGNAL.sim</i>	
ENTER	Press 	The submenu for activating and parameterizing the set-point value simulation is displayed.
▲ / ▼	Select <i>SIGNAL.form</i>	
ENTER	Press 	The menu options for activating and for selecting the waveform are displayed.
▲ / ▼	Select required menu option	Selection <input type="text" value="Extern"/> = simulation inactive. Selection <input type="text" value="Sine"/> / <input type="text" value="Square"/> / <input type="text" value="Triangle"/> / <input type="text" value="Mixed"/> = specify the waveform as well as activation of the simulation.
SELEC	Press 	The selection is marked by a filled circle ●.
EXIT	Press 	Return to the <i>SIGNAL.sim</i> menu.
Setting the parameters for simulation of the set-point value:		
▲ / ▼	Select <i>Offset</i>	(Zero offset as %).
INPUT	Press 	The input screen for specifying the offset is opened.
▲ / ▼	<input type="button" value="+"/> Increase value <input type="button" value="<-"/> Select decimal place	Input value.
OK	Press 	Transfer and simultaneous return to the <i>SIGNAL.sim</i> menu.
▲ / ▼	Select <i>Amplitude</i>	(Amplitude as %).
INPUT	Press 	The input screen for specifying the amplitude is opened.
▲ / ▼	<input type="button" value="+"/> Increase value <input type="button" value="<-"/> Select decimal place	Input value.
OK	Press 	Transfer and simultaneous return to the <i>SIGNAL.sim</i> menu.
▲ / ▼	Select <i>Period</i>	(Cycle duration in seconds).
INPUT	Press 	The input screen for specifying the cycle duration is opened.
▲ / ▼	<input type="button" value="+"/> Increase value <input type="button" value="<-"/> Select decimal place	Input value.
OK	Press 	Transfer and simultaneous return to the <i>SIGNAL.sim</i> menu.
EXIT	Press 	Return to the <i>SIMULATION</i> menu.
For simulation of process and process valve:		
▲ / ▼	Select <i>CONTROL.sim</i>	For description see chapter " 25.2.20.2. CONTROL.sim – Simulation of the process and process valve ".
Leaving the <i>SIMULATION</i> menu:		
EXIT	Press 	Return to the main menu (MAIN).
EXIT	Press 	Switching from setting level ⇨ process level.

Table 70: *SIGNAL.sim*; activating and parameterizing the set-point value simulation.

25.2.20.2. CONTROL.sim – Simulation of the process and process valve

The settings to simulate the process and the process valve are made in the *CONTROL.sim* menu.

Settings

- Type of simulation: *x.SIM* Simulation of the process valve.
 p.SIM Simulation of the process.
- Parameterization of the process: *SIM.Gain* Specify amplification factor.
 SIM.Delay Specify time constant in seconds.

Example of a simulated process:

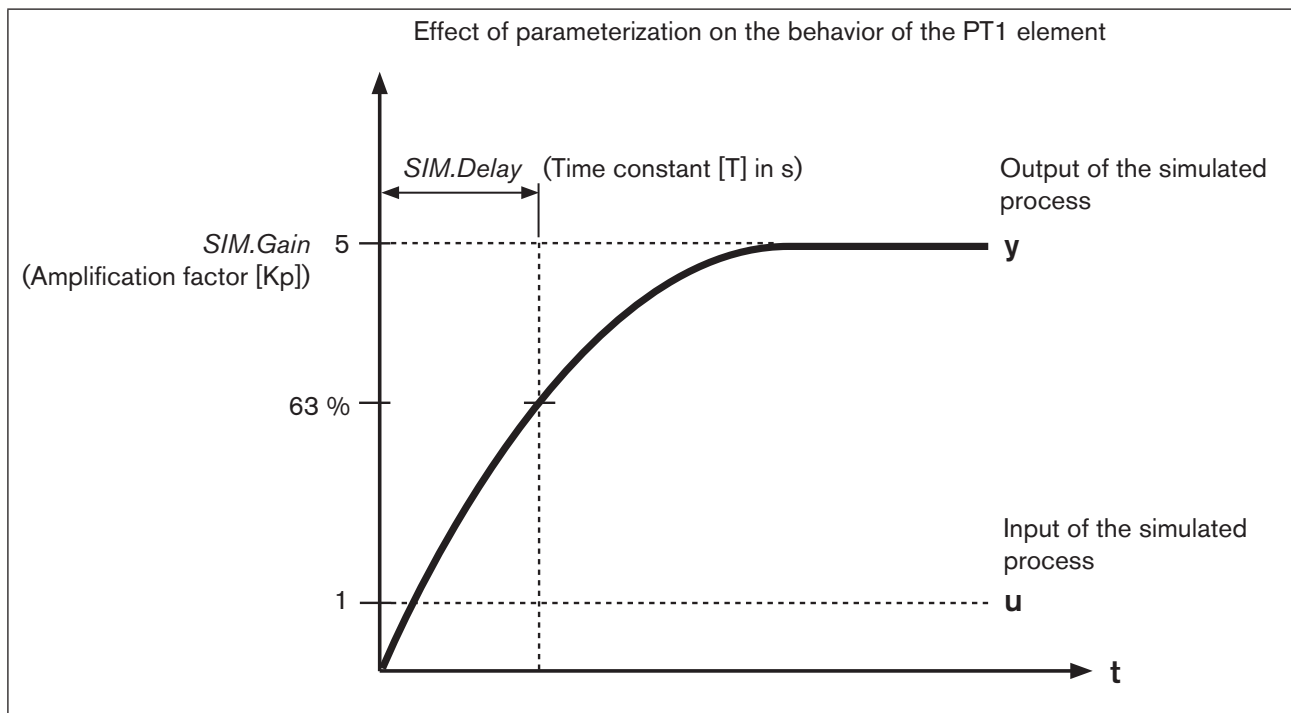





Figure 91: Example of a simulated process. Behavior of the PT1 element

Activating and parameterizing simulation of the process and/or process valve:

Key	Action	Description
MENU	Press  for approx. 3 s	Switching from process level \Rightarrow setting level.
▲ / ▼	Select <i>SIMULATION</i>	(To do this, the auxiliary function must be incorporated into the main menu).
ENTER	Press 	The submenu for setting the simulation is displayed.
▲ / ▼	Select <i>CONTROL.sim</i>	
ENTER	Press 	The submenu for activating and parameterizing the process and process valve simulation is displayed.









Key	Action	Description
▲ / ▼	Select required simulation	Selection <input type="checkbox"/> <i>x.SIM</i> = simulation process. Selection <input type="checkbox"/> <i>p.SIM</i> = simulation process valve.
SELEC	Press 	Activate the selection by checking the box <input checked="" type="checkbox"/> or deactivate it by unchecking the box <input type="checkbox"/> .
Setting the parameters for simulation of the process and/or the process valve:		
▲ / ▼	Select <i>SIM.Gain</i>	(Amplification factor).
INPUT	Press 	The input screen for specifying the amplification factor is opened.
▲ / ▼	+ Increase value <- Select decimal place	Input value.
OK	Press 	Transfer and simultaneous return to the <i>CONTROL.sim</i> menu.
▲ / ▼	Select <i>SIM.Delay</i>	(Time constant in seconds).
INPUT	Press 	The input screen for specifying the time constant is opened.
▲ / ▼	+ Increase value <- Select decimal place	Input value.
OK	Press 	Transfer and simultaneous return to the <i>CONTROL.sim</i> menu.
EXIT	Press 	Return to the <i>SIMULATION</i> menu.
EXIT	Press 	Return to the main menu (MAIN).
EXIT	Press 	Switching from setting level \Rightarrow process level.

Table 71: *CONTROL.sim; activating and parameterizing simulation of the process and/or process valve*

25.2.21 DIAGNOSE – Menu for monitoring valves (option)

The optional function *DIAGNOSE* can be used to monitor the state of the valve. If there are deviations from the set-point state, messages are output according to NE 107.

Example of the output of a diagnosis message:

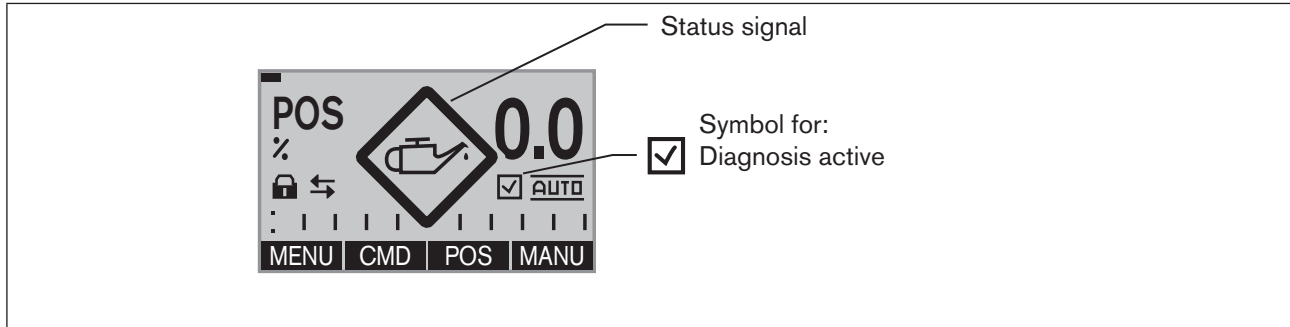



Figure 92: Example of a diagnosis message

25.2.21.1. Activation of the *DIAGNOSE* menu

To ensure that the *DIAGNOSE* menu can be set, it must first be activated in the main menu of the setting level (MAIN) via *ADD.FUNCTION*. See chapter “25.1 Activating and deactivating auxiliary functions”.

 The active diagnosis is indicated on the display of the process level with a check mark symbol . See “Figure 92”.

25.2.21.2. The *DIAGNOSE* main menu

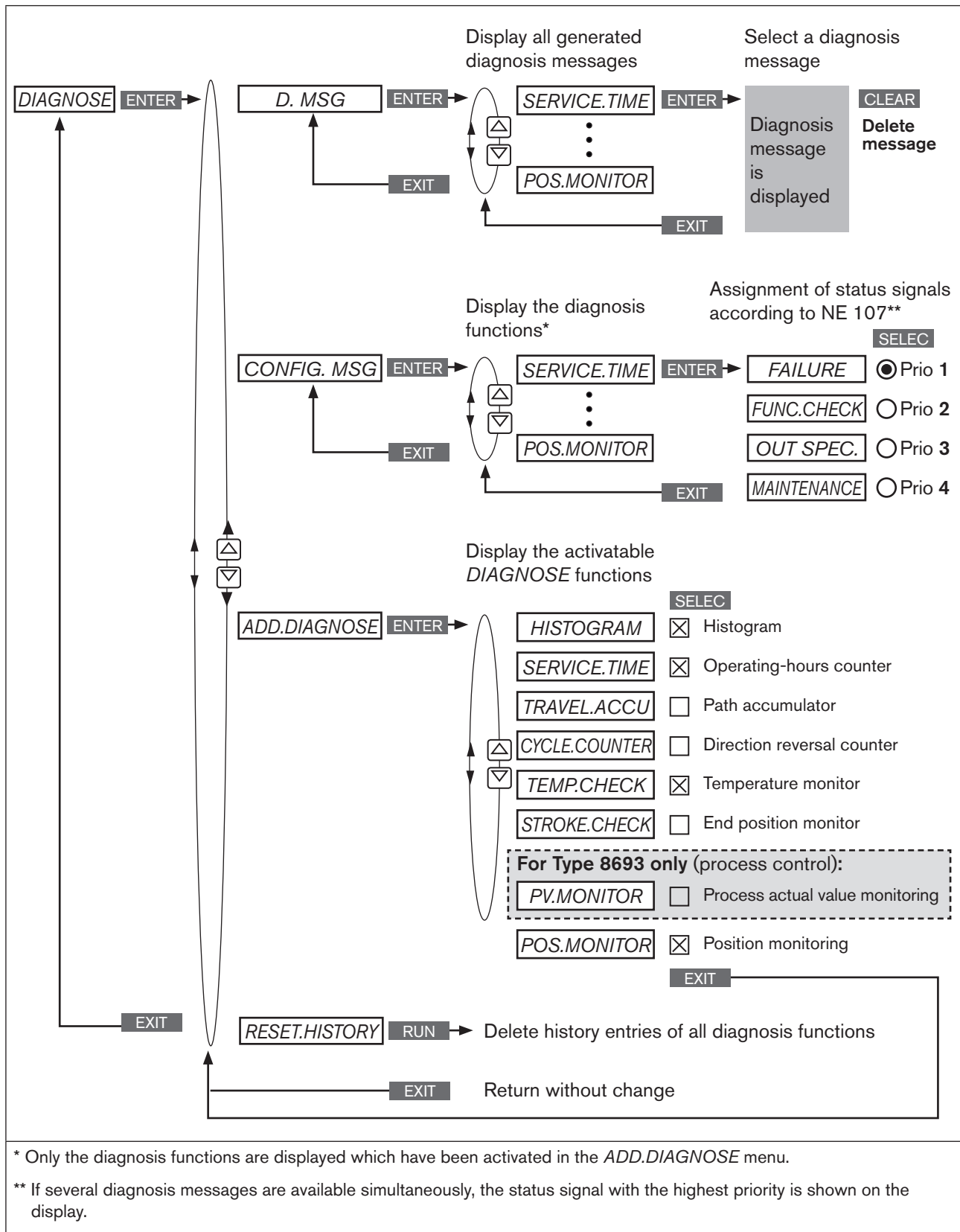
The *DIAGNOSE* main menu consists of the following submenus.

	D.MSG	(Diagnosis messages) list of all diagnosis messages.
	CONFIG.MSG	Assignment of status signals for different diagnosis messages according to NE 107 (NE = NAMUR recommendation).
	ADD.DIAGNOSE	Activation of diagnosis functions by incorporation into the <i>DIAGNOSE</i> main menu.
	RESET.HISTORY	Deletion of the history entries of all diagnosis functions. The menu is only displayed if the <i>CLOCK</i> function has been selected on the process level.

Table 72: *DIAGNOSE*; main menu

The description can be found in chapter “25.2.21.5. Description of the *DIAGNOSE* main menu”.

25.2.21.3. DIAGNOSE – Operating structure



* Only the diagnosis functions are displayed which have been activated in the ADD.DIAGNOSE menu.

** If several diagnosis messages are available simultaneously, the status signal with the highest priority is shown on the display.

MAN 1000108626 EN Version: F Status: RL (released | freigegeben) printed: 20.01.2015

152 Figure 93: Operating structure DIAGNOSE

25.2.21.4. Activation of diagnosis functions

In the *ADD.DIAGNOSE* menu several diagnosis functions are activated and incorporated into the *DIAGNOSE* main menu.

Activatable diagnosis functions:

HISTOGRAM	Graphical display of the dwell time density and movement range.
SERVICE.TIME	Operating-hours counter
TRAVEL.ACCU	Path accumulator
CYCLE.COUNTER	Direction reversal counter
TEMP.CHECK	Temperature monitor
STROKE.CHECK	Monitoring of the mechanical end positions in the armature
PV.MONITOR	Process actual value monitoring (only for Type 8693, process control)
POS.MONITOR	Position monitoring

Table 73: *ADD.DIAGNOSE*; overview of diagnosis functions

The exact description can be found in chapter "[25.2.21.6. Description of the diagnosis functions](#)"

ADD.DIAGNOSE - Activating diagnosis functions:







Key	Action	Description
MENU	Press  for approx. 3 s	Switching from process level ⇔ setting level.
▲ / ▼	Select <i>DIAGNOSE</i>	(To do this, the <i>DIAGNOSE</i> auxiliary function must already have been activated by incorporation into the main menu (MAIN)).
ENTER	Press 	The submenus are displayed.
▲ / ▼	Select <i>ADD.DIAGNOSE</i>	
ENTER	Press 	The other diagnosis functions are displayed.
▲ / ▼	Select required diagnosis function	
ENTER	Press 	The required diagnosis function is now marked by a cross ☒.
either		
▲ / ▼	Select further diagnosis functions	Keep repeating until all required diagnosis functions have been marked with a cross ☒.
ENTER	Press 	
or		
EXIT	Press 	Acknowledgment and simultaneous return to the <i>DIAGNOSE</i> main menu. The marked diagnosis functions have been activated and the setting menus are now in the <i>DIAGNOSE</i> main menu.

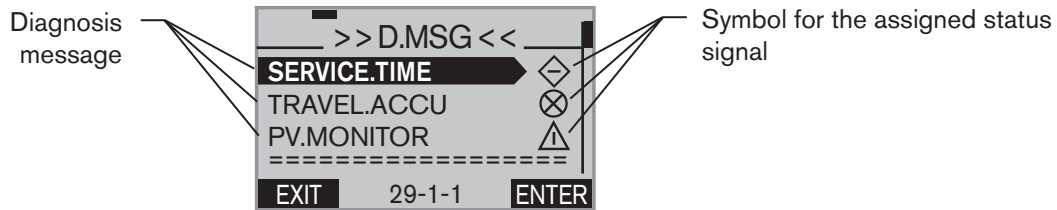
Table 74: *Activation of diagnosis functions*

25.2.21.5. Description of the *DIAGNOSE* main menu

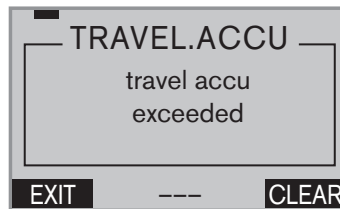
1. D.MSG – Diagnosis messages

All generated diagnosis messages are listed in the D.MSG menu where they can be viewed and deleted. The status signal, which is assigned to the diagnosis message, is indicated by a symbol.

Display example of a list with diagnosis messages



Display example of the description text of a diagnosis message



Viewing and deleting a diagnosis message:

Key	Action	Description
▲ / ▼	Select <i>D.MSG</i>	
ENTER	Press	All generated diagnosis messages are displayed.
▲ / ▼	Select required message	
ENTER	Press	Opening the diagnosis message. The description text is displayed (in English).
EXIT	Press	Closing the diagnosis message and return to <i>D.MSG</i> .
or CLEAR	Hold down as long as countdown (5 ...) is running	Deleting the diagnosis message and return to <i>D.MSG</i> .
EXIT	Press	Return to the <i>DIAGNOSE</i> main menu.

Table 75: *D.MSG*; viewing and deleting a diagnosis message

2. CONFIG.MSG – Assignment of status signals according to NE 107 (NAMUR recommendation)

The status signals of the diagnosis messages can be changed in the CONFIG.MSG menu.

The menu indicates only diagnosis functions which can output a message and which have already been activated in the *ADD.DIAGNOSE* menu.

If several diagnosis messages are available with different status signals, the status signal with the highest priority is shown on the display.

Overview of the status signals according to NE 107 (NE = NAMUR recommendation):

Priority	1	2	3	4
Status signal				
Description	Failure	Function check	Out of specification	Maintenance required

Table 76: CONFIG.MSG; overview of status signals

The following status signals have been preset at the factory for the messages of the diagnosis functions:

Diagnosis function	Status signal according to NE 107	Signal Miniature	Priority
SERVICE.TIME	Maintenance required		4
TRAVEL.ACCU	Maintenance required		4
CYCLE.COUNTER	Maintenance required		4
TEMP.CHECK	Out of specification		3
STROKE.CHECK	Out of specification		3
PV.MONITOR	Out of specification		3
POS.MONITOR	Out of specification		3

Table 77: CONFIG.MSG; factory setting (Default)

Assignment of status signals:

Key	Action	Description
▲ / ▼	Select CONFIG.MSG	
ENTER	Press	All activated diagnosis functions, which can output a message, are displayed.
▲ / ▼	Select required diagnosis function	
ENTER	Press	The list of possible status signals is displayed.
▲ / ▼	Select required status signal	
SELEC	Press	The selected status signal is now marked by a filled circle ●.
EXIT	Press	Acknowledgment and simultaneous return to the CONFIG.MSG menu. The status signal is now assigned to the diagnosis function.
EXIT	Press	Return to the DIAGNOSE main menu.

Table 78: CONFIG.MSG; assignment of status signals

MAN 1000108626 EN Version: F Status: RL (released | freigegeben) printed: 20.01.2015

3. **ADD.DIAGNOSE** – Activation and deactivation of diagnosis functions

Diagnosis functions can be activated in this menu and incorporated into the *DIAGNOSE* main menu or already activated diagnosis functions can be deactivated again.

Activation of diagnosis functions:

For description see chapter "[25.2.21.4. Activation of diagnosis functions](#)"

Deactivation of diagnosis functions:

The procedure is the same as for activation. Except that with deactivation the cross after the diagnosis function is removed again by pressing the **ENTER** key .

4. **RESET.HISTORY** – Deletion of the history entries of all diagnosis functions

Explanation of the history entries:

There is a history entry for each diagnosis message. This entry is assigned to the diagnosis function, which has actuated this message, and is saved there in the *HISTORY* submenu.



In the menu of some diagnosis functions there is a *HISTORY* submenu in which the history entries are saved.

RESET.HISTORY is used to delete the entries of all *HISTORY* submenus.

Individual entries can be deleted in the *HISTORY* submenu of the particular diagnosis function.

See also chapter "[25.2.21.7. History entries in the HISTORY submenu](#)".

Deleting all history entries:



Key	Action	Description
▲ / ▼	Select <i>RESET.HISTORY</i>	
RUN	 Hold down as long as countdown (5 ...) is running	All history entries are deleted.
EXIT	Press 	Return to the <i>DIAGNOSE</i> main menu.

Table 79: *RESET.HISTORY*; deleting all history entries

CAUTION!



History entries are only created when the *CLOCK* function for the display has been activated on the process level.

For activation and setting of *CLOCK* see chapter "[16.4.1 Setting date and time:](#)"

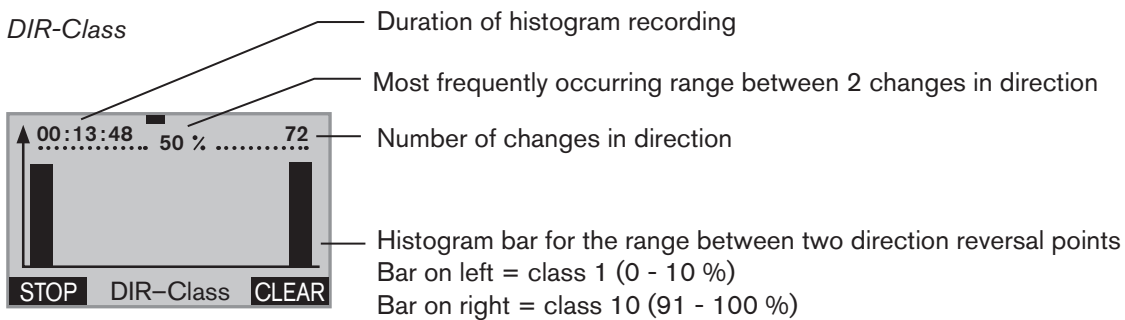
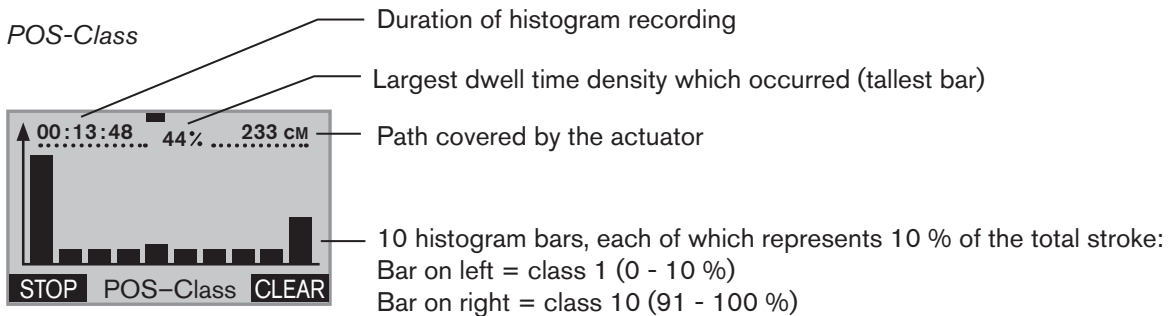
25.2.21.6. Description of the diagnosis functions

HISTOGRAM – Output of histograms

The *HISTOGRAM* menu is divided into 2 parts:

1. **Outputting the histograms** for
POS class (dwell time density) and
DIR class (movement range)
2. **List of the characteristic values** for
 CMD Set-point position valve actuator
 POS Actual position valve actuator
 DEV Deviation from POS to CMD
 TEMP Temperature
 SP Process set-point value
 PV Process actual value

Display description of the histograms:



Operating structure:

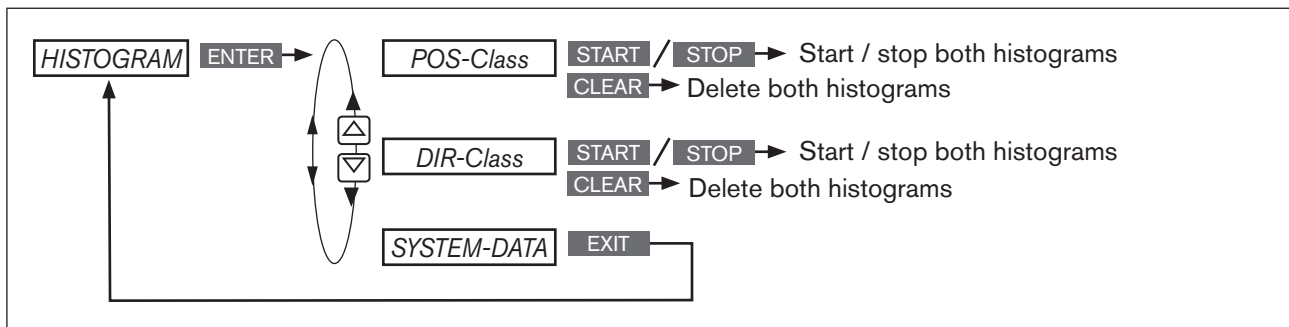


Figure 94: *HISTOGRAM*; operating structure

POS-Class - Description of the histogram of the dwell time density

The histogram indicates how long the actuator has stopped in a specific position.

For this purpose the stroke range is divided into 10 classes.

The current position of one of the 10 classes is assigned to each scan time.

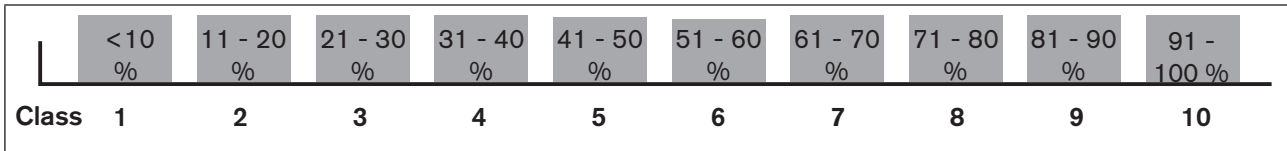


Figure 95: CMD class; position classes

Explanation of the histogram in the example

Sinusoidal progression of the actuator position:

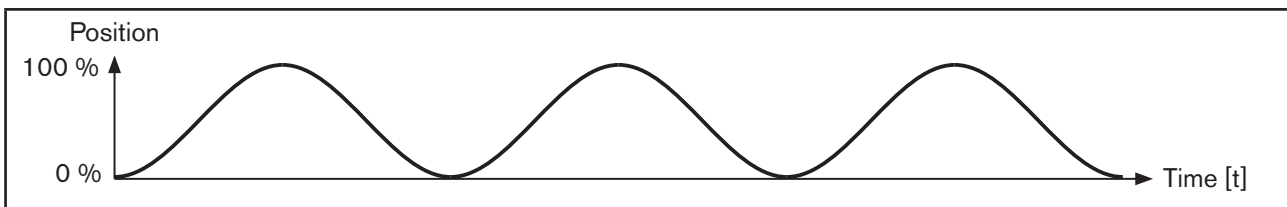


Figure 96: Sinusoidal progression of the actuator position

Histogram of the sinusoidal progression of the actuator position:

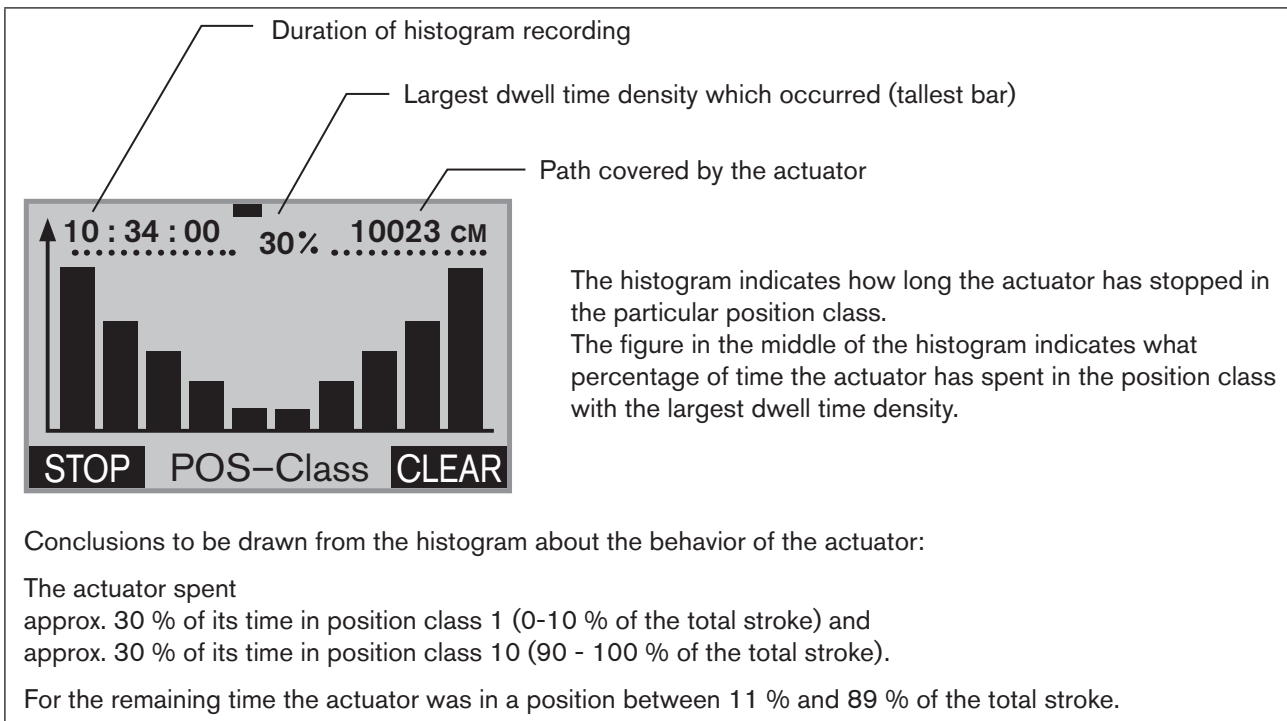


Figure 97: POS class; histogram of the dwell time density for sinusoidal progression of the actuator position

! The distribution of the histogram allows conclusions to be drawn about the design of the control valve. For example, if the actuator is in the lower stroke range only, the valve has probably been designed too large.

MAN 1000108626 EN Version: F Status: RL (released | freigegeben) printed: 20.01.2015

DIR-Class - Description of the histogram of the movement range

The histogram indicates the movement ranges of the actuator between two direction reversal points. For this purpose the movement range between two changes in direction is divided into 10 classes. The current position of one of the 10 classes is assigned to each scan time.

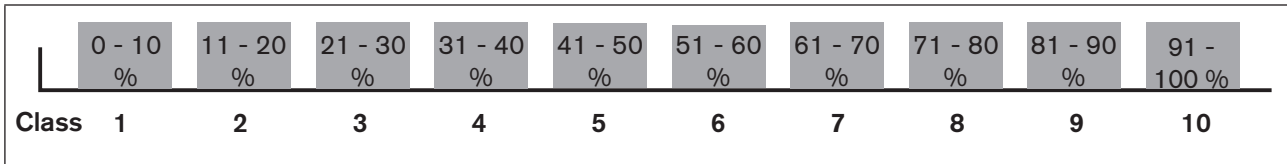


Figure 98: DIR class; change in direction classes

Explanation of the histogram in the example

Sinusoidal progression of the actuator position:

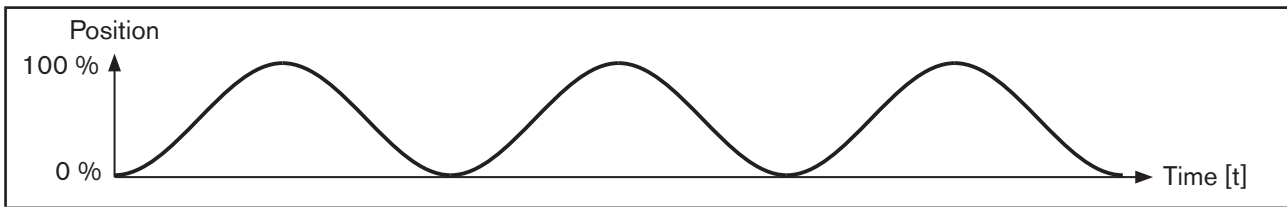


Figure 99: Sinusoidal progression of the actuator position

Histogram of the sinusoidal progression of the actuator position:

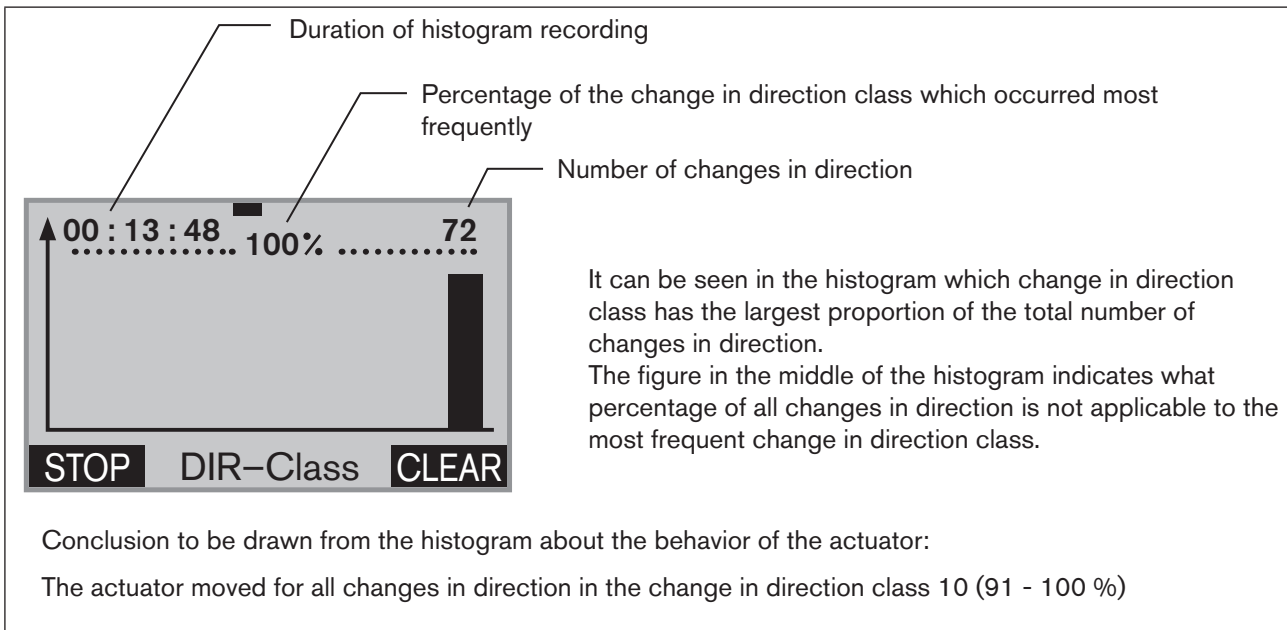


Figure 100: DIR class; histogram of the dwell time density for sinusoidal progression of the actuator position



The histograms will only give correct information about the behavior of the actuator when the X.TUNE function required for the basic setting has been run.

MAN 1000108626 EN Version: F Status: RL (released | freigegeben) printed: 20.01.2015

Starting, stopping and deleting the histograms







Key	Action	Description
▲ / ▼	Select <i>HISTOGRAM</i>	(To do this, the <i>HISTOGRAM</i> function must be incorporated into the <i>DIAGNOSE</i> main menu. See chapter " 25.2.21.4. Activation of diagnosis functions ").
ENTER	Press 	The empty matrix of the <i>POS-Class</i> submenu (dwell time density) is displayed.
Starting histograms:		
START *	 Hold down as long as countdown (5 ...) is running	Both histograms (<i>POS class</i> and <i>DIR class</i>) are started.
▲ / ▼	Changing the display view	Selection options: <i>POS class</i> (Histogram for the dwell time density), <i>DIR class</i> (Histogram for the movement range), <i>SYSTEM DATA</i> (list of the characteristic values).
Stopping histograms:		
STOP *	 Hold down as long as countdown (5 ...) is running	The recording of both histograms (<i>POS class</i> and <i>DIR class</i>) is stopped.
▲ / ▼	Changing the display view	Selection options: <i>POS class</i> (Histogram for the dwell time density), <i>DIR class</i> (Histogram for the movement range), <i>SYSTEM DATA</i> (list of the characteristic values).
Deleting histograms:		
CLEAR *	 Hold down as long as countdown (5 ...) is running	Both histograms (<i>POS class</i> and <i>DIR class</i>) are deleted.
Return to the <i>DIAGNOSE</i> main menu:		
▲ / ▼	Select <i>SYSTEM DATA</i>	
EXIT	Press  or 	Return to the <i>DIAGNOSE</i> main menu.
* The key functions START , STOP and CLEAR are available only in the display views of the histograms <i>POS class</i> and <i>DIR class</i> .		

Table 80: *HISTOGRAM*; starting, stopping and deleting histograms

SERVICE.TIME – Operating-hours counter

The operating-hours counter records the time during which the device was switched on.

If the duty cycle reaches the specified time limit, a message is generated.

- To do this, a history entry is made in the *HISTORY* submenu. For description see “25.2.21.7. History entries in the *HISTORY* submenu”.
- The status signal, which is assigned to the message, is indicated at short intervals on the display. See also *D.MSG* and *CONFIG.MSG* in chapter “25.2.21.5”, page 154.

Display <i>SERVICE.TIME</i>	Description of the functions
	<p>The interval for messages preset at the factory for 90 days can be changed in the <i>LIMIT</i> submenu.</p> <p>After <i>NEXT.M</i> the remaining time is displayed until the next message appears.</p> <p>The history entries of the last 3 messages can be viewed and deleted in the <i>HISTORY</i> submenu.</p>

Table 81: *SERVICE.TIME*; operating-hours counter

Operating structure:

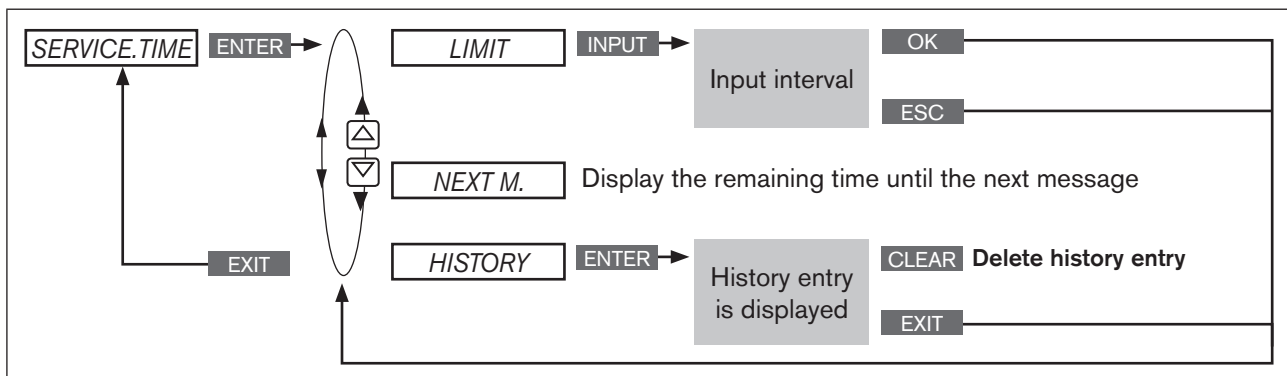


Figure 101: Operating structure *SERVICE.TIME*

Specifying interval for the output of messages

Key	Action	Description
▲ / ▼	Select <i>SERVICE.TIME</i>	(To do this, the <i>SERVICE.TIME</i> function must be incorporated into the <i>DIAGNOSE</i> main menu. See chapter “25.2.21.4. Activation of diagnosis functions”).
ENTER	Press	The menu is displayed.
▲ / ▼	Select <i>LIMIT</i>	
INPUT	Press	The preset value is displayed.
▲ / ▼	+ Increase value ← Change the (time unit: d/h/m)	Set interval for outputting the message.
OK	Press	Return to the <i>SERVICE.TIME</i> menu.
EXIT	Press	Return to the <i>DIAGNOSE</i> main menu.

Table 82: *SERVICE.TIME*; specifying interval.

MAN 1000108626 EN Version: F Status: RL (released | freigegeben) printed: 20.01.2015

TRAVEL.ACCU – Path accumulator

The path accumulator records and adds up the path which the actuator piston covers. A movement of the actuator piston is detected when the position changes by at least 1 %.

The interval for outputting messages is specified by inputting a limit for the total number of piston movements.

- To do this, a history entry is made in the *HISTORY* submenu. For description see “25.2.21.7. History entries in the HISTORY submenu”.
- The status signal, which is assigned to the message, is indicated at short intervals on the display. See also *D.MSG* and *CONFIG.MSG* in chapter “25.2.21.5”, page 154.

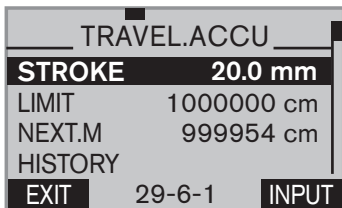
Display TRAVEL.ACCU	Description of the functions
	<p>The <i>STROKE</i> submenu specifies the total stroke of the actuator piston. The total stroke is automatically determined during the basic setting of the device (running <i>X.TUNE</i>).</p> <p>In the case of an analog position sensor, the total stroke must be input by pressing the INPUT key.</p> <p>The interval for outputting the message can be changed in the <i>LIMIT</i> submenu. A piston movement which covers 10 km has been preset at the factory.</p> <p>After <i>NEXT.M</i> the remaining piston movement distance is displayed until the next message appears.</p> <p>The history entries of the last 3 messages can be viewed and deleted in the <i>HISTORY</i> submenu.</p>

Table 83: TRAVEL.ACCU; path accumulator

Operating structure:

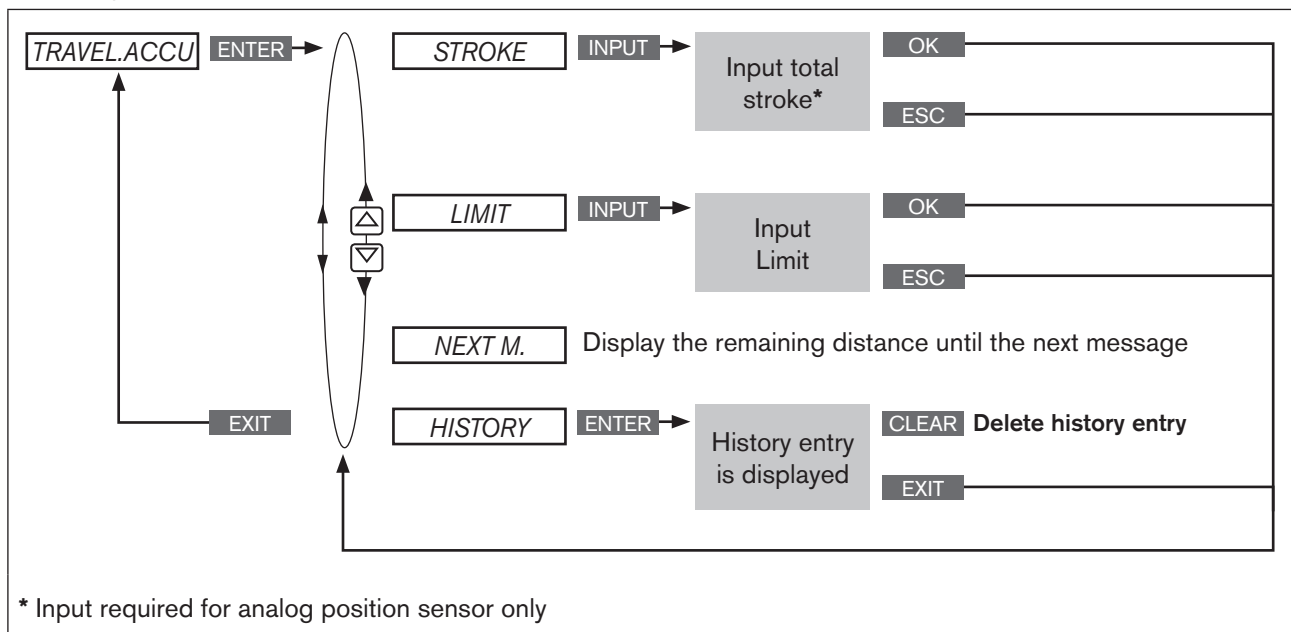


Figure 102: Operating structure TRAVEL.ACCU

Specifying interval for the output of messages

Key	Action	Description
▲ / ▼	Select <i>TRAVEL.ACCU</i>	(To do this, the <i>TRAVEL.ACCU</i> function must be incorporated into the <i>DIAGNOSE</i> main menu. See chapter “ 25.2.21.4. Activation of diagnosis functions ”).
ENTER	Press	The menu is displayed.
* Required for analog position sensor only (setting the <i>STROKE</i> submenu)		
▲ / ▼ *	Select <i>STROKE</i>	
INPUT *	Press	The preset value is displayed.
▲ / ▼ *	Increase value Changing the decimal place	Set total stroke of the actuator piston.
▲ / ▼	Select <i>LIMIT</i>	
INPUT	Press	The preset value is displayed.
▲ / ▼	Increase value Changing the decimal place	Setting interval for outputting the message (limit for total number of piston movements).
OK	Press	Return to the <i>TRAVEL.ACCU</i> menu.
EXIT	Press	Return to the <i>DIAGNOSE</i> main menu.

Table 84: *TRAVEL.ACCU*; specifying interval.

CYCLE.COUNTER – Direction reversal counter

The direction reversal counter counts the number of changes in direction of the actuator piston. A change in direction is detected when the position of the actuator piston changes by at least 1 %.

The interval for outputting messages is specified by inputting a limit for the total number of changes in direction.

- To do this, a history entry is made in the *HISTORY* submenu. For description see “[25.2.21.7. History entries in the HISTORY submenu](#)”.
- The status signal, which is assigned to the message, is indicated at short intervals on the display. See also *D.MSG* and *CONFIG.MSG* in chapter “[25.2.21.5](#)”, page 154.

Display <i>CYCLE.COUNTER</i>	Description of the functions
	<p>The interval for outputting the message can be changed in the <i>LIMIT</i> submenu. 1 million changes in direction have been preset at the factory.</p> <p>After <i>NEXT.M</i> the remaining changes in direction are displayed until the next message appears.</p> <p>The history entries of the last 3 messages can be viewed and deleted in the <i>HISTORY</i> submenu.</p>

Table 85: *SERVICE.TIME*; operating-hours counter

MAN 1000108626 EN Version: F Status: RL (released | freigegeben) printed: 20.01.2015

Operating structure:

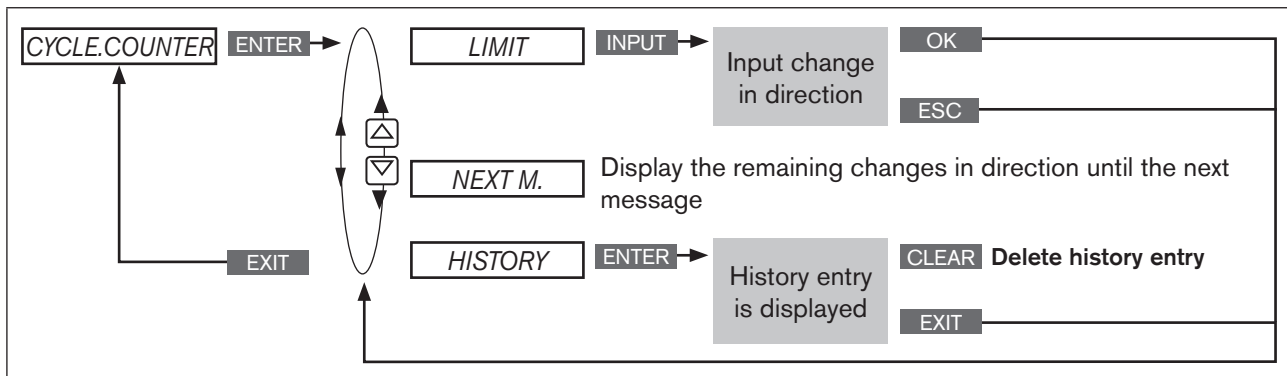


Figure 103: Operating structure *CYCLE.COUNTER*

Specifying interval for the output of messages

Key	Action	Description
▲ / ▼	Select <i>CYCLE.COUNTER</i>	(To do this, the <i>CYCLE.COUNTER</i> function must be incorporated into the <i>DIAGNOSE</i> main menu. See chapter “25.2.21.4. Activation of diagnosis functions”.)
ENTER	Press	The menu is displayed.
▲ / ▼	Select <i>LIMIT</i>	
INPUT	Press	The preset value is displayed.
▲ / ▼	+ Increase value ← Changing the decimal place	Setting interval for outputting the message (limited number of changes in direction).
OK	Press	Return to the <i>CYCLE.COUNTER</i> menu.
EXIT	Press	Return to the <i>DIAGNOSE</i> main menu.

Table 86: *CYCLE.COUNTER*; specifying interval.

TEMP.CHECK – Temperature monitor

The temperature monitor checks whether the current temperature is within the specified temperature range. The temperature range is specified by inputting a minimum and maximum temperature. If the temperature deviates from the specified range, a message is output.

- To do this, a history entry is made in the *HISTORY* submenu. For description see “25.2.21.7. History entries in the *HISTORY* submenu”.
- The status signal, which is assigned to the message, is indicated at short intervals on the display. See also *D.MSG* and *CONFIG.MSG* in chapter “25.2.21.5”, page 154.

In addition to the monitor there is a temperature slave pointer. This indicates the lowest and highest of the measured temperature values. The slave pointer can be reset by pressing the **CLEAR** key.

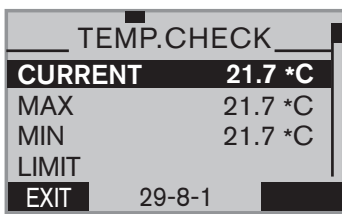

Display <i>TEMP.CHECK</i>	Description of the functions
	<p><i>CURRENT</i> indicates the current temperature.</p> <p><i>MAX</i> indicates the highest temperature of the slave pointer</p> <p><i>MIN</i> indicates the lowest temperature of the slave pointer</p> <p>The permitted temperature range can be changed in the <i>LIMIT</i> submenu. A message is output if the temperature goes outside the permitted range. The temperature range has been preset at the factory from 0 ... 60 °C.</p> <p>The history entries of the last 3 messages can be viewed and deleted in the <i>HISTORY</i> submenu.</p>
	

Table 87: *TEMP.CHECK*; temperature range

Operating structure:

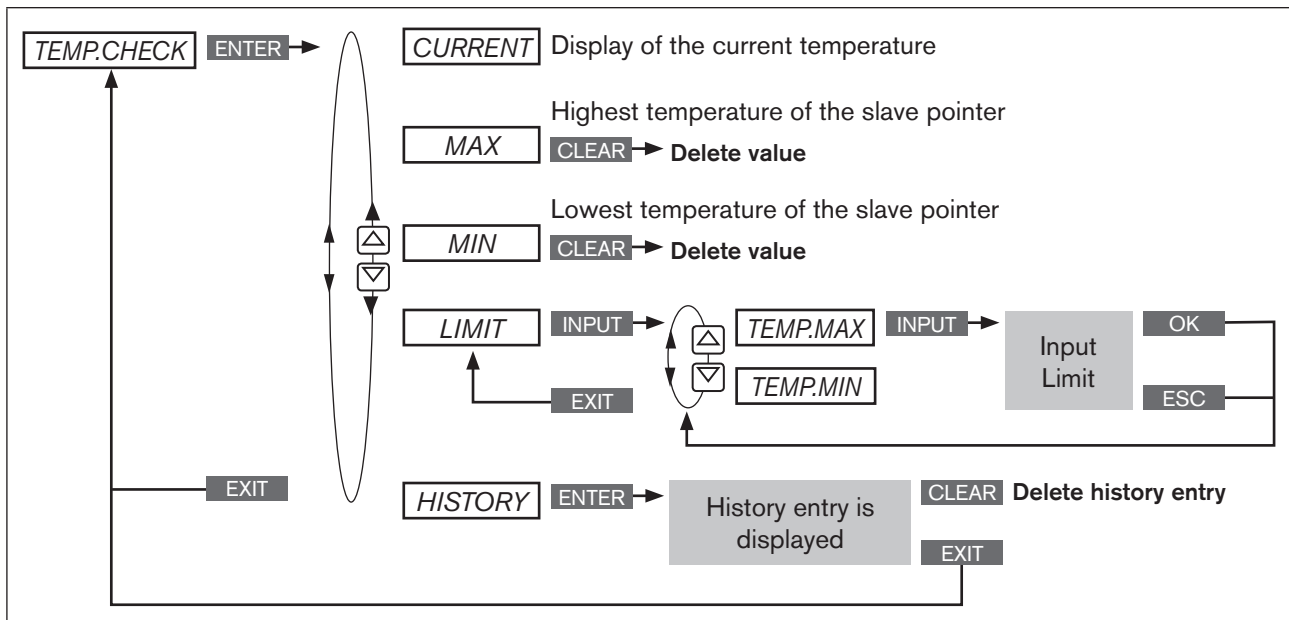





Figure 104: Operating structure *TEMP.CHECK*

Specifying temperature limit for the output of messages

Key	Action	Description
▲ / ▼	Select <i>TEMP.CHECK</i>	(To do this, the <i>TEMP.CHECK</i> function must be incorporated into the <i>DIAGNOSE</i> main menu. See chapter " 25.2.21.4. Activation of diagnosis functions ").
ENTER	Press 	The menu is displayed.
▲ / ▼	Select <i>LIMIT</i>	
ENTER	Press 	The upper and lower temperature limit is displayed. The upper limit <i>TEMP.MAX</i> has already been selected.
INPUT	Press 	Open input screen for upper temperature limit.






Key	Action	Description
▲ / ▼	<p>+ Increase value</p> <p><- Changing the decimal place</p>	Input upper temperature limit <i>TEMP.MAX</i> .
OK	Press 	Acknowledge value.
▲ / ▼	Select <i>TEMP.MIN</i>	
INPUT	Press 	Open factory setting for lower temperature limit.
▲ / ▼	<p>+ Increase value</p> <p><- Changing the decimal place</p>	Input lower temperature limit <i>TEMP.MIN</i> .
OK	Press 	Acknowledge value.
EXIT	Press 	Return to the <i>TEMP.CHECK</i> menu.
EXIT	Press 	Return to the <i>DIAGNOSE</i> main menu.

Table 88: *TEMP.CHECK*; specifying temperature limit.

STROKE.CHECK – End position monitor

The *STROKE.CHECK* function is used to monitor the physical end positions of the armature. In this way wear marks can be detected on the valve seat.

To do this, a tolerance band is specified for the lower end position (position 0 %) and for the upper end position (position 100 %). If an end position exceeds or falls below the tolerance band, a message is output.

- To do this, a history entry is made in the *HISTORY* submenu. For description see [“25.2.21.7. History entries in the HISTORY submenu”](#).
- The status signal, which is assigned to the message, is indicated at short intervals on the display. See also *D.MSG* and *CONFIG.MSG* in chapter [“25.2.21.5”](#), page 154.

In addition to the monitor there is an end position slave pointer. This indicates the minimum and maximum position of the determined end positions. The slave pointer can be reset by pressing the **CLEAR** key.

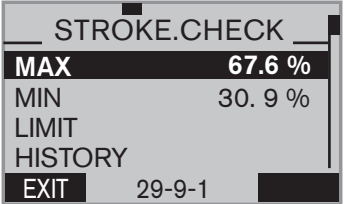
Display <i>STROKE.CHECK</i>	Description of the functions
	<p><i>MAX</i> indicates the maximum position of the slave pointer</p> <p><i>MIN</i> indicates the minimum position of the slave pointer</p> <p>The tolerance band for the physical end positions can be set in the <i>LIMIT</i> submenu. A message is output if the temperature goes outside the permitted range.</p> <p>Example: Input upper end position <i>TOL MAX</i> = 1 % If the position is less than -1 %, a message is output</p> <p>Input lower end position <i>TOL ZERO</i> = 1 % If the position is greater than 101 %, a message is output</p> <p>The history entries of the last 3 messages can be viewed and deleted in the <i>HISTORY</i> submenu.</p>

Table 89: *STROKE.CHECK*; end position monitor

CAUTION!



If a stroke limit was set in the *X.LIMIT* menu, the mechanical end position monitor has only limited relevance.

The end positions indicated on the process level under *POS* are not the physically caused end positions in this case. Therefore they cannot be compared with the end positions indicated in the *STROKE.CHECK* menu under *MIN* and *MAX*.

Operating structure:

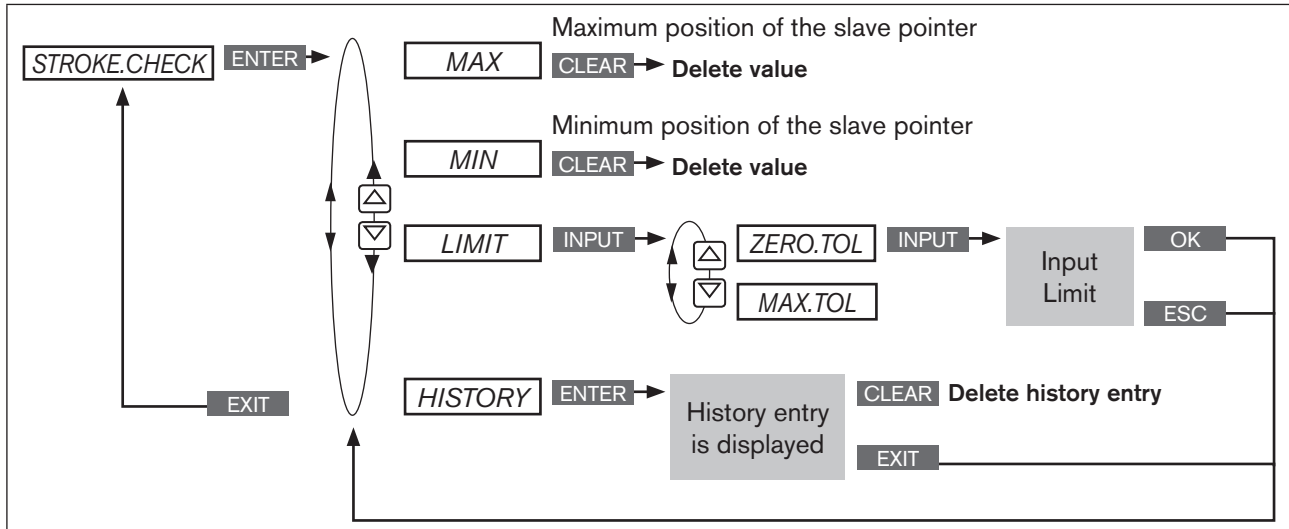


Figure 105: Operating structure *STROKE.CHECK*

Specifying position limit for the output of messages

Key	Action	Description
▲ / ▼	Select <i>STROKE.CHECK</i>	(To do this, the <i>STROKE.CHECK</i> function must be incorporated into the <i>DIAGNOSE</i> main menu. See chapter “25.2.21.4. Activation of diagnosis functions”).
ENTER	Press	The menu is displayed.
▲ / ▼	Select <i>LIMIT</i>	
ENTER	Press	The submenus for inputting the lower and upper end position tolerance are displayed. The submenu for inputting the lower end position tolerance <i>ZERO.TOL</i> has already been selected.
INPUT	Press	Open input screen for lower end position tolerance.
▲ / ▼	+ Increase value - Changing the decimal place	Input lower end position tolerance <i>ZERO.TOL</i> .
OK	Press	Acknowledge value.
▲ / ▼	Select <i>MAX.TOL</i>	
INPUT	Press	Open input screen for upper end position tolerance.
▲ / ▼	+ Increase value - Changing the decimal place	Input upper end position tolerance <i>MAX.TOL</i> .




Key	Action	Description
OK	Press 	Acknowledge value.
EXIT	Press 	Return to the <i>STROKE.CHECK</i> menu.
EXIT	Press 	Return to the <i>DIAGNOSE</i> main menu.

Table 90: *STROKE.CHECK*; end position monitor.

POS.MONITOR –Position monitoring

The *POS.MONITOR* function monitors the current position of the actuator.

The tolerance band for the set-point value is specified in the *DEADBAND* submenu.

A period for alignment of the actual value with the set-point value is specified in the *COMP.TIME* submenu (compensation time).

The compensation time *COMP.TIME* starts recording as soon as the set-point value is constant. When the compensation time has elapsed, monitoring starts.

If the control deviation (DEV) of the actual value is greater than the tolerance band of the set-point value during monitoring, a message is output.

- To do this, a history entry is made in the *HISTORY* submenu. For description see “25.2.21.7. History entries in the *HISTORY* submenu”.
- The status signal, which is assigned to the message, is indicated at short intervals on the display. See also *D.MSG* and *CONFIG.MSG* in chapter “25.2.21.5”, page 154.

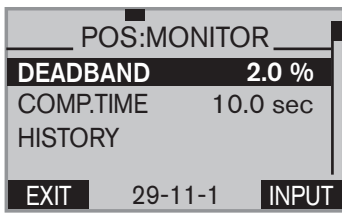
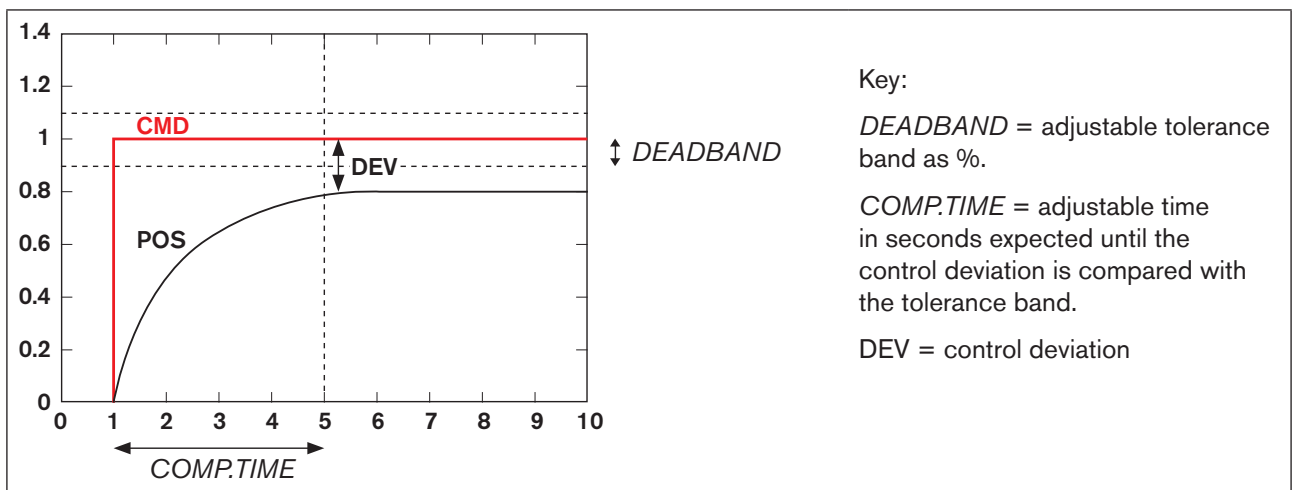
Display <i>POS.MONITOR</i>	Description of the functions
	<p>The tolerance band of the set-point value preset at the factory to 2 % can be changed in the <i>DEADBAND</i> submenu.</p> <p>The compensation time is set in <i>COMP.TIME</i> (compensation time).</p> <p>The history entries of the last 3 messages can be viewed and deleted in the <i>HISTORY</i> submenu.</p>

Table 91: *POS.MONITOR*; position monitor

Schematic representation



Operating structure:

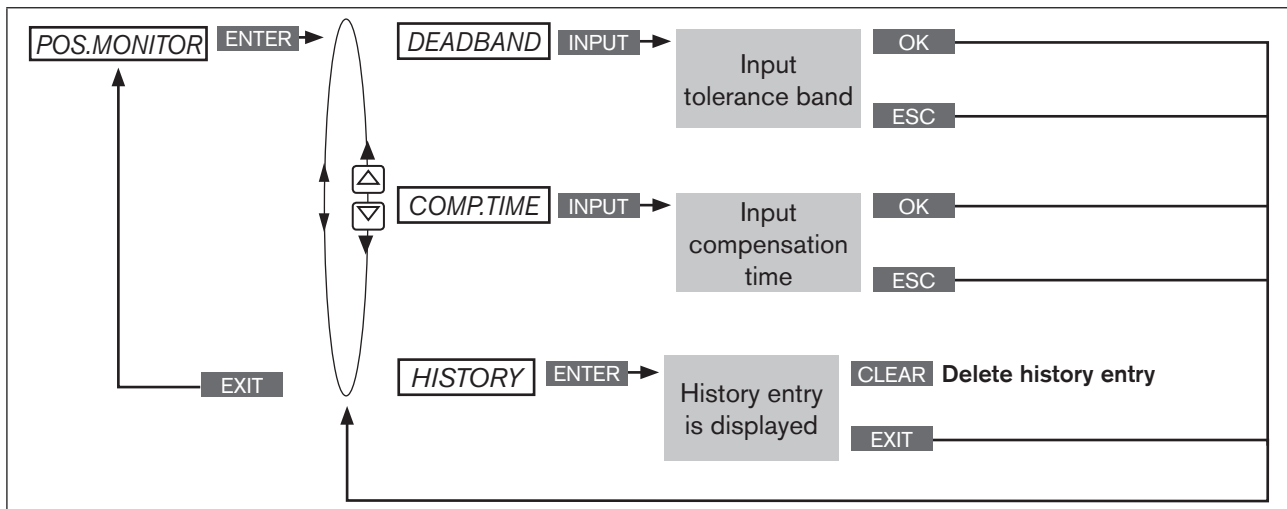


Figure 107: Operating structure POS.MONITOR

Inputting tolerance band and compensation time

Key	Action	Description
▲ / ▼	Select POS.MONITOR	(To do this, the POS.MONITOR function must be incorporated into the DIAGNOSE main menu. See chapter “25.2.21.4. Activation of diagnosis functions”).
ENTER	Press	The menu is displayed. DEADBAND has already been selected.
INPUT	Press	The preset value is displayed.
▲ / ▼	+ Increase value ← Changing the decimal place	Input tolerance band.
OK	Press	Acknowledge value.
▲ / ▼	Select COMP.TIME	
INPUT	Press	The preset value is displayed.
▲ / ▼	+ Increase value ← Changing the decimal place	Input compensation time.
OK	Press	Return to the POS.MONITOR menu.
EXIT	Press	Return to the DIAGNOSE main menu.

Table 92: POS.MONITOR; specifying tolerance band and compensation time.

PV.MONITOR – Process monitor (for Type 8693 only)

The PV.MONITOR function monitors the process actual value.

The operating menu is identical to the position monitor POS.MONITOR described above. In contrast, it is not the position of the actuator which is monitored here but the process.

25.2.21.7. History entries in the *HISTORY* submenu

Each diagnosis function, which can output a message, has the *HISTORY* submenu.

When the diagnosis message is actuated, a history entry is created with date and value. The history entries of the respective diagnosis function can be viewed and deleted in the *HISTORY* submenu.

A maximum of three history entries are stored from each diagnosis message. If three history entries are already available when a message is actuated, the oldest history entry is deleted.

Example: History of the diagnosis function *TRAVEL.ACCU*

TRAVEL.ACCU	
DATE	VALUE
01.02.12	5 cm
01.02.12	35 cm
01.02.12	10 cm
EXIT	CLEAR

Description:

On the left of the display is the date and on the right the associated value.

Deleting the history:

Hold down the **CLEAR** key until the countdown (5...) is running.



The *RESET.HISTORY* diagnosis menu can be used to jointly delete the histories of all diagnosis functions. See chapter ["25.2.21.5"](#).

Deleting the histories of a diagnosis function in the example *TRAVEL.ACCU*

Key	Action	Description
▲ / ▼	Select <i>TRAVEL.ACCU</i>	
ENTER	Press	The menu is displayed.
▲ / ▼	Select <i>HISTORY</i>	
INPUT	Press	History entries with date and value are displayed.
CLEAR	Hold down as long as countdown (5 ...) is running	The histories of the <i>TRAVEL.ACCU</i> diagnosis function are deleted.
EXIT	Press	Return to the <i>TRAVEL.ACCU</i> menu.
EXIT	Press	Return to the <i>DIAGNOSE</i> main menu.

Table 93: *SERVICE.TIME*; inputting interval for message.

CAUTION!



History entries are only created when the *CLOCK* function for the display has been activated on the process level.

To receive correct history entries, date and time must be correct.

Date and time must be reset after a restart. Therefore, the device switches immediately and automatically to the corresponding input menu after a restart.

For activation and setting of *CLOCK* see chapter ["16.4.1 Setting date and time:"](#)

25.3 Manual configuration of X.TUNE

! This function is needed for special requirements only.
For standard applications the X.TUNE function has been preset at the factory.
See chapter “22.3 X.TUNE – Automatic adjustment of the position controller”.

For special requirements the X.TUNE function, as described below, can be manually configured.

Opening the menu for the manual configuration of X.TUNE

Key	Action	Description
MENU	Press for approx. 3 s	Switching from process level \Rightarrow setting level.
\blacktriangle / \blacktriangledown	Select X.TUNE	
RUN	Briefly press	Opening the Manual.TUNE menu. The menu options for the manual configuration of X.TUNE are displayed.

X.TUNE; opening the menu for the manual configuration of X.TUNE

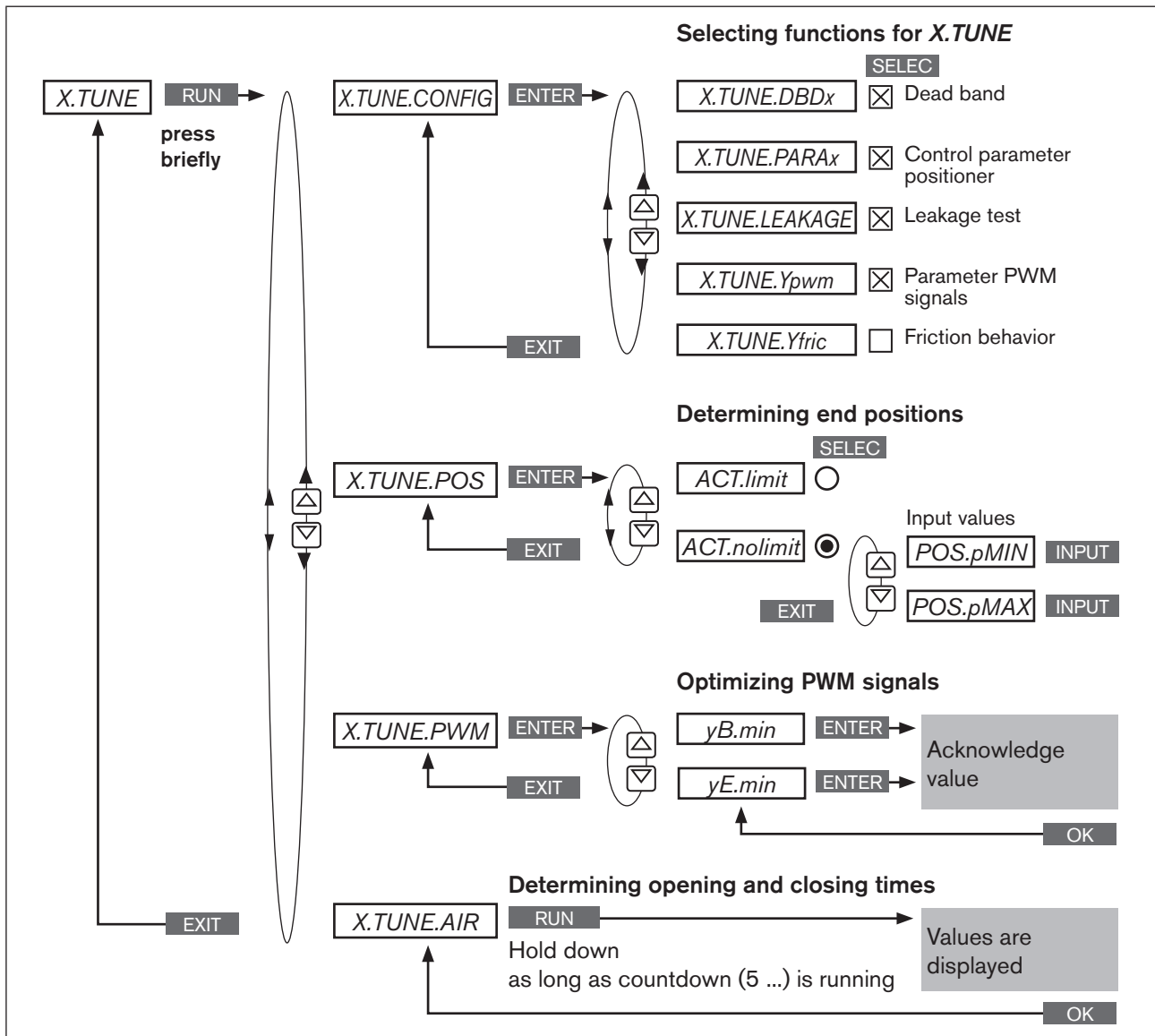


Figure 108: Operating structure for the manual configuration of X.TUNE

25.3.1 Description of the menu for the manual configuration of X.TUNE

<i>X.TUNE.CONFIG</i>	Configuration of the X.TUNE function	Specify which functions are to be executed when X.TUNE is running (automatic self-optimization).
<i>M.TUNE.POS</i>	Position of the end positions	<ul style="list-style-type: none"> - Specify whether the pneumatic actuator has mechanical end positions. - Manual specification of the end positions <p>If there are no mechanical end positions available, these are not approached by the X.TUNE and must be manually specified.</p>
<i>M.TUNE.PWM</i>	Optimization of the PWM signals	<p>Manual optimization of the PWM signals for control of the aeration valves and bleed valves.</p> <p>For optimization the valves must be aerated and bled. A progress bar on the display indicates the speed at which the valve is aerated or bled. The setting is optimum when the progress bar moves as slowly as possible.</p>
<i>M.TUNE.AIR</i>	Determination of the opening and closing times of the actuator	Continuous determination of the opening and closing times of the actuator.

25.3.1.1. X.TUNE.CONFIG – Configuration of the X.TUNE function

In this menu you can specify which functions are to be executed when the X.TUNE function is running automatically.

Specifying the functions in X.TUNE.CONFIG




Key	Action	Description
▲ / ▼	Select X.TUNE.CONFIG	
ENTER	Press 	The functions for automatic self-parameterization by X.TUNE are displayed.
▲ / ▼	Select required function	
SELEC	Press 	Activate the function by checking the box <input checked="" type="checkbox"/> .
		Select all required functions in succession using the arrow keys ▲ / ▼ and activate by checking the box <input checked="" type="checkbox"/> .
EXIT	Press 	Return to the Manual.TUNE menu.

Table 94: X.TUNE.CONFIG; specifying the functions for automatic self-parameterization by X.TUNE

25.3.1.2. X.TUNE.POS – Setting of the end positions

In this menu you can specify whether the pneumatic actuator has mechanical end positions or not. If there are no mechanical end positions available, these are not approached by the X.TUNE and must be manually specified.

Position of the end positions











Key	Action	Description
▲ / ▼	Select <i>M.TUNE.POS</i>	
ENTER	Press 	The selection for <i>ACT.limit</i> = mechanical end positions available <i>ACT.nolimit</i> = mechanical end positions not available is displayed.
If mechanical end positions are available		
▲ / ▼	Select <i>ACT.limit</i>	
SELEC	Press 	The selection is marked by a filled circle ●.
EXIT	Press 	Return to the <i>Manual.TUNE</i> menu.
If mechanical end positions are not available		
▲ / ▼	Select <i>ACT.nolimit</i>	
SELEC	Press 	The <i>CAL.POS</i> submenu for inputting the end positions is opened.
▲ / ▼	Select <i>POS.pMIN</i>	
INPUT	Press 	The input screen for the value of the lower end position is opened.
▲ / ▼	OPN Open more CLS Close more	Approach lower end position of the valve.
OK	Press 	Transfer and simultaneous return to the <i>CAL.POS</i> menu.
▲ / ▼	Select <i>POS.pMAX</i>	
INPUT	Press 	The input screen for the value of the upper end position is opened.
▲ / ▼	OPN Open more CLS Close more	Approach upper end position of the valve.
OK	Press 	Transfer and simultaneous return to the <i>CAL.POS</i> menu.
EXIT	Press 	Return to the <i>M.TUNE.POS.</i> menu.
EXIT	Press 	Return to the <i>Manual.TUNE</i> menu.

Table 95: *M.TUNE.POS*; position of the end positions

25.3.1.3. *M.TUNE.PWM* – Optimization of the PWM signals

In this menu the PWM signals for control of the aeration valves and bleed valves are manually optimized.

For optimization the actuator is aerated and bled. A progress bar on the display indicates the position of the actuator and the speed of aeration and deaeration.

The setting is optimum when the progress bar moves as slowly as possible.



WARNING!

Danger due to uncontrolled valve movement when the *M.TUNE.PWM* function is running!

When the *M.TUNE.PWM* function is running under operating pressure, there is an acute risk of injury.

- ▶ Never run *M.TUNE.PWM* while a process is running!
- ▶ Secure system against unintentional activation!

Optimization of the PWM signals











Key	Action	Description
▲ / ▼	Select <i>M.TUNE.PWM</i>	
ENTER	Press 	The submenu is displayed. <i>yB.min</i> = aeration valve <i>yE.min</i> = bleed valve
▲ / ▼	Select <i>yB.min</i>	Submenu for setting the PWM signal for the aeration valve.
ENTER	Press 	The input screen for setting the PWM signal is opened. The progress bar indicates the speed of aeration.
▲ / ▼	 Increase speed  Reduce speed	Minimize speed so that the progress bar moves as slowly as possible from left to right. Caution! Do not minimize speed to such an extent that the progress bar remains in one position.
OK	Press 	Transfer and simultaneous return to the <i>M.TUNE.PWM</i> menu.
▲ / ▼	Select <i>yE.min</i>	Submenu for setting the PWM signal for the bleed valve.
ENTER	Press 	The input screen for setting the PWM signal is opened. The progress bar indicates the speed of deaeration.
▲ / ▼	 Increase speed  Reduce speed	Minimize speed so that the progress bar moves as slowly as possible from right to left. Caution! Do not minimize speed to such an extent that the progress bar remains in one position.
OK	Press 	Transfer and simultaneous return to the <i>M.TUNE.PWM</i> menu.
EXIT	Press 	Return to the <i>Manual.TUNE</i> menu.

Table 96: *M.TUNE.PWM*; optimization of the PWM signals

25.3.1.4. *M.TUNE.AIR* – Determination of the opening and closing times

By running this function, the opening and closing times of the valve are determined continuously.

A change to the supply pressure will affect the aeration time which can be optimized in this way.

For the setting the effects, which a change to the supply pressure has on the aeration time, can be continuously monitored via the *M.TUNE.AIR* function.

Continuous determination of the opening and closing times





Key	Action	Description
▲ / ▼	Select <i>M.TUNE.AIR</i>	
RUN	 Hold down as long as countdown (5 ...) is running	The aeration and deaeration times are displayed. <i>time.open</i> = aeration <i>time.close</i> = deaeration
-	-	Change the supply pressure to adjust the aeration time. The changed aeration time is displayed continuously.
EXIT	Press 	Return to the <i>Manual.TUNE</i> menu.
EXIT	Press 	Return to the main menu (MAIN).
EXIT	Press 	Switching from setting level \Rightarrow process level.

Table 97: *M.TUNE.AIR*; continuous determination of the opening and closing times

Operating structure / Factory settings

CONTENTS

26. OPERATING STRUCTURE AND FACTORY SETTINGS	178
--	-----

26. OPERATING STRUCTURE AND FACTORY SETTINGS

The factory presets are highlighted in blue to the right of the menu in the operating structure.

Examples:

<input checked="" type="radio"/> / <input checked="" type="checkbox"/>	Menu options activated or selected at the factory
<input type="radio"/> / <input type="checkbox"/>	Menu options not activated or selected at the factory
2 %, 10 sec, ...	Values set at the factory

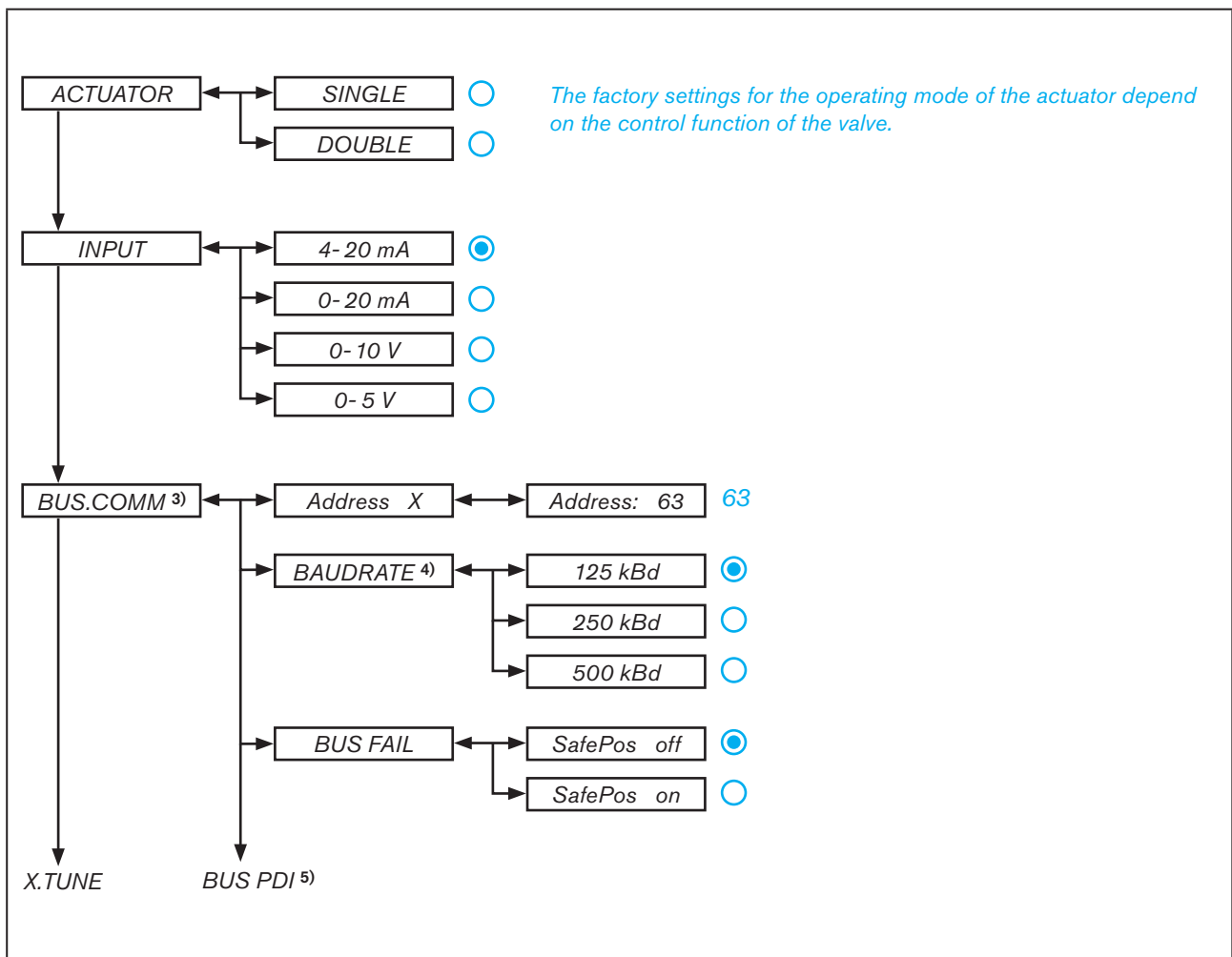


Figure 109: Operating structure - 1

3) only field bus
4) only DeviceNet
5) only PROFIBUS DP

MAN 1000108626 EN Version: F Status: RL (released | freigegeben) printed: 20.01.2015

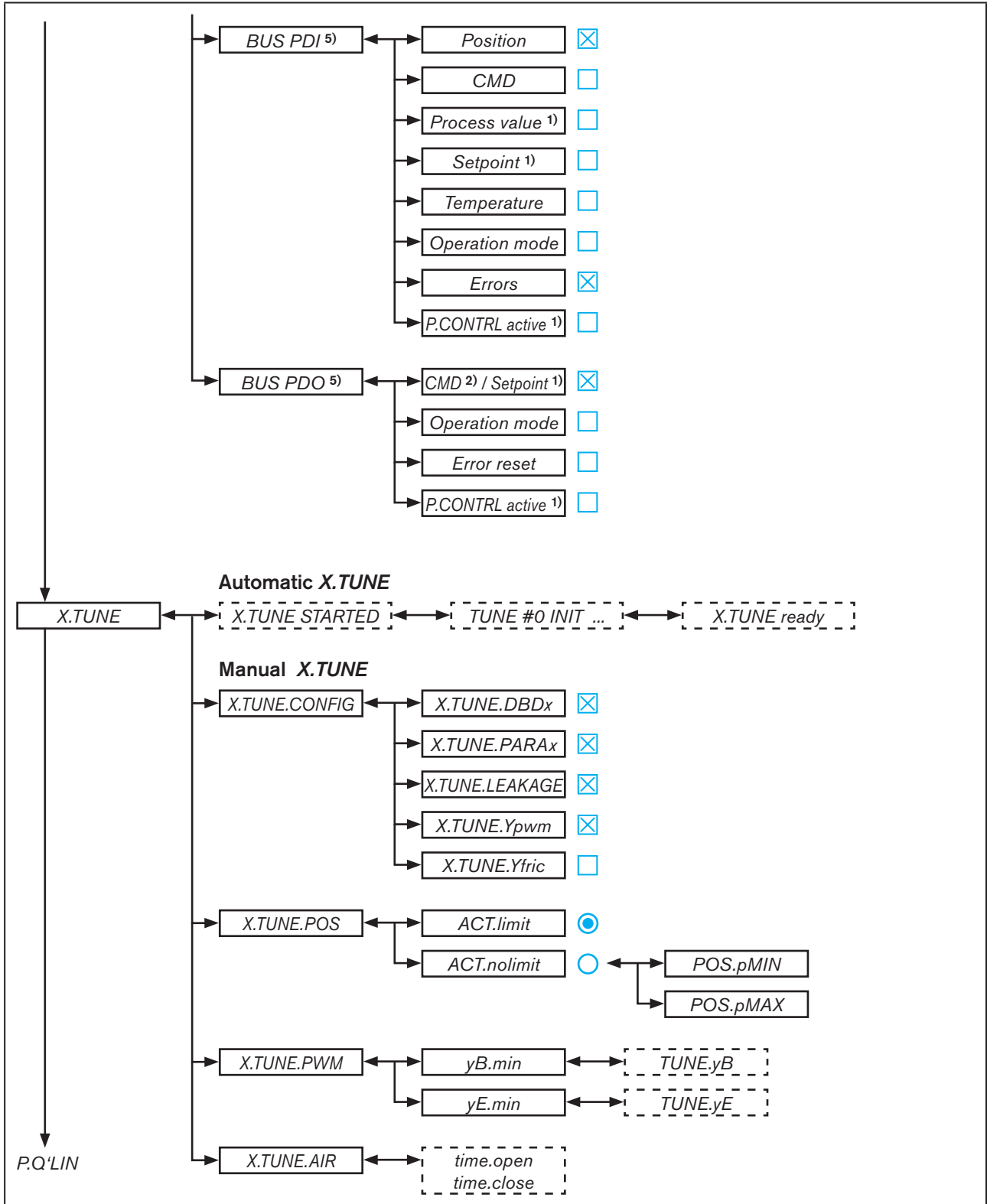
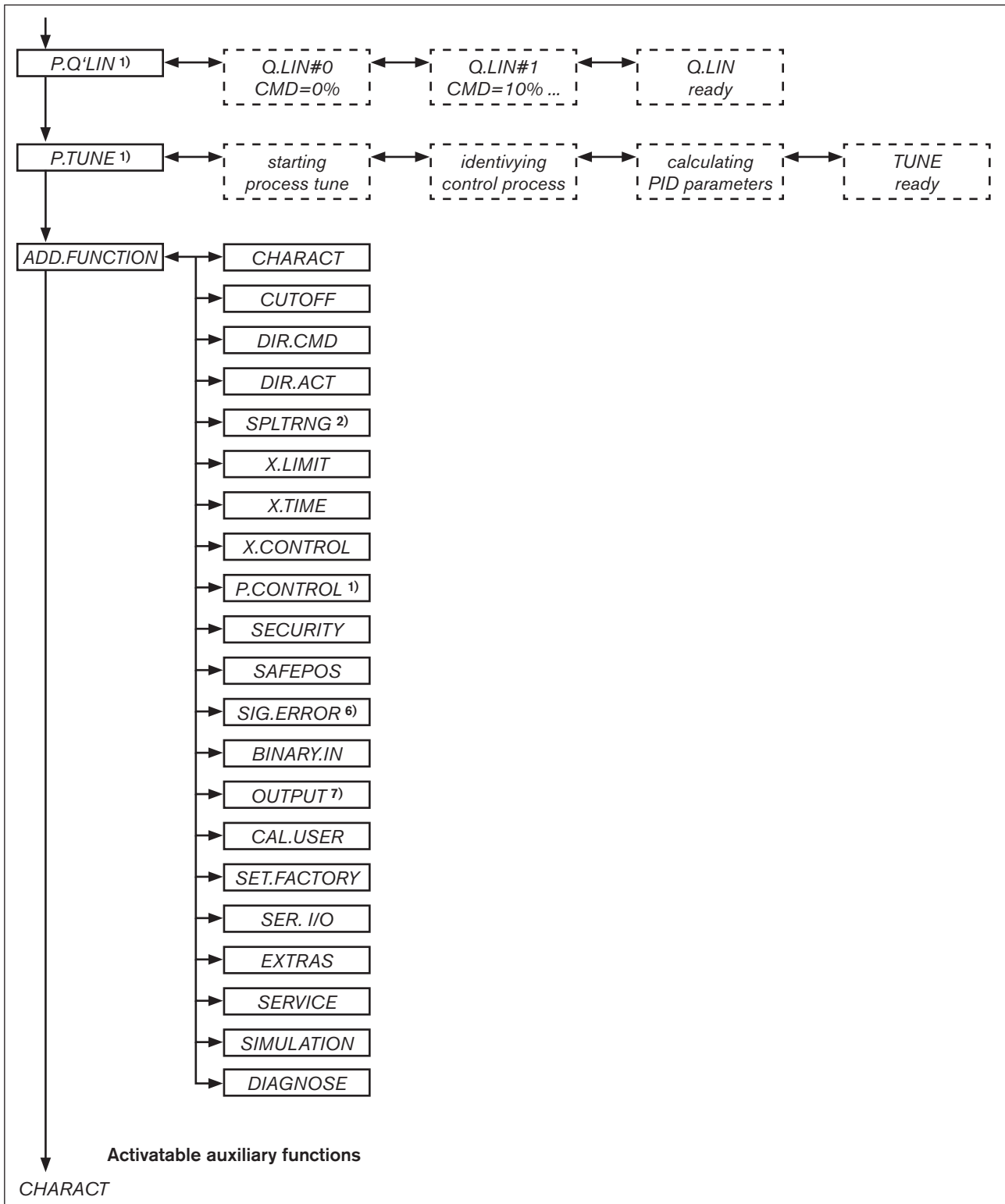


Figure 110: Operating structure - 2

- 1) only process controller Type 8693
- 2) only for position controller mode
- 3) only PROFIBUS DP



MAN 1000108626 EN Version: F Status: RL (released | freigegeben) printed: 20.01.2015

Figure 111: Operating structure - 3

- 1) only process controller Type 8693
- 2) only for position controller mode
- 6) only for signal type 4-20 mA and Pt 100
- 7) Optional. The number of outputs varies depending on the version.

MAN 1000108626 EN Version: F Status: RL (released | freigegeben) printed: 20.01.2015

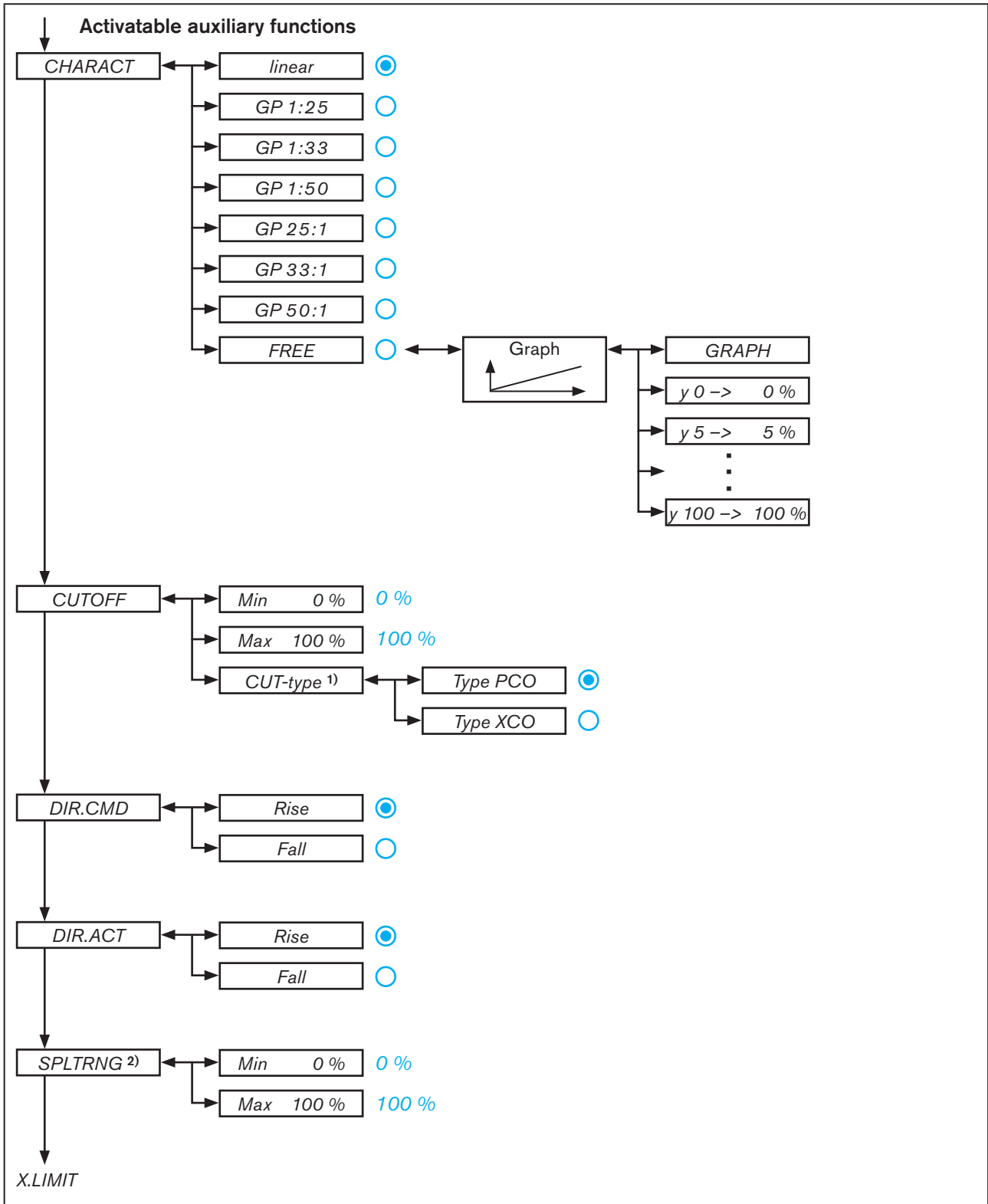


Figure 112: Operating structure - 4

1) only process controller Type 8693
 2) only for position controller mode

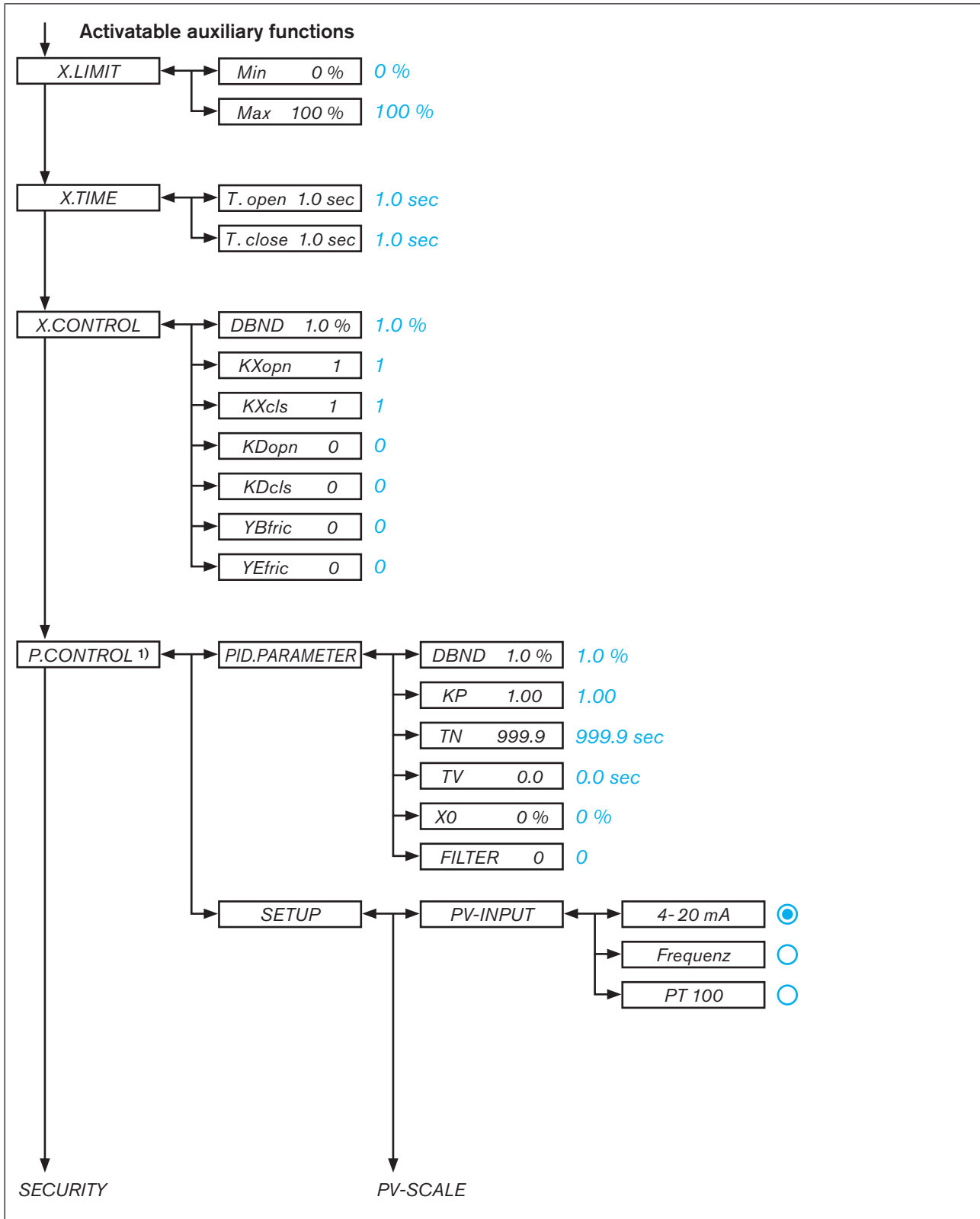


Figure 113: Operating structure - 5

MAN 1000108626 EN Version: F Status: RL (released | freigegeben) printed: 20.01.2015

MAN 1000108626 EN Version: F Status: RL (released | freigegeben) printed: 20.01.2015

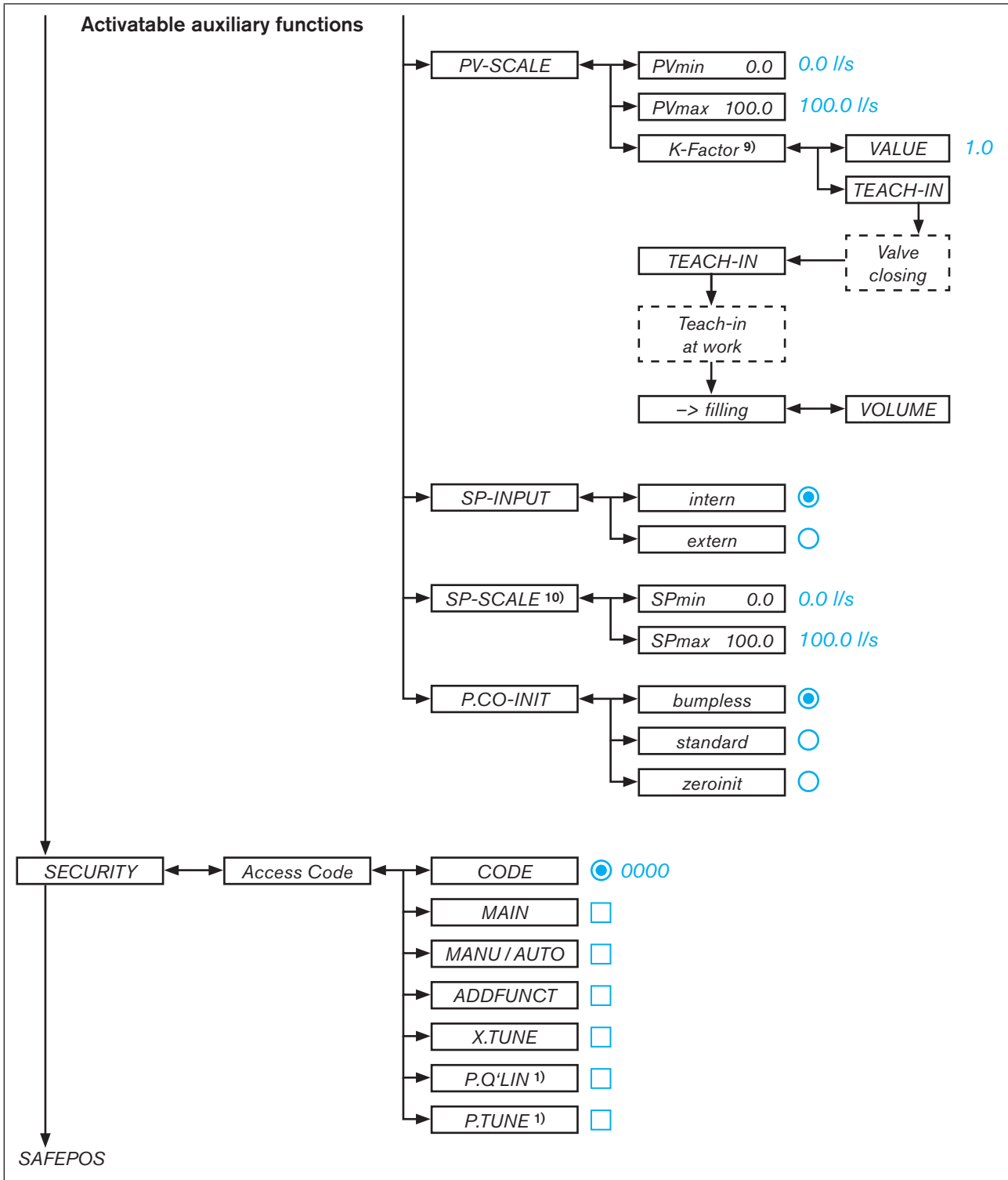


Figure 114: Operating structure - 6

1) only process controller Type 8693

9) only for signal type frequency (P.CONTROL → SETUP → PV-INPUT → Frequenz)

10) Only process controller Type 8693 and for external set-point value default (P.CONTROL → SETUP → SP-INPUT → extern)

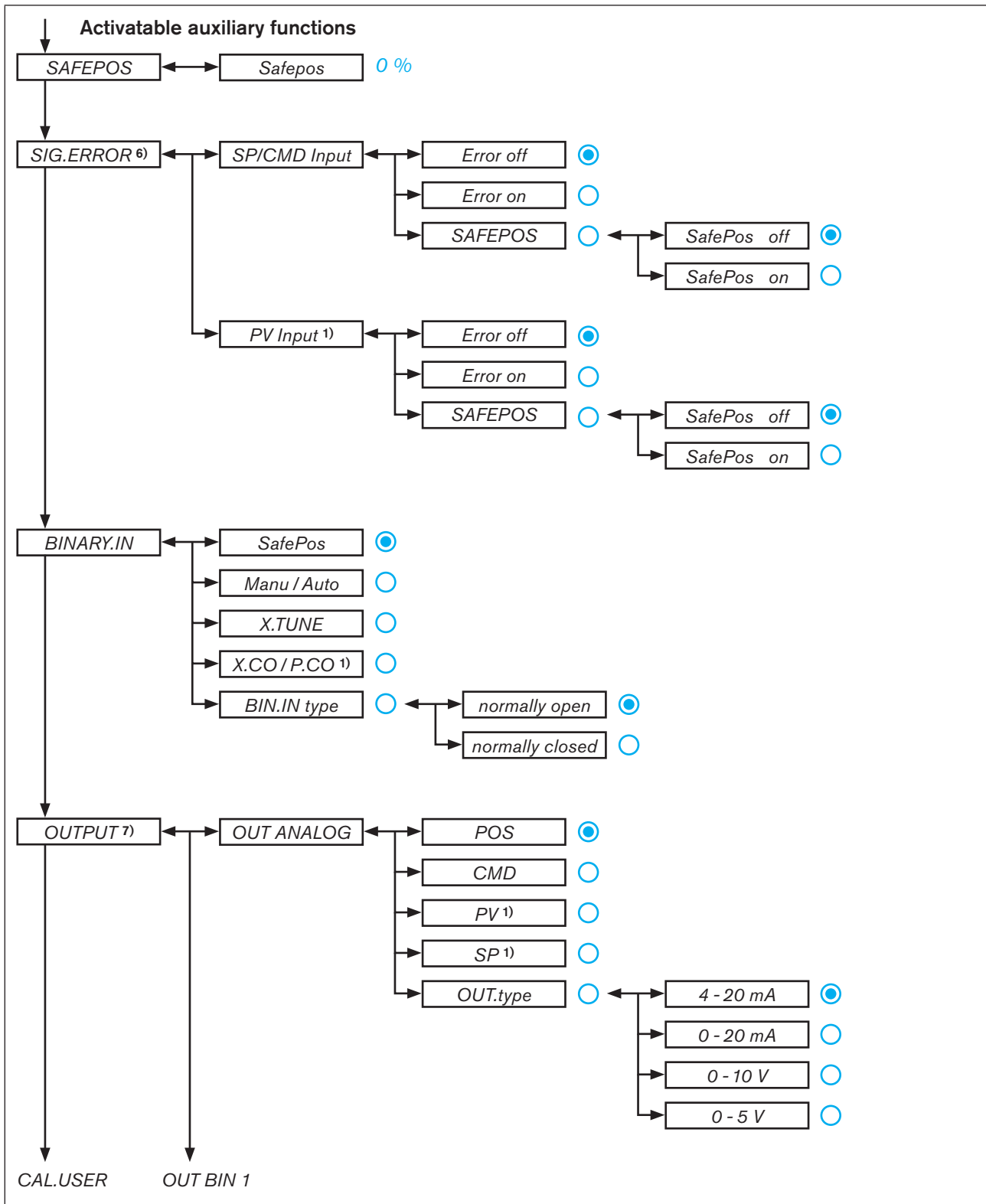


Figure 115: Operating structure - 7

- 1) only process controller Type 8693
- 6) only for signal type 4-20 mA and Pt 100
- 7) Optional. The number of outputs varies depending on the version

MAN 1000108626 EN Version: F Status: RL (released | freigegeben) printed: 20.01.2015

MAN 1000108626 EN Version: F Status: RL (released | freigegeben) printed: 20.01.2015

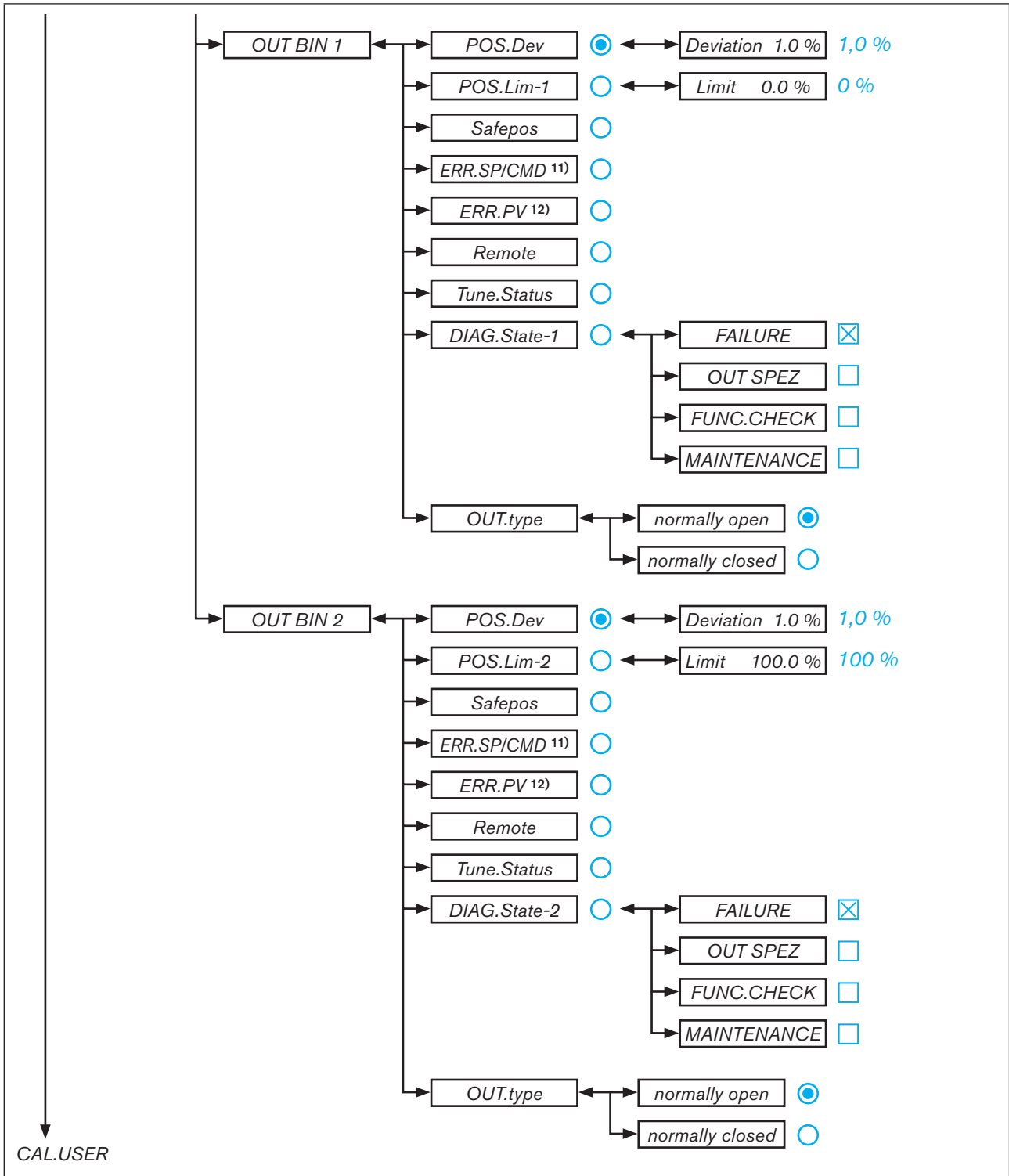


Figure 116: Operating structure - 8

- 11) only if fault detection is activated for the input signal
(SIG.ERROR → SP/CMD Input or PV-Input → Error on)
- 12) Only process controller Type 8693 and if fault detection is activated for the input signal
(SIG.ERROR → SP/CMD Input or PV-Input → Error on)

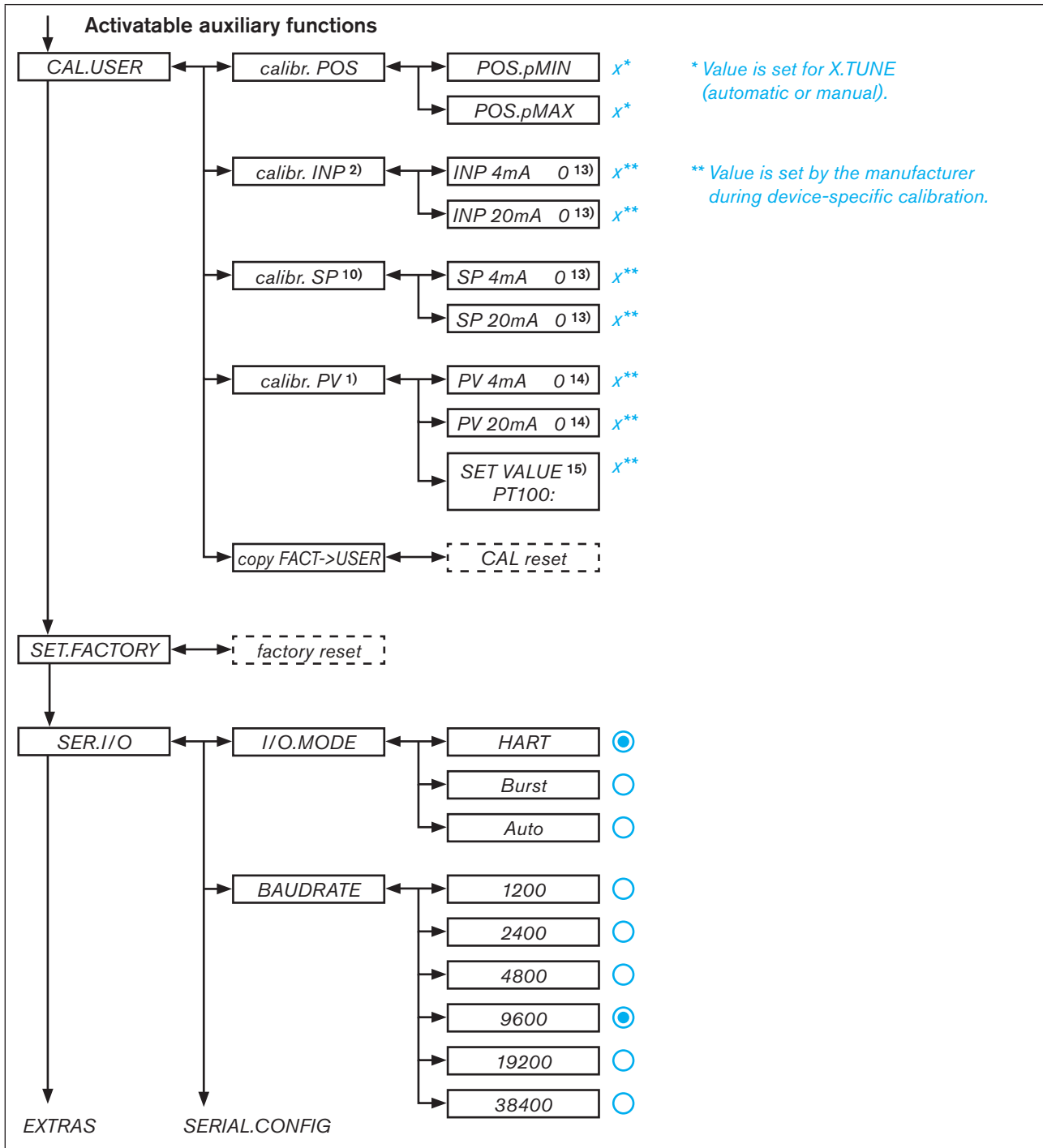


Figure 117: Operating structure - 9

- 1) only process controller Type 8693
- 2) only for position controller mode
- 10) Only process controller Type 8693 and for external set-point value default (P.CONTROL → SETUP → SP-INPUT → extern)
- 13) The signal type is displayed which is selected in the INPUT menu
- 14) Only for signal type 4-20 mA (P.CONTROL → SETUP → PV-INPUT → 4-20 mA)
- 15) Only for circuit with Pt 100 (P.CONTROL → SETUP → PV-INPUT → PT 100)

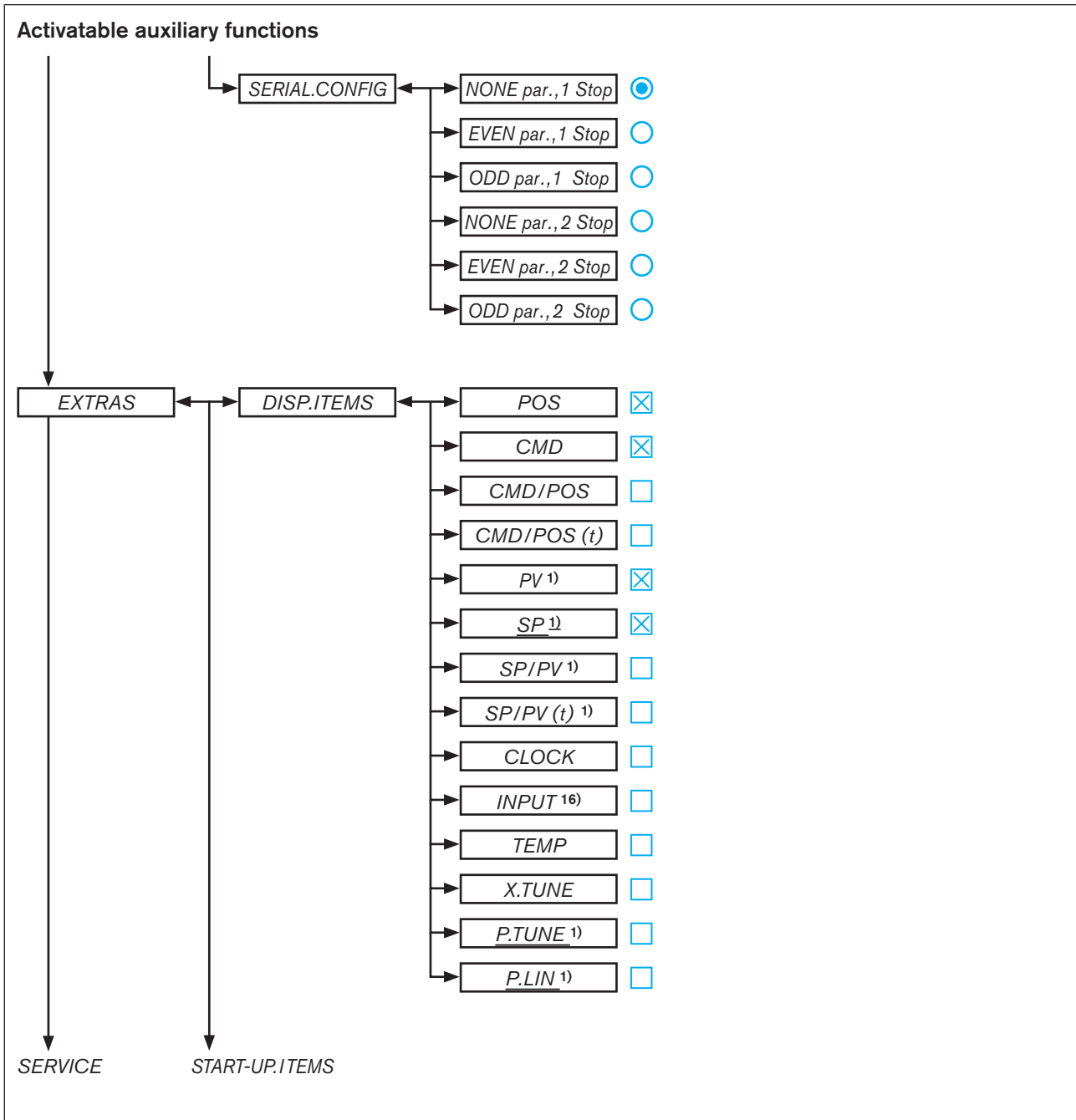


Figure 118: Operating structure- 10

MAN 1000108626 EN Version: F Status: RL (released | freigegeben) printed: 20.01.2015

1) only process controller Type 8693
 16) nicht bei Feldbus

MAN 1000108626 EN Version: F Status: RL (released | freigegeben) printed: 20.01.2015

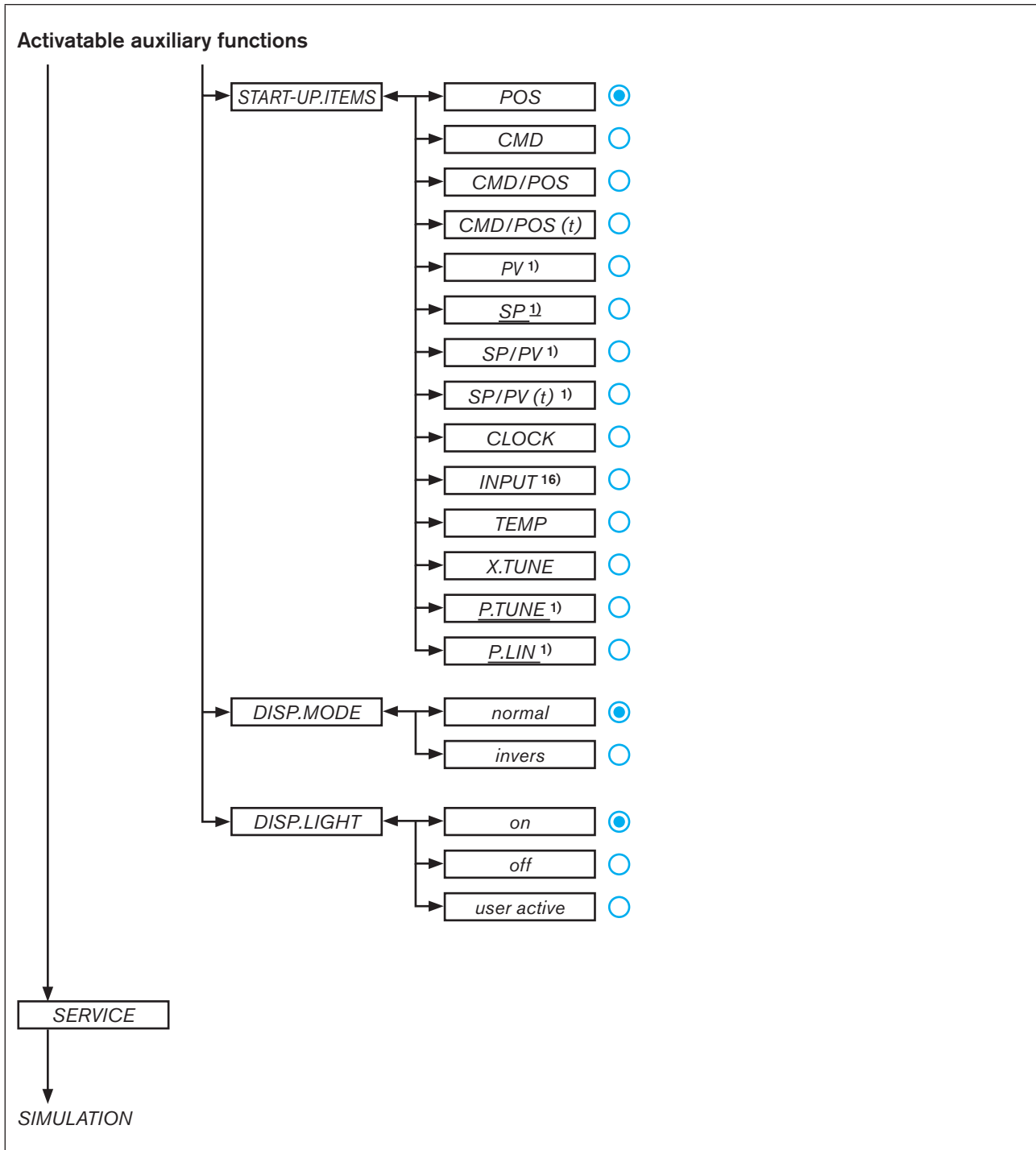
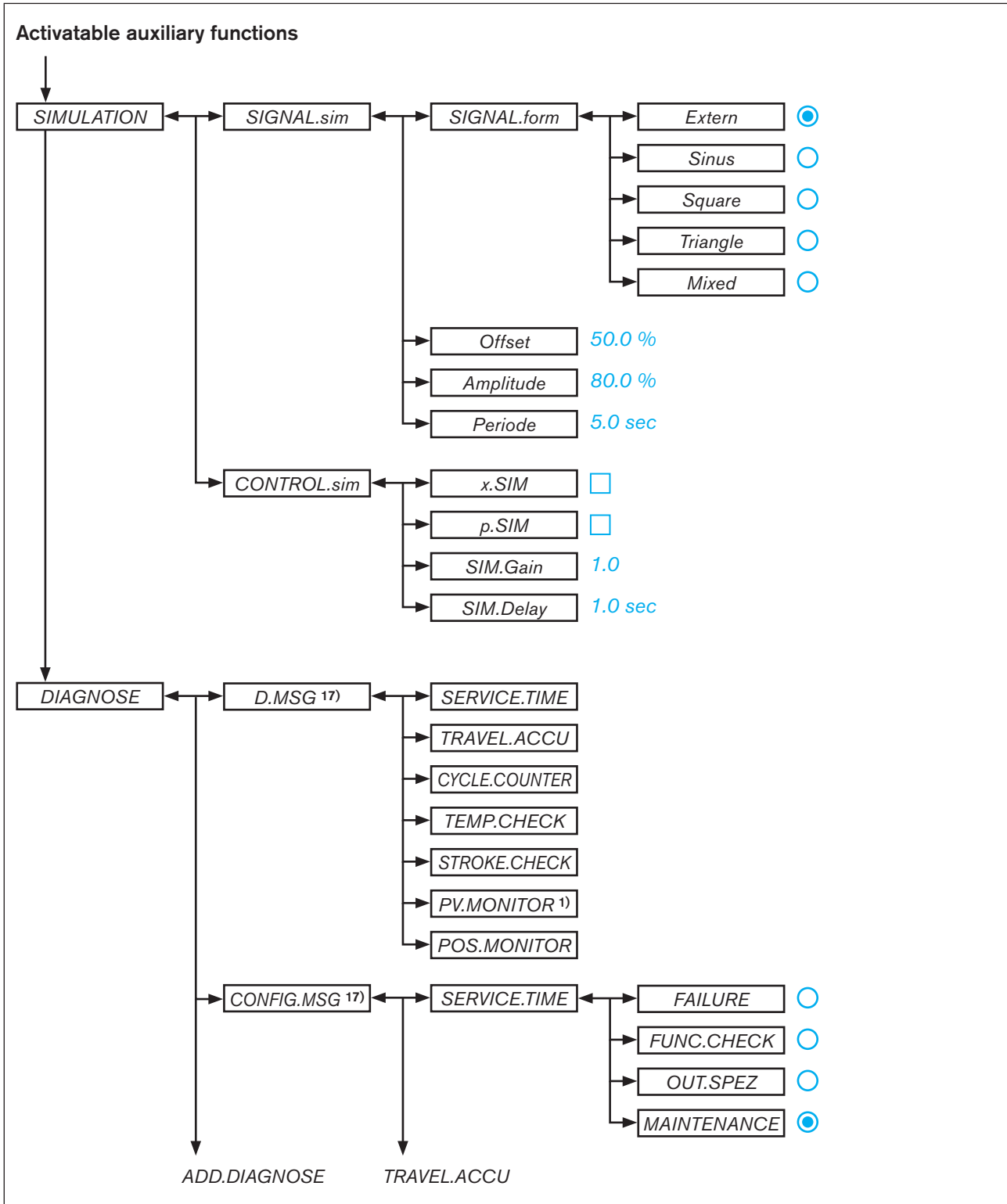


Figure 119: Operating structure - 11

1) only process controller Type 8693

16) not for field bus



MAN 1000108626 EN Version: F Status: RL (released | freigegeben) printed: 20.01.2015

Figure 120: Operating structure - 12

1) only process controller Type 8693

17) The submenu lists only the activated diagnosis functions

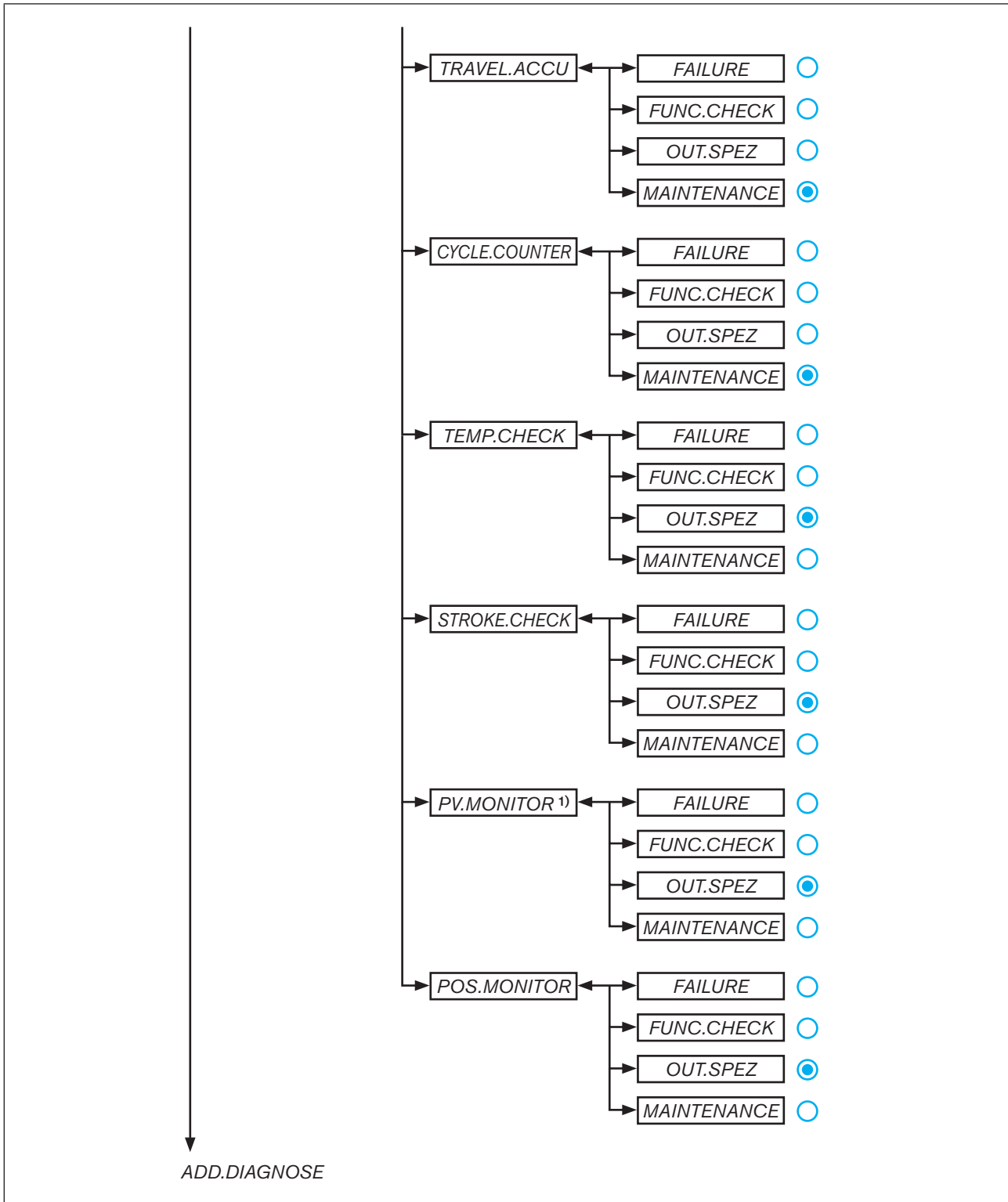


Figure 121: Operating structure - 13

MAN 1000108626 EN Version: F Status: RL (released | freigegeben) printed: 20.01.2015

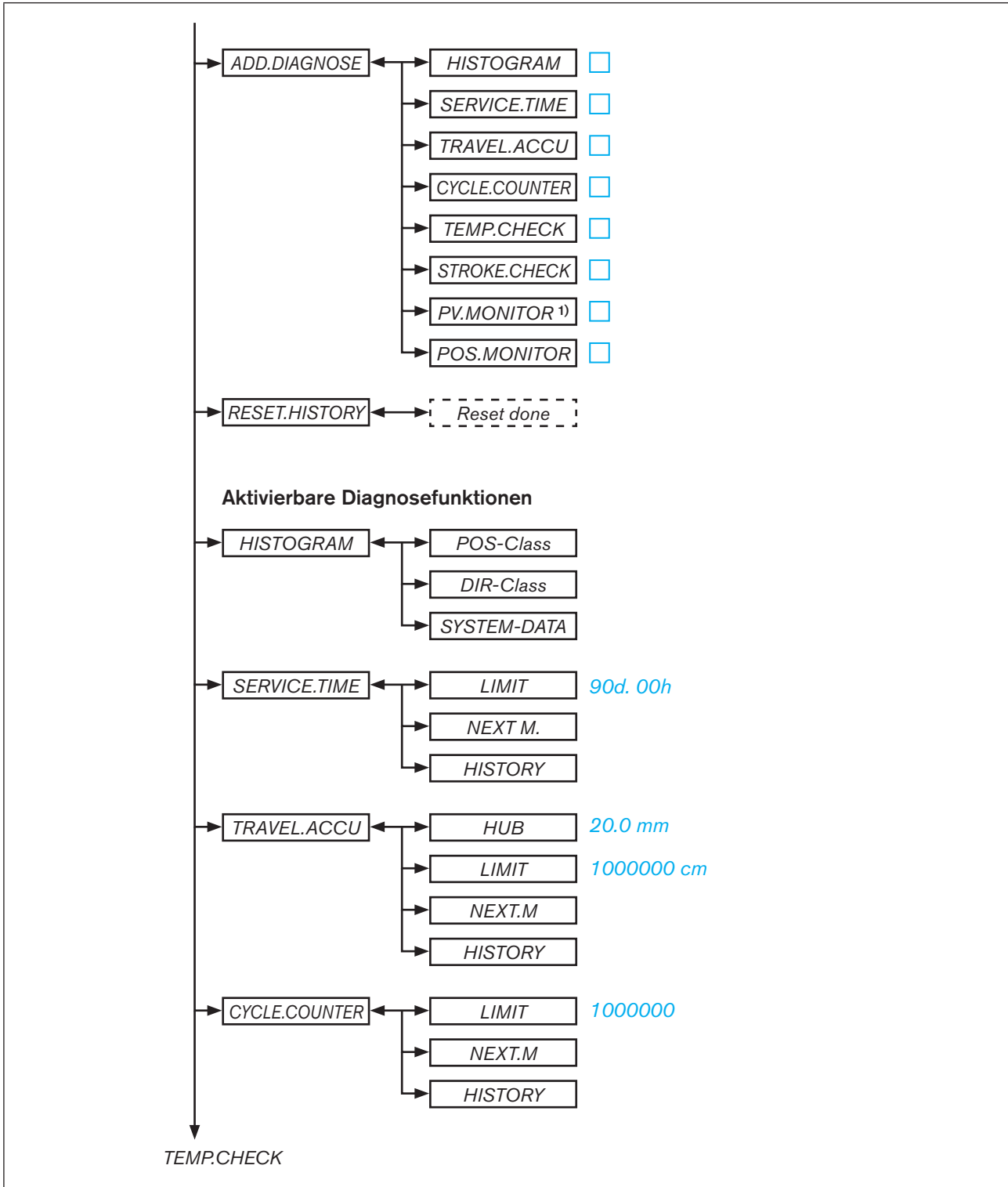


Figure 122: Operating structure - 14

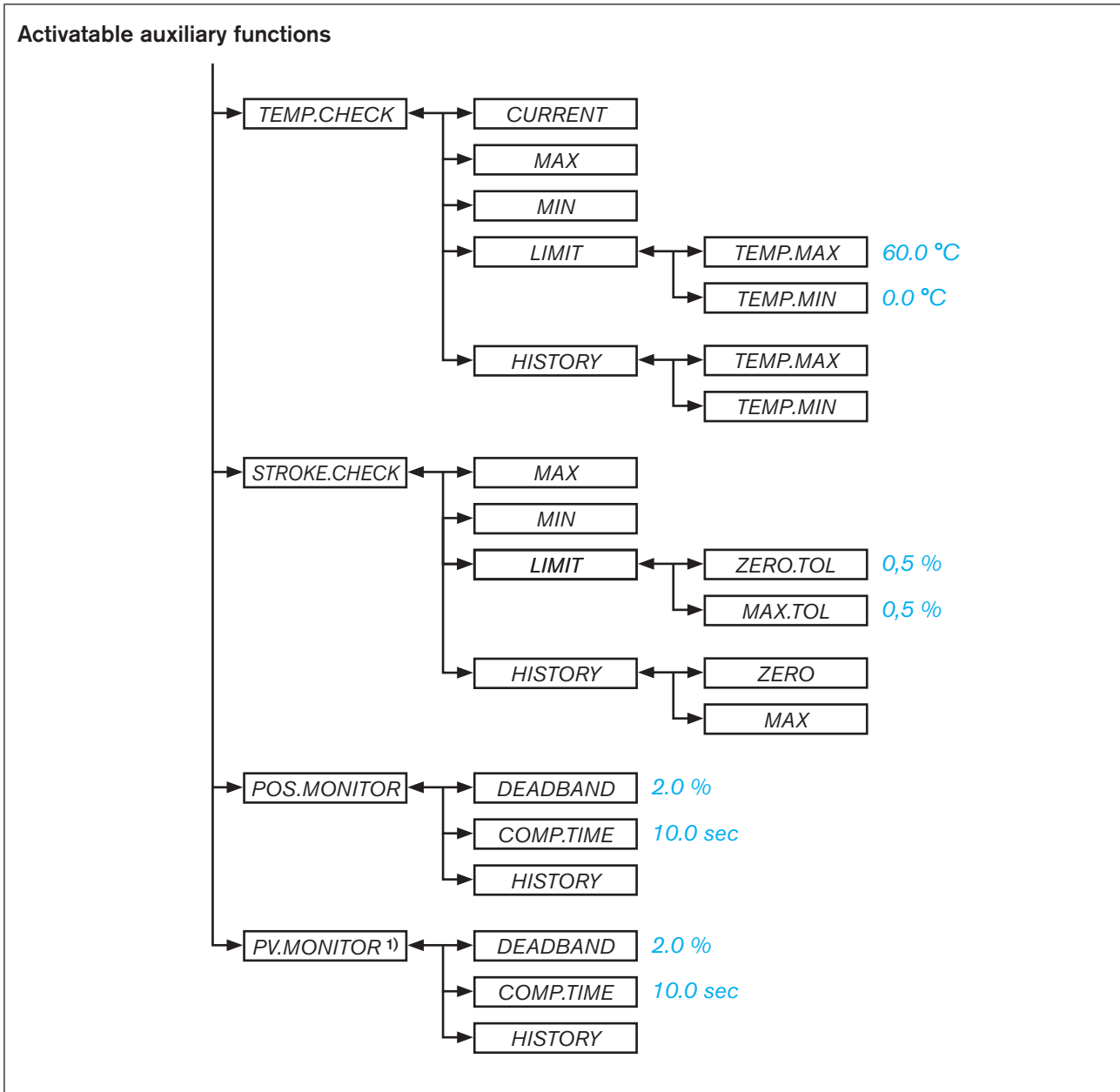


Figure 123: Operating structure - 15

MAN 1000108626 EN Version: F Status: RL (released | freigegeben) printed: 20.01.2015

PROFIBUS DP

CONTENTS

27	DESCRIPTION OF THE PROFIBUS DP.....	194
27.1	Technical data.....	194
27.2	Interfaces	194
27.3	Changing the operating state.....	195
27.4	Safety settings if the bus fails	195
27.5	Bus status display	195
27.6	Differences between the field bus devices and devices without a field bus.....	195
28	ELECTRICAL CONNECTIONS.....	196
28.1	Connection diagram PROFIBUS DP.....	197
28.2	X2 - M12 socket, 5-pole (bus connection).....	197
28.3	X6 - M12 circular connector, 4-pole (operating voltage).....	197
28.4	X5 - M8 circular connector, 4-pole - input signals process actual value (only Type 8693).....	198
29	START-UP PROFIBUS DP.....	199
29.1	Safety instructions	199
29.2	Start-up sequence.....	199
29.3	BUS.COMM – Settings on Type 8692/8693.....	200
29.4	Configuration via the control (PROFIBUS DP Master)	202
29.4.1	Supplementary literature on the configuration of the PROFIBUS DP	202
29.4.2	Configuration of the process values	202
29.5	Configuration with Siemens Step7	205
29.5.1	Example 1 of a positioner (Type 8692): Transfer of set-point and actual value	205
29.5.2	Example 2 of a process controller (Type 8693): Transfer of several process values.....	206

27 DESCRIPTION OF THE PROFIBUS DP

27.1 Technical data

The protocol sequence complies with the standard DIN 19245 Part 3.

GSD file	BUE2C630.GSD
Bitmap files	BUE2C630.BMP
PNO-ID	C630 Hex
Baud rate	Max. 12 mbaud (is automatically set by the Type 8692/8693)
Sync and Freeze mode	Are not supported
Diagnosis telegram	No device-specific diagnosis
Parameter telegram	No user parameters

The process data is configured in the Type 8692/8693 and in the PROFIBUS DP master.

Maximum 10 process values (total *INPUT* and *OUTPUT*) can be transferred.

27.2 Interfaces

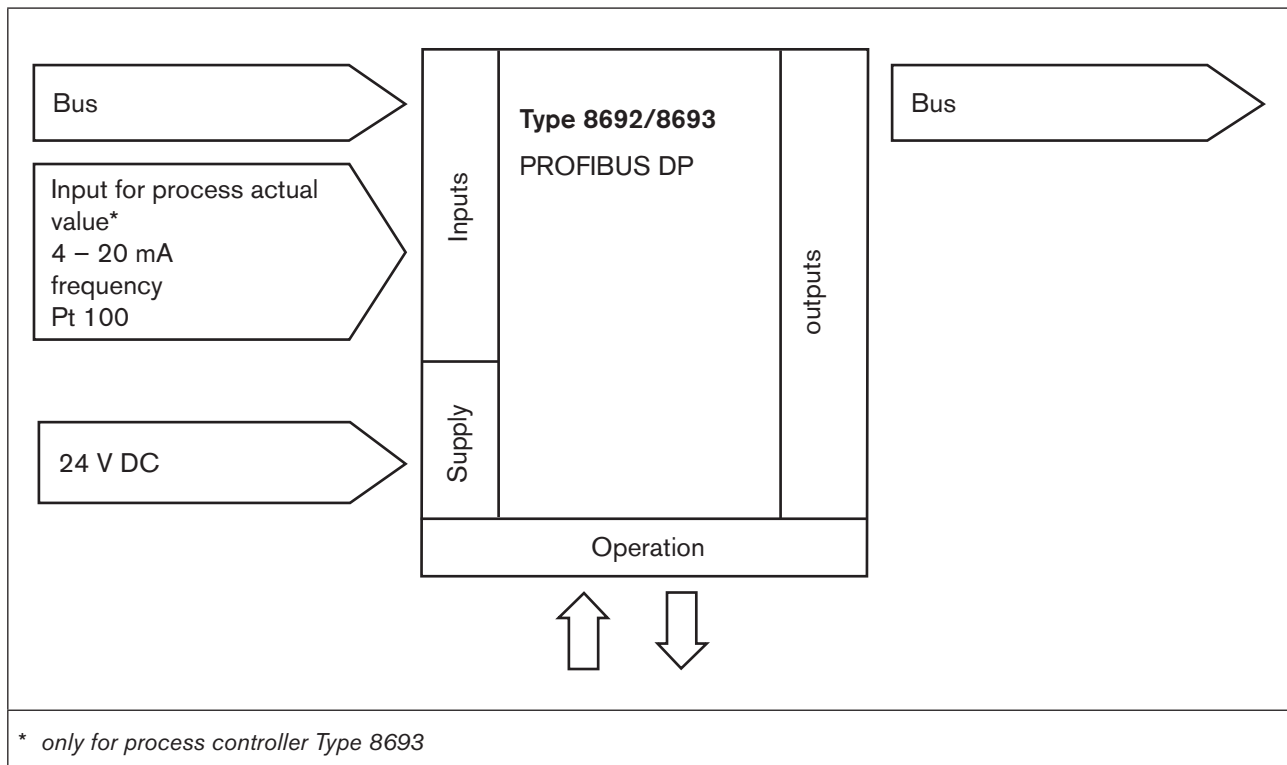


Figure 124: Interfaces PROFIBUS DP

27.3 Changing the operating state

There are two ways of switching between the MANUAL and AUTOMATIC operating states for the PROFIBUS DP:

- Input via the keyboard on the device:
On the process level using the key function **MANU** and **AUTO**.
- The operating state is transferred to the device via the bus (under *PDO MODE*).
In this case switching is no longer possible using the keyboard on the device.

27.4 Safety settings if the bus fails

The position is approached which corresponds to the set-point value last transferred (default setting).

Other setting options (see chapter [“29.3 BUS.COMM – Settings on Type 8692/8693”](#)).

27.5 Bus status display

The bus status is indicated on the display on the device.

Display	Device status	Explanation	Troubleshooting
BUS offline is displayed approx. every 3 seconds	offline	Device is not connected to the bus	<ul style="list-style-type: none"> ▪ Check bus connection including plug assignment. ▪ Check operating voltage and bus connection of the other nodes.

Table 98: Bus status display; PROFIBUS DP

27.6 Differences between the field bus devices and devices without a field bus

The following chapters of these operating instructions are not valid for Type 8692/8693 with PROFIBUS DP.

- Section “Installation” Chapter [“13 Electrical Installation 24 V DC”](#)
- Section “Start-up” Chapter [“22.2 INPUT - Setting the input signal”](#)
- Section “Auxiliary functions” Chapter [“25.2.5 SPLTRNG – Signal split range”](#)

Chapter [“25.2.15 CAL.USER – Calibration of actual value and set-point value”](#)
- Menu option *calibr.INP*, calibration of the position set-point value
- Menu option *calibr.SP*, calibration of the process set-point value

Chapter [“25.2.13 BINARY.IN – Activation of the binary input”](#)

Chapter [“25.2.14 OUTPUT – Configuring the outputs \(option\)”](#)

28 ELECTRICAL CONNECTIONS



DANGER!

Risk of injury due to electrical shock!

- ▶ Before reaching into the device or the equipment, switch off the operating voltage and secure to prevent reactivation!
- ▶ Observe applicable accident prevention and safety regulations for electrical equipment!



WARNING!

Risk of injury from improper installation!

- ▶ Installation may be carried out by authorized technicians only and with the appropriate tools!

Risk of injury from unintentional activation of the system and an uncontrolled restart!

- ▶ Secure system from unintentional activation.
- ▶ Following installation, ensure a controlled restart.

For operation of the device the following must always be connected:

- **X6** - circular connector M12, 4-pole (for operating voltage see "[Table 100: X6 - M12 circular connector, 4-pole \(operating voltage\)](#)") and
- **X2** - socket M12, 5-pole, inversely coded (see "[Table 99: X2 - M12 socket, 5-pole - bus connection, PROFIBUS DP](#)").

Procedure:

- Connect Type 8692/8693 according to the tables.

On the electrical connection housing is a setscrew with nut for connection of the technical earth. (see "[Figure 125: Electrical connection PROFIBUS DP, Type 8692/8693](#)").

- Connect setscrew to a suitable grounding point. To ensure electromagnetic compatibility (EMC), ensure that the cable is as short as possible (max. 30 cm, Ø 1,5 mm²).

When the operating voltage is applied, Type 8692/8693 is operating.

- Now make the required basic settings and adjustments for the positioner/process controller. See chapter "[29.2 Start-up sequence](#)".

NOTE!

Electromagnetic compatibility (EMC) is only ensured if the appliance is connected correctly to an earthing point.

On the outside of the housing is a TE terminal for connection of the technical earth (TE).

- Connect the TE terminal to the earthing point via a shortest possible cable (maximum length 30 cm).

28.1 Connection diagram PROFIBUS DP

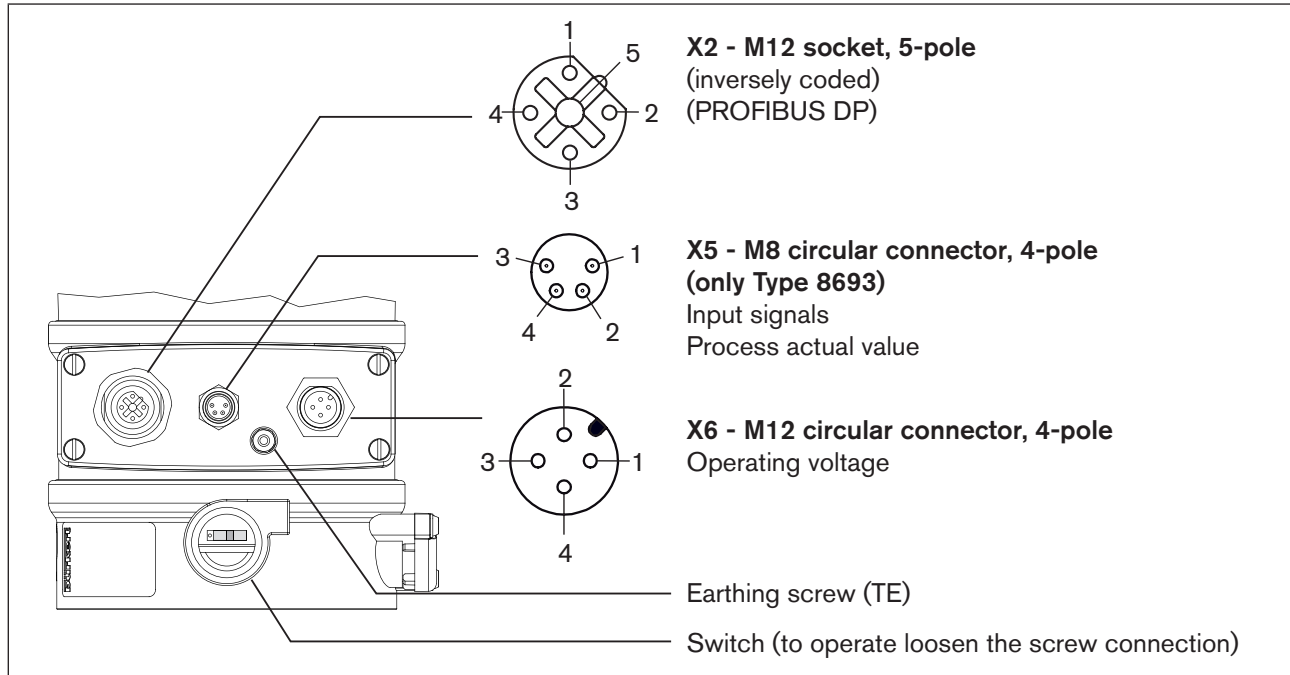


Figure 125: Electrical connection PROFIBUS DP, Type 8692/8693

28.2 X2 - M12 socket, 5-pole (bus connection)

Pin	Configuration	External circuit / Signal level
1	VP+5	Supply the terminating resistors
2	RxD/TxD-N	Received/transmitted data -N, A-line
3	DGND	Data transmission potential (earth to 5 V)
4	RxD/TxD-P	Received/transmitted data -P, B-line
5	Schirm	Shielding / protective earth

Table 99: X2 - M12 socket, 5-pole - bus connection, PROFIBUS DP


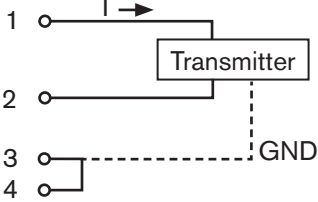




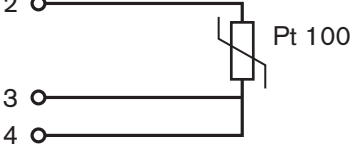
28.3 X6 - M12 circular connector, 4-pole (operating voltage)

Pin	Wire color*	Configuration	On the device side	External circuit / Signal level
1	brown	+24 V		24 V DC \pm 10 % max. residual ripple 10%
2		not used		
3	blue	GND		
4		not used		

* The indicated wire colours refer to the connection cable, part no. 918038, available as an accessory.

Table 100: X6 - M12 circular connector, 4-pole (operating voltage)

28.4 X5 - M8 circular connector, 4-pole - input signals process actual value (only Type 8693)

input type*	Pin	Wire color **	Assignment	Switch ***	On the device side	External circuit
4 ... 20 mA - internally supplied	1 2 3 4	brown white blue black	+24 V supply transmitter Output of transmitter GND (identical with GND operating voltage) Bridge to GND (GND from 3-wire transmitter)	 Switch on left		
4 ... 20 mA - externally supplied	1 2 3 4	brown white blue black	not assigned Process actual + not assigned Process actual -	 Switch on right	2 ○ — 4 ... 20 mA 4 ○ — GND 4 ... 20 mA	
Frequenz - internally supplied	1 2 3 4	brown white blue black	+24 V sensor supply Clock input + Clock input - (GND) not assigned	 Switch on left	1 ○ — +24 V 2 ○ — Clock + 3 ○ — Clock - / GND (identical with GND operating voltage)	
Frequenz - externally supplied	1 2 3 4	brown white blue black	not assigned Clock input + Clock input - not assigned	 Switch on right	2 ○ — Clock + 3 ○ — Clock -	
Pt 100 (see note below) ****	1 2 3 4	brown white blue black	not assigned Process actual 1 (current feed) Process actual 3 (GND) Process actual 2 (compensation)	 Switch on right		

* Can be adjusted via software (see chapter "24.2.1 PV-INPUT – Specifying signal type for the process actual value").
 ** The indicated colors refer to the connection cable available as an accessory (92903474).
 *** The switch is situated under the screw joint (see "Figure 125: Electrical connection PROFIBUS DP, Type 8692/8693", „).

Table 101: X5 - M8 circular connector, 4-pole - input signals process actual value (only Type 8693)



**** For reasons of wire resistance compensation, connect the Pt 100 sensor via 3 wires. Always bridge Pin 3 and Pin 4 on the sensor.

When the operating voltage is applied, the Type 8692/8693 is operating.

→ Now make the required basic settings and actuate the automatic adjustment of the positioner/process controller. The procedure is described in chapter "20 Start-up sequence".

29 START-UP PROFIBUS DP

29.1 Safety instructions



WARNING!

Risk of injury from improper operation!

Improper operation may result in injuries as well as damage to the device and the area around it

- ▶ Before start-up, ensure that the operating personnel are familiar with and completely understand the contents of the operating instructions.
- ▶ Observe the safety instructions and intended use.
- ▶ Only adequately trained personnel may start up the equipment/the device.



Before start-up, carry out pneumatic, fluid and electrical installation of Type 8692/8693 and of the valve. For a description see chapters [“12”](#) and [“28”](#).

29.2 Start-up sequence

For start-up of Type 8692/8693 PROFIBUS DP the following basic settings are required:


Device type	Sequence	Type of basic setting	Setting via	Description in chapter
8692 and 8693	1	<p>Enter the operating mode of the valve actuator.</p> <p> Generally not required for the initial start-up! The operating mode of the actuator has been preset in the factory.</p>	ACTUATOR	“22.1”
8692 and 8693	1	Adjust device to the local conditions	X.TUNE	“22.3”
For 8693 only (Process control)	2	Activate process controller.	ADD.FUNCTION	“23”
8692 and 8693	3	Settings on Type 8692/8693: Input device address.	BUS.COMM	“29.3”
	4	Activate or deactivate safety position.		
8692 and 8693	5	Configuration via the control (PROFIBUS DP Master):	PROFIBUS DP Master by means of GSD file and special software	“29.4”
		Configuration of the process values 1. PDI: Process data input 2. PDO: Process data output.		

Table 102: Start-up sequence for PROFIBUS DP

29.3 BUS.COMM – Settings on Type 8692/8693

Set the following menu options in the *BUS.COMM* menu for start-up of the PROFIBUS DP:

Address 0 Enter a device address (value between 0 and 126)

BUS FAIL Activate or deactivate approach of the safety position










Selection **SafePos off** – The actuator remains in the position which corresponds to the set-point value last transferred (default setting).

Selection **SafePos on** – If there is a fault in the bus communication, the behavior of the actuator depends on the activation of the *SAFEPOS* auxiliary function. See chapter [“25.2.11 SAFEPOS – Input the safety position”](#).

SAFEPOS activated: The actuator moves to the safety position which is specified in the *SAFEPOS* auxiliary function.

SAFEPOS deactivated: The actuator moves to the safety end position which it would assume if the electrical and pneumatic auxiliary power failed. See chapter [“10.9 Safety end positions after failure of the electrical or pneumatic auxiliary power”](#).

Procedure:

Key	Action	Description
MENU	Press  for approx. 3 s	Switching from process level ⇔ setting level.
▲ / ▼	Select <i>BUS.COMM</i>	Selection in the main menu (MAIN).
ENTER	Press 	The submenu options for basic settings can now be selected.
Setting device address		
▲ / ▼	Select <i>Address</i>	
INPUT	Press 	The input screen is opened.
▲ / ▼	+ Increase value - Reduce value	Enter a device address (value between 0 and 126).
OK	Press 	Return to <i>BUS.COMM</i> .
Deactivating / activating safety position		
▲ / ▼	Select <i>BUS FAIL</i>	
ENTER	Press 	The menu options for deactivating and activating the safety position are displayed.
▲ / ▼	Select menu option	SafePos off = deactivated SafePos on = activated
SELEC	Press 	The selection is now marked by a filled circle <input checked="" type="radio"/> .
EXIT	Press 	Return to <i>BUS.COMM</i> .
EXIT	Press 	Return to the main menu (MAIN).
EXIT	Press 	Switching from setting level ⇔ process level.

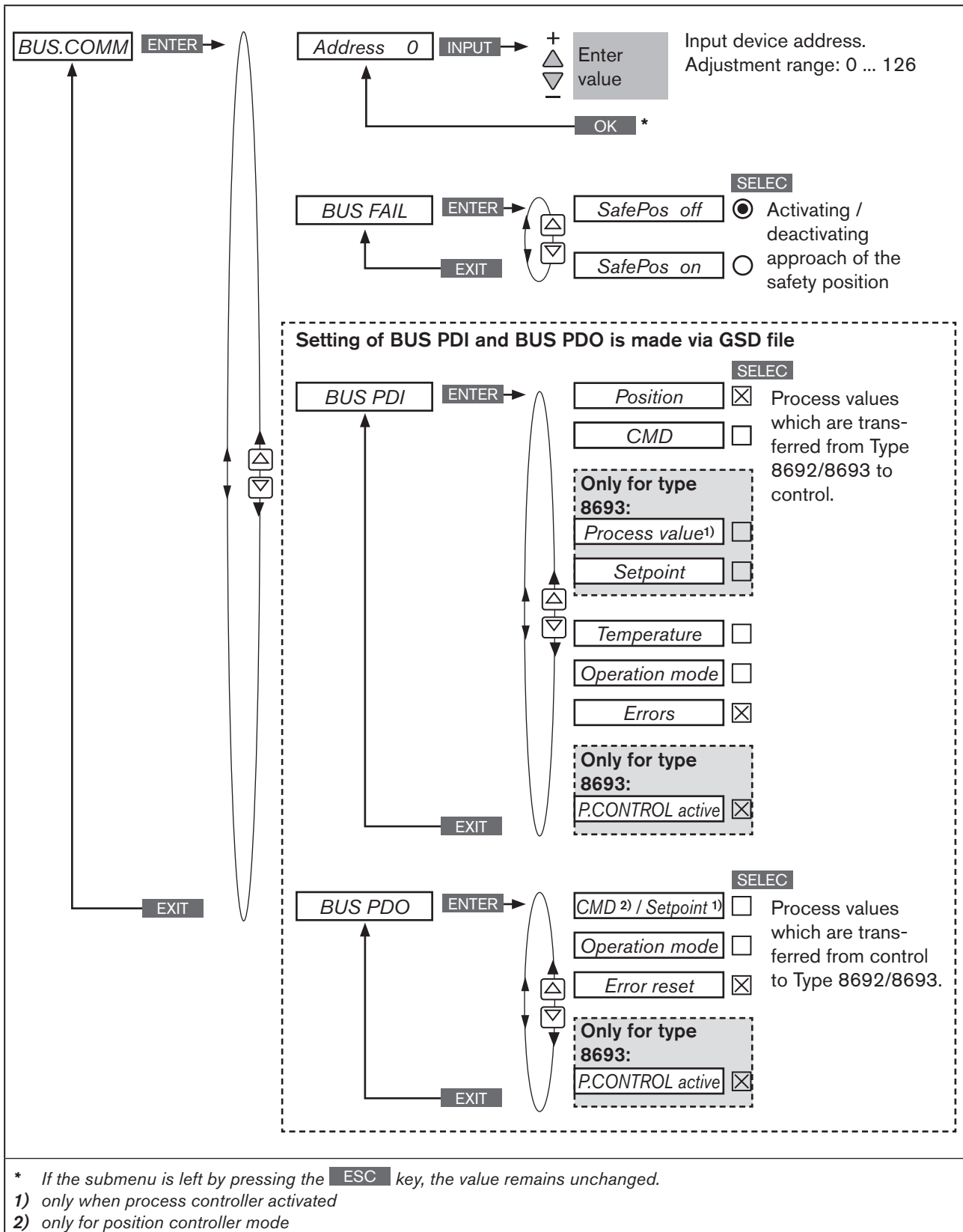


Figure 126: Operating structure - BUS.COMM; PROFIBUS DP

29.4 Configuration via the control (PROFIBUS DP Master)

The configuration requires the following components:

- Software suitable for the configuration. For example Step7 from Siemens A brief description of this can be found in the following chapter "[29.5 Configuration with Siemens Step7](#)".
- GSD file (download from the Bürkert homepage:)

29.4.1 Supplementary literature on the configuration of the PROFIBUS DP

More detailed information can be found in the supplementary instructions on the Bürkert homepage:

- „Configuration on the PROFIBUS DP by means of GSD file“
www.burkert.com → Type 8692 or Type 8693 → Config. PROFIBUS by GSD-file

29.4.2 Configuration of the process values

→ The PDI (Process Data Input) input first.

PDI: Process Data Input (from the Type 8692/8693 to the controller)

Name	Description	Identifier
<i>PDI:POS</i>	Actual position (position) Actual value of positioner as ‰. Value range 0 – 1000. Values < 0 or > 1000 are possible if e.g. Autotune has not run through correctly.	GSD file: <i>PDI:POS</i> Identifier (HEX): 41, 40, 00
<i>PDI:CMD</i>	Set-point position (command) Set-point value of positioner as ‰. Value range 0 – 1000.	GSD file: <i>PDI:CMD</i> Identifier (HEX): 41, 40, 01
<i>PDI:PV</i> <i>PDI:SP</i>	Process actual value (process value) Actual value of process controller in physical unit (as set in the menu <i>P.CONTROL</i> → <i>SETUP</i> → <i>PV-INPUT</i> or <i>PV-SCALE</i>), max. value range -999 – 9999, depending on internal scaling Process set-point value (setpoint) Set-point value of process controller in physical unit (as set in the menu <i>P.CONTROL</i> → <i>SETUP</i> → <i>SP-INPUT</i> or <i>SP-SCALE</i>), max. value range -999 – 9999, depending on internal scaling	GSD file: <i>PDI:PV</i> Identifier (HEX): 41, 40, 02 GSD file: <i>PDI:SP</i> Identifier (HEX): 41, 40, 03
<i>PDI:TEMP</i>	Device temperature (temperature) Temperature of 0.1 °C is measured on the CPU board by the sensor, Value range -550 (-55 °C) – +1250 (+125 °C)	GSD file: <i>PDI:TEMP</i> Identifier (HEX): 41, 40, 04

Name	Description	Identifier
<i>PDI:MODE</i>	Operating state (operation mode) Operating state: 0: <i>AUTO</i> 1: <i>MANU</i> 2: <i>X.TUNE</i> 9: <i>P.QLIN</i> 10: <i>P.TUNE</i> 12: <i>BUSSAFEPOS</i>	GSD file: <i>PDI:MODE</i> Identifier (HEX): 41, 00, 05
<i>PDI:ERR</i>	Error Indicates the number of the process value (output) which was not written. The value is retained until it is deleted with <i>PDO:ERR</i> . HEX 14 <i>PDO:CMD / SP</i> 16 <i>PDO:MODE</i>	GSD file: <i>PDI:ERR</i> Identifier (HEX): 41, 00, 06
<i>PDI:PCONact</i>	0: Positioner 1: Process controller	GSD file: <i>PDI:PCONact</i> Identifier (HEX): 41, 00, 0A

Table 104: Process Data Input, PROFIBUS DP



PDI:PV and *PDI:SP* can be selected for Type 8693 (process controller) only and are beneficial only when process controller activated.

PDI:PCONact can be selected for Type 8693 (process controller) only.

→ Then the PDO (Process Data Output) input.

PDO: Process Data Output (from the controller to the Type 8692/8693)

Name	Description	Identifier
<i>PDO:CMD/SP</i>	for positioner Type 8692: Set-point position (input) Set-point value of positioner as ‰. Value range 0 – 1000 If the value is too small or too large, the last valid value is used and is indicated in <i>ERR</i> with HEX 14. for process controller Type 8693: Process set-point value (setpoint) Set-point value of process controller in physical unit (as set in the menu <i>P.CONTROL</i> → <i>SETUP</i> → <i>SP-INPUT</i> or <i>SP-SCALE</i>), max. value range -999 – 9999, depending on internal scaling. If the value is too small or too large, the last valid value is used and is indicated in <i>ERR</i> with HEX 14.	GSD file: <i>PDO:CMD/SP</i> Identifier (HEX): 81, 40, 14

Name	Description	Identifier
<i>PDO:MODE</i>	Operating state (operation mode) Value range 0, 1 or 12: 0: <i>AUTO</i> / 1: <i>MANU</i> / 12: <i>BUSSAFEPOS</i> If the value is too small or too large, the last valid value is used and is indicated in <i>ERR</i> with HEX 16.	GSD file: <i>PDO:MODE</i> Identifier (HEX): 81, 00, 16
<i>PDO:ERR</i>	Reset error display If the value > 0, <i>ERR</i> is reset	GSD file: <i>PDO:ERR</i> Identifier (HEX): 81, 00, 17
<i>PDO:CONact</i>	0: Positioner 1: Process controller	GSD file: <i>PDO:CONact</i> Identifier (HEX): 81, 00, 19

Table 105: *Process Data Output, PROFIBUS DP*

29.5 Configuration with Siemens Step7

29.5.1 Example 1 of a positioner (Type 8692): Transfer of set-point and actual value

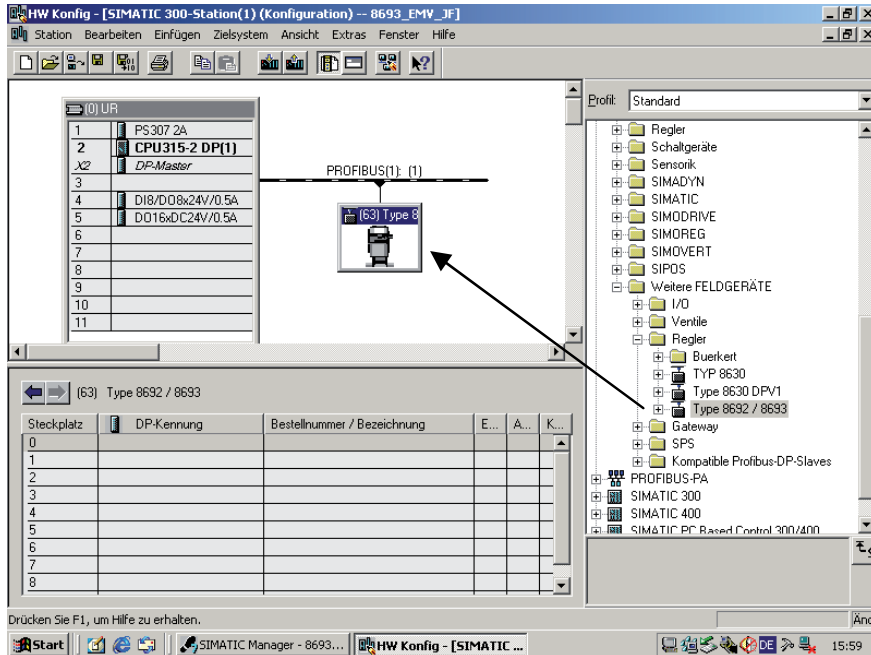


Figure 127: ScreenShot PROFIBUS DP

→ Pull the slave Type 8692 / 8693 onto the bus line with drag-and-drop.

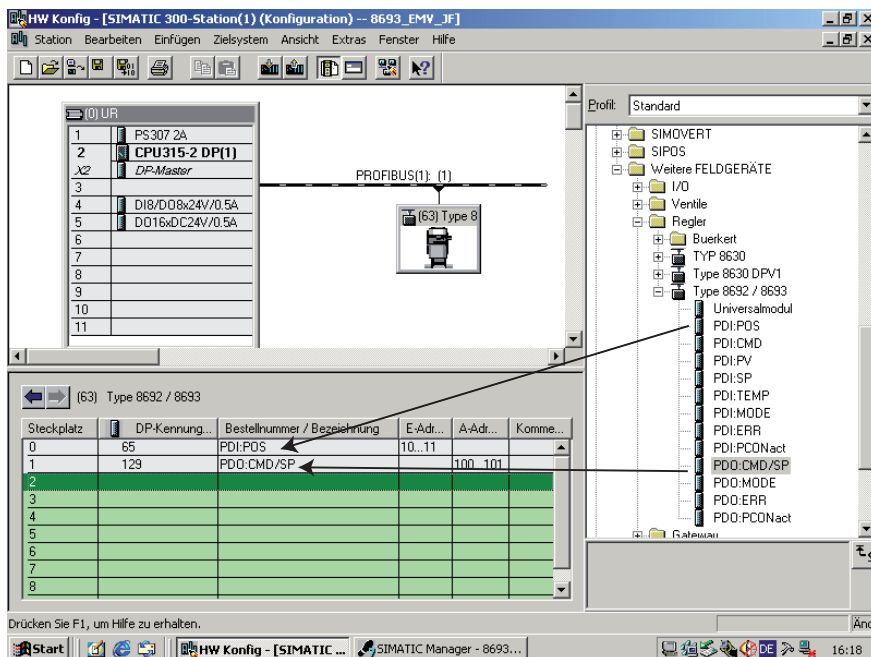


Figure 128: ScreenShot positioner

→ Pull the modules PDI:POS and PDO:CMD/SP into the slave Type 8692 / 8693 with drag-and-drop.

29.5.2 Example 2 of a process controller (Type 8693): Transfer of several process values

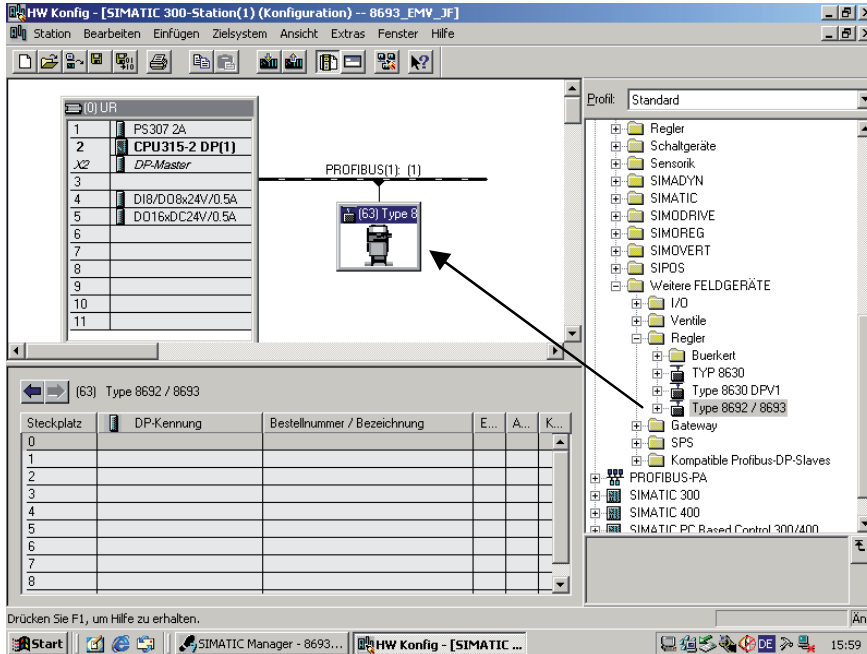


Figure 129: ScreenShot PROFIBUS DP

→ Pull the slave Type 8692 / 8693 onto the bus line with drag-and-drop.

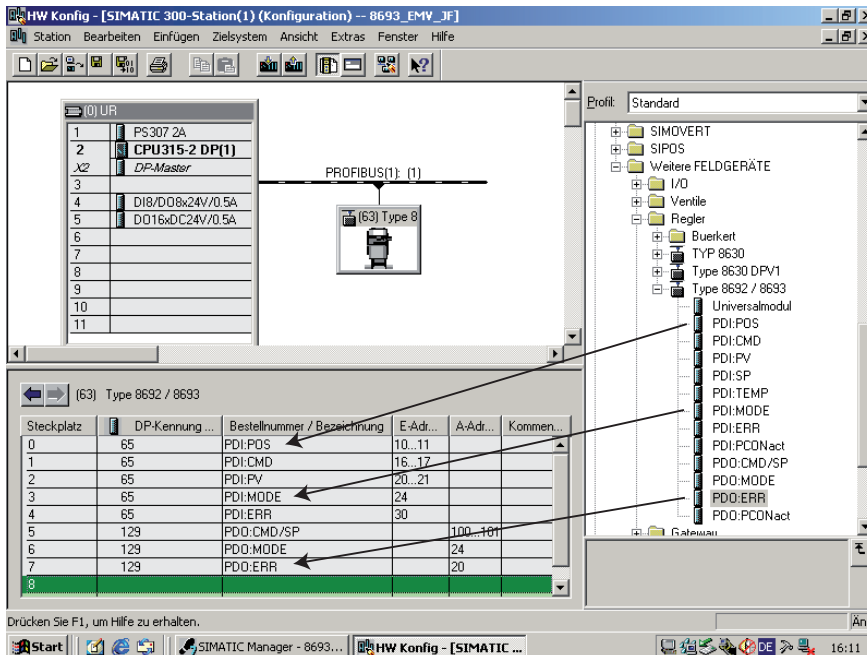


Figure 130: ScreenShot process controller

→ Pull the modules into the slave Type 8692 / 8693 with drag-and-drop.

DeviceNet

CONTENTS

30	DESCRIPTION	208
	30.1 Explanation of term DeviceNet.....	208
	30.2 Technical data.....	208
	30.3 Interfaces	209
	30.4 Safety settings if the bus fails	209
	30.5 Bus status display	210
	30.6 Differences between the field bus devices and devices without a field bus.....	211
31	ELECTRICAL CONNECTIONS.....	212
	31.1 Connection diagram DeviceNet, Type 8692/8693	213
	31.2 X3 - M12 circular connector, 5-pole (bus connection)	213
	31.3 X6 - M12 circular connector, 4-pole (operating voltage).....	213
	31.4 X5 - M8 circular connector, 4-pole - input signals process actual value (only Type 8693).....	214
	31.5 Terminating circuit for DeviceNet systems	215
	31.6 Network topology of a DeviceNet system.....	215
32	START-UP DEVICENET.....	216
	32.1 Safety instructions	216
	32.2 Start-up sequence.....	216
	32.3 <i>BUS.COMM</i> – Settings on Type 8692/8693.....	217
	32.4 Configuration of the process data.....	219
	32.4.1 Static input assemblies	219
	32.4.2 Static output assemblies	221
	32.5 Configuration example 1.....	222
	32.5.1 Installation of the EDS file	222
	32.5.2 Address assignment.....	222
	32.5.3 Offline parameterization of the Device	223
	32.5.4 Online parameterization of the Device	224
	32.6 Configuration example 2.....	225
	32.6.1 Setting up the process image (Mapping).....	226

30 DESCRIPTION

30.1 Explanation of term DeviceNet

DeviceNet

- The DeviceNet is a field bus system which is based on the CAN protocol (Controller Area Network). It enables actuators and sensors (slaves) to be networked with higher-level controllers (master).
- The Type 8692/8693 in the DeviceNet is a slave device according to the Predefined Master/Slave Connection Set stipulated in the DeviceNet specification. Polled I/O, Bit Strobed I/O and Change of State (COS) are supported as an I/O connection variant.
- With DeviceNet it is necessary to differentiate between cyclical or event-driven high-priority process messages (I/O Messages) and acyclical low-priority management messages (Explicit Messages).
- The protocol process conforms to the **DeviceNet specification Release 2.0**.

30.2 Technical data

EDS file	BUER8692.EDS
Icons	BUER8692.ICO
Baud rate	125 kbit/s, 250 kbit/s, 500 kbit/s (can be adjusted by pressing operator keys on the device or via network); Factory setting 125 kBit/s
Address	0 – 63; (can be adjusted by pressing operator keys on the device or via network); Factory setting 63
Process data	7 static input assemblies (Input: from the Type 8692/8693 to the DeviceNet-Master/Scanner) 4 static output assemblies

Total line length according to DeviceNet specification

(Total line length = total of all trunk and drop lines)

Baud rate	Maximum total line length	
	Thick cable	Thin cable
125 kbaud	500 m	100 m for all baud rates
250 kbaud	250 m	
500 kbaud	100 m	

Table 106: DeviceNet; total line length

Drop line length (Drop Lines)

Baud rate	Length of the drop lines	
	Maximum length	Maximum total length Drop lines in the network
125 kbaud	6 m for all baud rates	156 m
250 kbaud		78 m
500 kbaud		39 m

Table 107: DeviceNet; drop line length

30.3 Interfaces

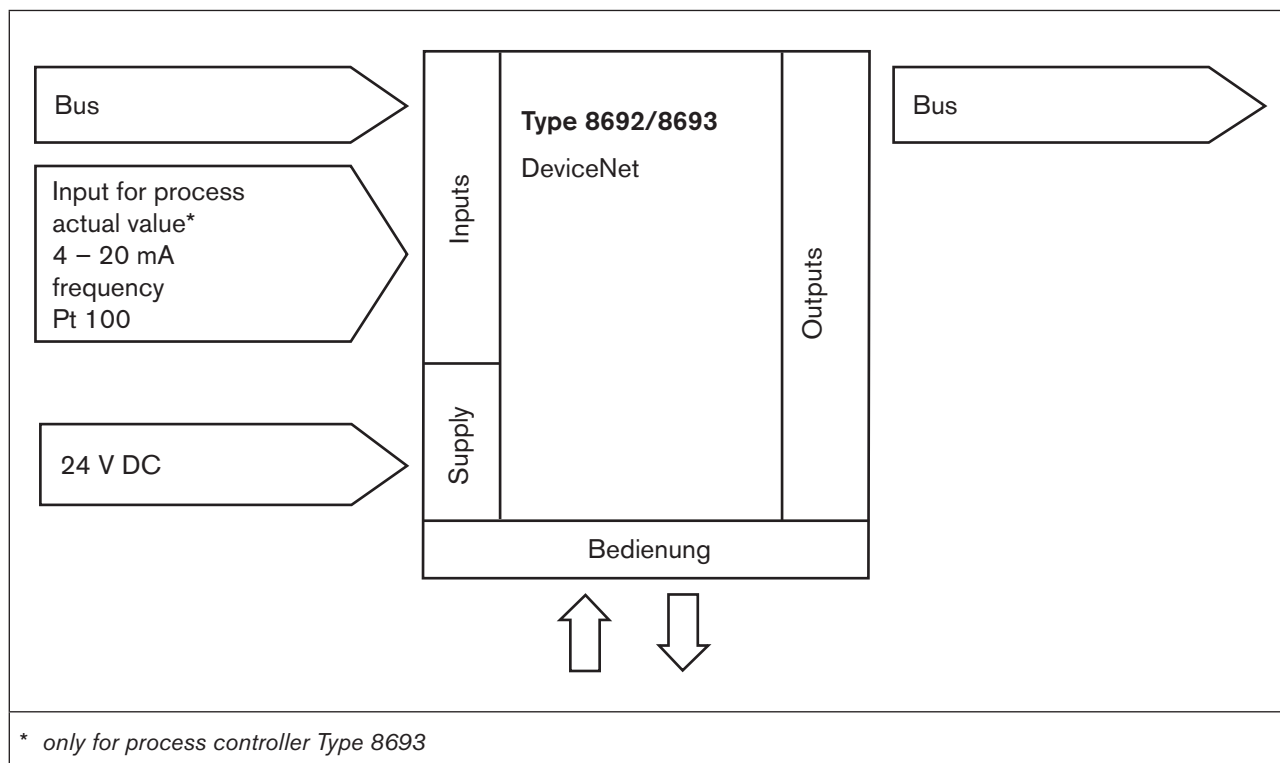


Figure 131: DeviceNet interfaces

30.4 Safety settings if the bus fails

The position is approached which corresponds to the set-point value last transferred (default setting).

Other setting options (see chapter [“32.3 BUS.COMM – Settings on Type 8692/8693”](#)).

MAN 1000108626 EN Version: F Status: RL (released | freigegeben) printed: 20.01.2015

30.5 Bus status display

The bus status is indicated on the display on the device.

Display (is displayed approx. every 3 seconds)	Device status	Explanation	Troubleshooting
<i>BUS offline</i>	Offline	<p>Device is not connected to the bus.</p> <p>The network access procedure (Duplicate MAC-ID-Test, duration approx. 2 s) has still not ended.</p> <p>The device is the only active network node.</p>	<ul style="list-style-type: none"> ▪ Check whether the baud rate has been correctly set network-wide. ▪ Bus connection including plug assignment correct. ▪ Check operating supply and bus connection of the other nodes.
<i>BUS no connection</i>	Online, no connection to the master	<p>Device is connected correctly to the bus, the network access procedure has ended without errors, however there is no established connection to the master.</p>	<ul style="list-style-type: none"> ▪ New connection established by master.
<i>BUS timeout</i>	I/O connection timeout	<p>An I/O connection is in the TIME OUT state.</p>	<ul style="list-style-type: none"> ▪ New connection established by master. ▪ Ensure that I/O data is transferred cyclically or, if COS confirmed, that corresponding Acknowledge messages are sent by the master.
<i>BUS critical err</i>	Critical bus error	<p>Other device with the same address in the network.</p> <p>BUS offline due to communication problems.</p>	<ul style="list-style-type: none"> ▪ Change address of the device and restart device ▪ Error analysis in the network with a bus monitor.

Table 108: Bus status display; DeviceNet

30.6 Differences between the field bus devices and devices without a field bus

The following chapters of these operating instructions are not valid for Type 8692/8693 with DeviceNet.

- Section "Installation" Chapter "[13 Electrical Installation 24 V DC](#)"
- Section "Start-up" Chapter "[22.2 INPUT - Setting the input signal](#)"
- Section "Auxiliary functions" Chapter "[25.2.5 SPLTRNG – Signal split range](#)"

Chapter "[25.2.15 CAL.USER – Calibration of actual value and set-point value](#)"
 - Menu option *calibr.INP*, calibration of the position set-point value
 - Menu option *calibr.SP*, calibration of the process set-point value
Chapter "[25.2.13 BINARY.IN – Activation of the binary input](#)"

Chapter "[25.2.14 OUTPUT – Configuring the outputs \(option\)](#)"

31 ELECTRICAL CONNECTIONS



DANGER!

Risk of injury due to electrical shock!

- ▶ Before reaching into the device or the equipment, switch off the operating voltage and secure to prevent reactivation!
- ▶ Observe applicable accident prevention and safety regulations for electrical equipment!



WARNING!

Risk of injury from improper installation!

- ▶ Installation may be carried out by authorized technicians only and with the appropriate tools!

Risk of injury from unintentional activation of the system and an uncontrolled restart!

- ▶ Secure system from unintentional activation.
- ▶ Following installation, ensure a controlled restart.

For operation of the device the following must always be connected:

- **X6** - circular connector M12, 8-pole
(for operating voltage see ["Table 110: X6 - M12 circular connector, 4-pole \(operating voltage\)"](#))
and
- **X3** - circular connector M12, 5-pole,
(see ["Table 109: X3 - M12 circular connector, 5 pole \(bus connection\), DeviceNet"](#))

Procedure:

- Connect Type 8692/8693 according to the tables.

On the electrical connection housing is a setscrew with nut for connection of the technical earth.
(see ["Figure 132: Electrical connection DeviceNet, Type 8692/8693"](#)).

- Connect setscrew to a suitable grounding point. To ensure electromagnetic compatibility (EMC), ensure that the cable is as short as possible (max. 30 cm, Ø 1,5 mm²).

When the operating voltage is applied, Type 8692/8693 is operating.

- Now make the required basic settings and adjustments for the positioner/process controller.
See chapter ["32.2 Start-up sequence"](#).

NOTE!

Electromagnetic compatibility (EMC) is only ensured if the appliance is connected correctly to an earthing point.

On the outside of the housing is a TE terminal for connection of the technical earth (TE).

- Connect the TE terminal to the earthing point via a shortest possible cable (maximum length 30 cm).

31.1 Connection diagram DeviceNet, Type 8692/8693

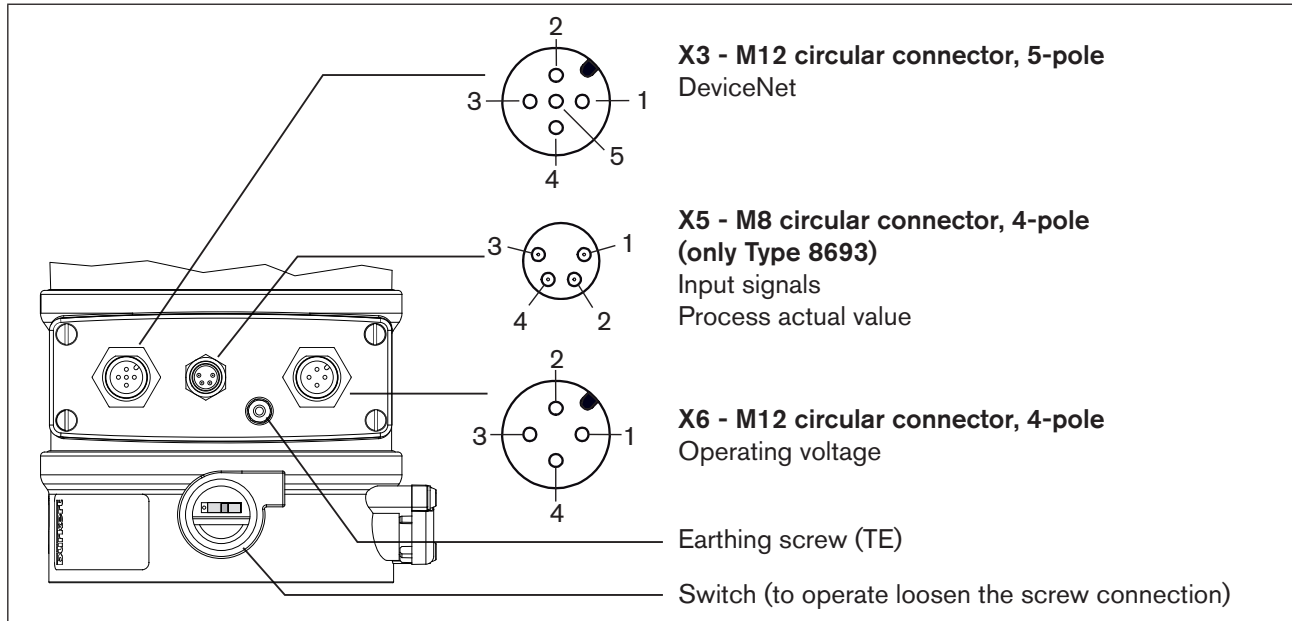


Figure 132: Electrical connection DeviceNet, Type 8692/8693



The device is supplied by the operating voltage, galvanically isolated from the DeviceNet, not by the V+ and V- voltage of the DeviceNet.

31.2 X3 - M12 circular connector, 5-pole (bus connection)

Pin	Signal	Color	Configuration
1	Shielding	not used	
2	V+	not used	
3	V-	not used	
4	CAN H	white	
5	CAN L	blue	

Table 109: X3 - M12 circular connector, 5 pole (bus connection), DeviceNet


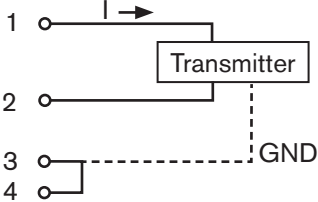




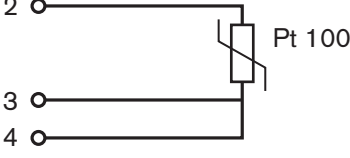
31.3 X6 - M12 circular connector, 4-pole (operating voltage)

Pin	Wire color*	Configuration	On the device side	External circuit / Signal level
1	brown	+24 V		24 V DC \pm 10 % max. residual ripple 10%
2		not used		
3	blue	GND		
4		not used		

* The indicated wire colours refer to the connection cable, part no. 918038, available as an accessory.

Table 110: X6 - M12 circular connector, 4-pole (operating voltage)

31.4 X5 - M8 circular connector, 4-pole - input signals process actual value (only Type 8693)

input type*	Pin	Wire color **	Assignment	Switch ***	On the device side	External circuit
4 ... 20 mA - internally supplied	1 2 3 4	brown white blue black	+24 V supply transmitter Output of transmitter GND (identical with GND operating voltage) Bridge to GND (GND from 3-wire transmitter)	 Switch on left		
4 ... 20 mA - externally supplied	1 2 3 4	brown white blue black	not assigned Process actual + not assigned Process actual -	 Switch on right	2 ○ — 4 ... 20 mA 4 ○ — GND 4 ... 20 mA	
Frequenz - internally supplied	1 2 3 4	brown white blue black	+24 V sensor supply Clock input + Clock input - (GND) not assigned	 Switch on left	1 ○ — +24 V 2 ○ — Clock + 3 ○ — Clock - / GND (identical with GND operating voltage)	
Frequenz - externally supplied	1 2 3 4	brown white blue black	not assigned Clock input + Clock input - not assigned	 Switch on right	2 ○ — Clock + 3 ○ — Clock -	
Pt 100 (see note below) ****	1 2 3 4	brown white blue black	not assigned Process actual 1 (current feed) Process actual 3 (GND) Process actual 2 (compensation)	 Switch on right		

* Can be adjusted via software (see chapter "24.2.1 PV-INPUT – Specifying signal type for the process actual value").
 ** The indicated colors refer to the connection cable available as an accessory (92903474).
 *** The switch is situated under the screw joint (see "Figure 132: Electrical connection DeviceNet, Type 8692/8693").

Table 111: X5 - M8 circular connector, 4-pole - input signals process actual value (only Type 8693)



**** For reasons of wire resistance compensation, connect the Pt 100 sensor via 3 wires. Always bridge Pin 3 and Pin 4 on the sensor.

When the operating voltage is applied, the Type 8692/8693 is operating.

→ Now make the required basic settings and actuate the automatic adjustment of the positioner/process controller. The procedure is described in chapter "20 Start-up sequence".

31.5 Terminating circuit for DeviceNet systems

When installing a DeviceNet system, ensure that the terminating circuit of the data lines is correct. The circuit prevents the occurrence of interference caused by signals reflected onto the data lines. The trunk line must be terminated at both ends with resistors of 120 Ω each and 1/4 W power loss (see “Figure 133: Network topology, DeviceNet”).

31.6 Network topology of a DeviceNet system

Line with one trunk line and several drop lines.

Trunk and drop lines are made of identical material (see “Figure 133: Network topology, DeviceNet”).

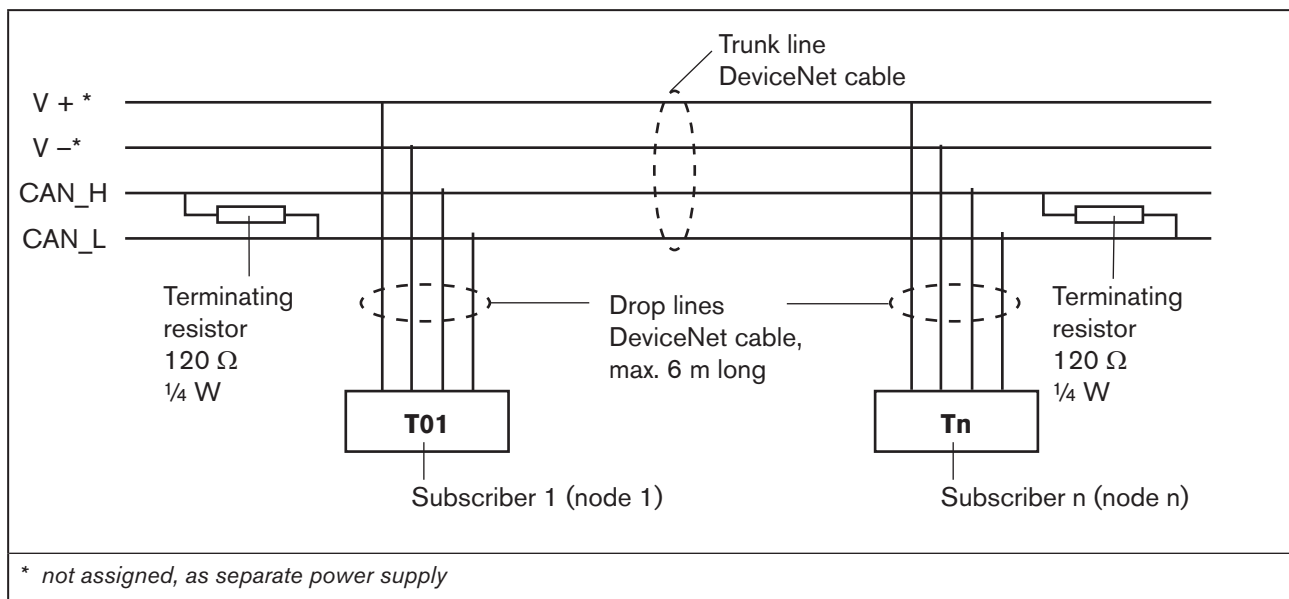


Figure 133: Network topology, DeviceNet

MAN 1000108626 EN Version: F Status: RL (released | freigegeben) printed: 20.01.2015

32 START-UP DEVICENET

32.1 Safety instructions



WARNING!

Risk of injury from improper operation!

Improper operation may result in injuries as well as damage to the device and the area around it

- ▶ Before start-up, ensure that the operating personnel are familiar with and completely understand the contents of the operating instructions.
- ▶ Observe the safety instructions and intended use.
- ▶ Only adequately trained personnel may start up the equipment/the device.



Before start-up, carry out pneumatic, fluid and electrical installation of Type 8692/8693 and of the valve. For a description see chapters [“12”](#) and [“31”](#).

32.2 Start-up sequence

The following basic settings are required for start-up of the DeviceNet version of Type 8692/8693:

Device type	Sequence	Type of basic setting	Setting via	Description in chapter
8692 and 8693	1	Generally not required for the initial start-up! The operating mode of the actuator has been preset in the factory.	<i>ACTUATOR</i>	“22.1”
8692 and 8693	2	Adjust device to the local conditions	<i>X.TUNE</i>	“22.3”
For 8693 only (Process control)	3	Activate process controller.	<i>ADD.FUNCTION</i>	“23”
8692 und 8693	4	Settings on Type 8692/8693: Input device address.	<i>BUS.COMM</i>	“32.3”
	5	Select baud rate.		
	6	Activate or deactivate safety position.		
	7	Configuration: The process data is transferred via an I/O connection. Initialize the I/O connection to transfer the <ul style="list-style-type: none"> – Static Input Assemblies – Static Output Assemblies. 	DeviceNet Master by means of EDS file and special software	“32.4”

32.3 BUS.COMM – Settings on Type 8692/8693

Set the following menu options in the *BUS.COMM* menu for start-up of the DeviceNet version:

Address 0 Enter a device address (value between 0 and 63)

BAUD RATE Selection of the baud rate

- The baud rate can be changed either by pressing the operator keys on the device or via the bus.
- A change has no effect until a reset (send a reset message to the identity object) or power up is implemented. This means if the changed baud rate attribute is accessed before a reset or power up, the read (changed) value does not agree with the still current baud rate (to be changed) of the network.

Select 125 kbit/s, 250 kbit/s or 500 kbit/s

BUS FAIL Activate or deactivate approach of the safety position





Selection **SafePos off** – The actuator remains in the position which corresponds to the set-point value last transferred (default setting).

Selection **SafePos on** – If there is a fault in the bus communication, the behavior of the actuator depends on the activation of the *SAFEPOS* auxiliary function.
See chapter "[25.2.11 SAFEPOS – Input the safety position](#)".

SAFEPOS activated: The actuator moves to the safety position which is specified in the *SAFEPOS* auxiliary function.

SAFEPOS deactivated: The actuator moves to the safety end position which it would assume if the electrical and pneumatic auxiliary power failed. See chapter "[10.9 Safety end positions after failure of the electrical or pneumatic auxiliary power](#)".

Procedure:

Key	Action	Description
MENU	Press  for approx. 3 s	Switching from process level ⇒ setting level.
▲ / ▼	Select <i>BUS.COMM</i>	Selection in the main menu (MAIN).
ENTER	Press 	The submenu options for basic settings can now be selected.
Setting device address		
▲ / ▼	Select <i>Address</i>	
INPUT	Press 	The input screen is opened.
▲ / ▼	+ Increase value - Reduce value	Enter a device address (value between 0 and 63).
OK	Press 	Return to <i>BUS.COMM</i> .

Key	Action	Description
Select baud rate		
▲ / ▼	Select <i>BAUD RATE</i>	
ENTER	Press	The input screen is opened.
▲ / ▼	Select baud rate	125 kBd / 250 kBd / 500 kBd
SELEC	Press	The selection is now marked by a filled circle ●.
EXIT	Press	Return to <i>BUS.COMM</i> .
Deactivating / activating safety position		
▲ / ▼	Select <i>BUS FAIL</i>	
ENTER	Press	The menu options for deactivating and activating the safety position are displayed.
▲ / ▼	Select menu option	<input type="checkbox"/> <i>SafePos off</i> = deactivated <input type="checkbox"/> <i>SafePos on</i> = activated
SELEC	Press	The selection is now marked by a filled circle ●.
EXIT	Press	Return to <i>BUS.COMM</i> .
EXIT	Press	Return to the main menu (MAIN).
EXIT	Press	Switching from setting level ⇒ process level.

Table 113: *BUS.COMM*; settings DeviceNet

MAN 1000108626 EN Version: F Status: RL (released | freigegeben) printed: 20.01.2015

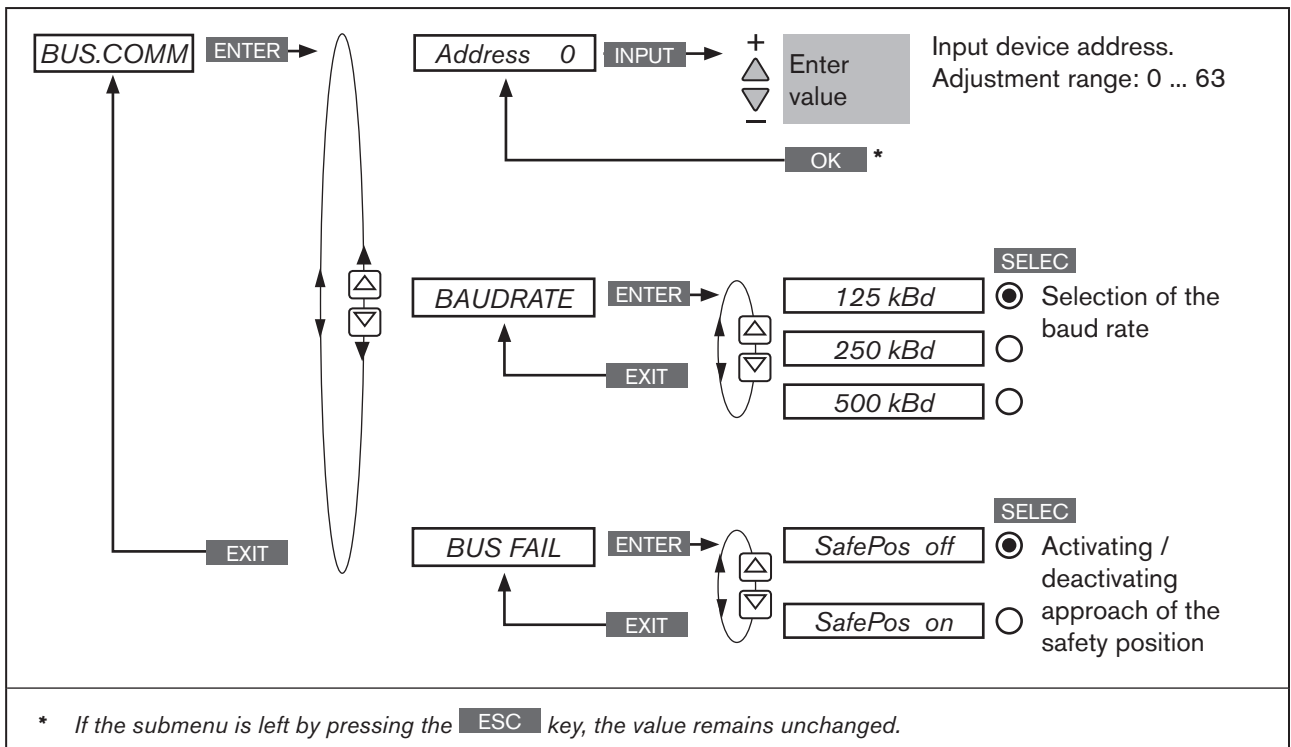


Figure 134: Operating structure - *BUS.COMM*; DeviceNet

32.4 Configuration of the process data

The following components are required for the configuration:

- Software suitable for the configuration. For example *RSNetWorx for DeviceNet* (Rev. 4.12.00).
- EDS file (is on the supplied CD)

Implementation of the configuration process is described in the following chapters "[32.5 Configuration example 1](#)" and "[32.6 Configuration example 2](#)".

Transmitting process data

To transmit process data via an I/O connection, 5 static input and 2 static output assemblies can be selected. These assemblies contain selected attributes combined into one object so that process data can be transmitted collectively via an I/O connection.

Selecting the process data

The process data is selected by setting the device parameters during initialization of an I/O connection according to the DeviceNet specification. The following device parameters can be set:

- Active Input Assembly and Active Output Assembly or
- Produced Connection Path and Consumed Connection Path
- if supported by the DeviceNet Master/Scanner -.

32.4.1 Static input assemblies

Name	Address of data attribute of the assemblies for read access. Class, Instance, Attribute	Format of the data attribute
<i>POS+ERR</i> (factory setting)	4, 1, 3	Byte 0: POS low Byte 1: POS high Byte 2: ERR
<i>POS+CMD+ERR</i>	4, 2, 3	Byte 0: POS low Byte 1: POS high Byte 2: CMD low Byte 3: CMD high Byte 4: ERR
<i>PV+ERR</i>	4, 3, 3	Byte 0: PV low Byte 1: PV high Byte 2: ERR
<i>PV+SP+ERR</i>	4, 4, 3	Byte 0: PV low Byte 1: PV high Byte 2: SP low Byte 3: SP high Byte 4: ERR
<i>PV+SP+CMD+ERR</i>	4, 5, 3	Byte 0: PV low Byte 1: PV high Byte 2: SP low Byte 3: SP high Byte 4: CMD low Byte 5: CMD high Byte 6: ERR

Table 114: Static input assemblies, DeviceNet

The addresses indicated in "Table 114" can be used as a path data for the attribute *Produced Connection Path* of an I/O connection.

The attributes described in more detail in the following "Table 115" can be transferred as input process data via this I/O connection.

Nevertheless, by using this address data, the attributes combined in the assemblies can also be accessed acyclically via *Explicit Messages*.

Name	Description of the input data attributes	Attribute Address Class, Instance, Attribute; Data type, Length
<i>POS</i>	Actual position Actual value of positioner as ‰. Value range 0 – 1000. However, values <0 or >1000 also possible if e.g. Autotune has not run through correctly.	111, 1, 59; INT, 2 byte
<i>CMD</i>	Set-point position Set-point value of positioner as ‰. Value range 0 – 1000.	111, 1, 58; UINT, 2 byte
<i>PV</i> *	Process actual value (process value) Actual value of process controller in physical unit (as set in the menu <i>P.CONTROL</i> → <i>SETUP</i> → <i>PV-INPUT</i> or <i>PV-SCALE</i>), max. value range -999 – 9999, depending on internal scaling.	120, 1, 3; INT, 2 byte
<i>SP</i> *	Process set-point value Set-point value of process controller in physical unit (as set in the menu <i>P.CONTROL</i> → <i>SETUP</i> → <i>SP-INPUT</i> or <i>SP-SCALE</i>), max. value range -999 – 9999, depending on internal scaling.	120, 1, 2; INT, 2 byte
<i>ERR</i>	Error Indicates the number of the process value (output) which was not written. The value is retained until it is deleted with "1" by acyclically writing the "Error" attribute (access via Explicit Message – Set Attribute Single). HEX 0X14 INP 0X15 SP	100, 1, 1; USINT, 1 byte
* relevant only for Type 8693 and when process controller activated.		

Table 115: Input data attributes; DeviceNet

32.4.2 Static output assemblies

Name	Address of data attribute of the assemblies for read access. Class, Instance, Attribute	Format of the data attribute
<i>INP</i> (factory setting)	4, 21, 3	Byte 0: INP low Byte 1: INP high
<i>SP</i>	4, 22, 3	Byte 0: SP low Byte 1: SP high

Table 116: *Static output assemblies; DeviceNet*

The addresses indicated in ["Table 116"](#) can be used as path data for the attribute *Consumed Connection Path* of an I/O connection.

The attributes described in more detail in the following ["Table 117"](#) can be transferred as output process data via this I/O connection.

Nevertheless, by using this address data, the attributes combined in the assemblies can also be accessed acyclically via *Explicit Messages*.

Name	Description of the output data attributes	Attribute Address Class, Instance, Attribute; Data type, Length
<i>INP</i>	<p>Set-point position</p> <p>Set-point value of positioner as ‰. Value range 0 – 1000.</p> <p>In "pure" position controller mode (<i>P.CONTROL</i> inactive) the transfer of the set-point position <i>INPUT</i> is required; as a process controller (<i>PCONTROL</i> active) the transfer of <i>INPUT</i> is not possible.</p> <p>If the value is too small or too large, the last valid value is used and is indicated in <i>ERR</i> with HEX 14.</p>	<p>111, 1, 58;</p> <p>UINT, 2 byte</p>
<i>SP</i> *	<p>Process set-point value</p> <p>Set-point value of process controller in physical unit (as set in the menu <i>P.CONTROL</i> → <i>SETUP</i> → <i>SP-INPUT</i> or <i>SP-SCALE</i>), max. value range -999 – 9999, depending on internal scaling.</p> <p>If the value is too small or too large, the last valid value is used and is indicated in <i>ERR</i> with HEX 15.</p>	<p>120, 1, 2;</p> <p>INT, 2 byte</p>
* relevant only for Type 8693 and when process controller activated.		

Table 117: *Output data attributes; DeviceNet*

32.5 Configuration example 1

The example describes the principle procedure when configuring the device using the software *RSNetWorx for DeviceNet* (Rev. 4.12.00).

32.5.1 Installation of the EDS file

The EDS file supplied on the CD is installed with the aid of the EDS Installation Wizard Tool associated with RSNetWorx.

During the installation procedure the icon also supplied on CD can be assigned (if this does not occur automatically).

32.5.2 Address assignment

There are two options of assigning an address to the devices.

- The address can be set by pressing the operator keys on the device to the required value within the range 0 – 63 (see chapter “32.3 BUS.COMM – Settings on Type 8692/8693”).
- with the aid of the Tools Node Commissioning belonging to RSNetWorx the address of connected devices can be changed via the bus. Therefore devices with the default address 63 can also be inserted sequentially into an existing network without difficulty.

The following image indicates how the new address 2 is assigned to a device with address 63.

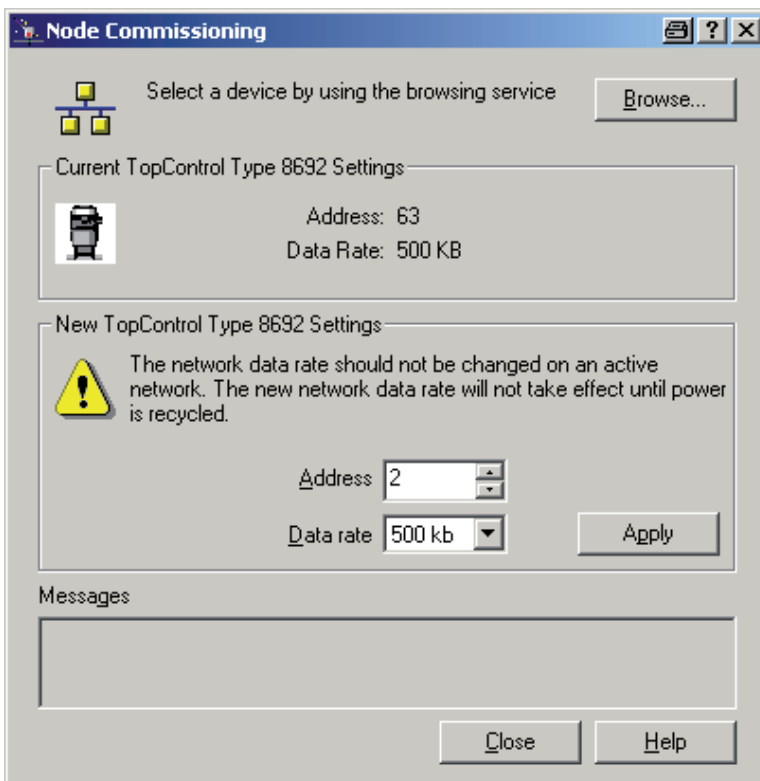


Figure 135: Screenshot - DeviceNet - Address assignment

32.5.3 Offline parameterization of the Device

When a device has been inserted into the DeviceNet configuration of *RSNetWorx*, the device can be parameterized offline.

“Figure 136” indicates how, for example, an input assembly which deviates from the factory setting (input process data can be transferred via I/O connection) can be selected.

However, ensure that the length of the process data during a subsequent configuration of the DeviceNet master/ scanner is adjusted accordingly (see chapter entitled “32.6 Configuration example 2”).



All parameter changes implemented offline must become operative for the real device at a later date by a download process.

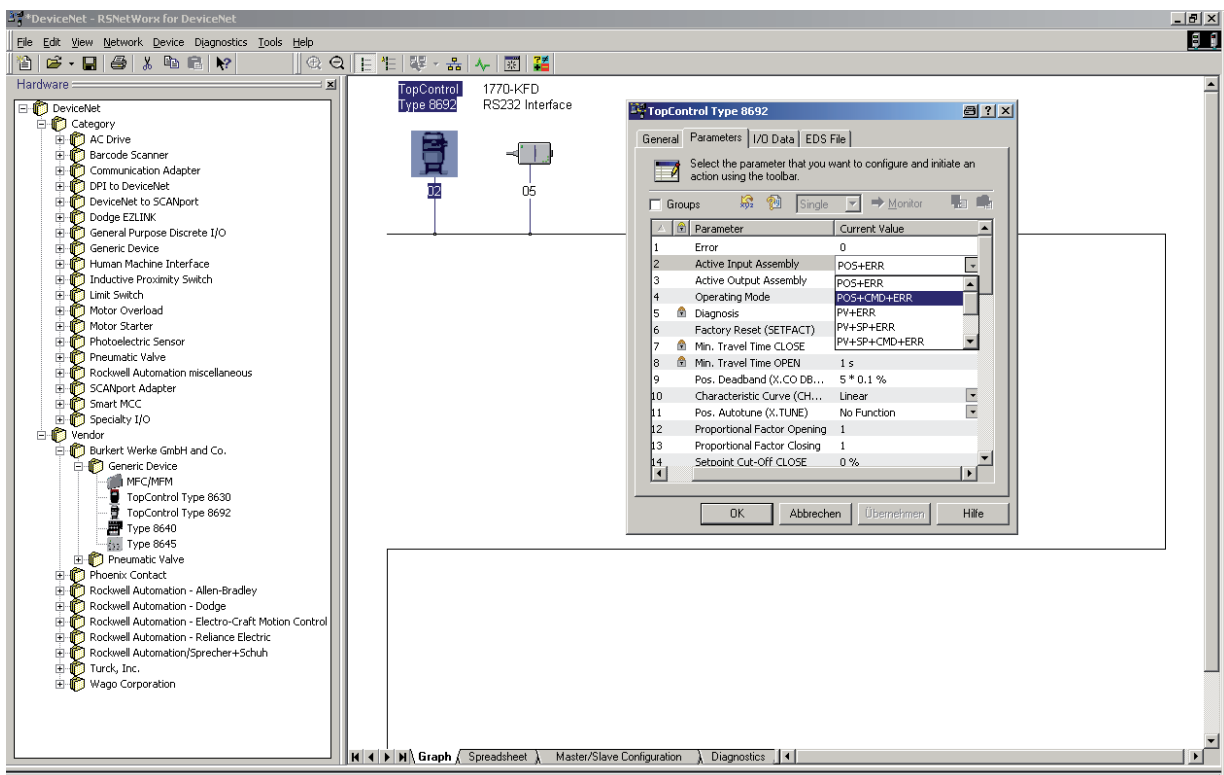


Figure 136: Screenshot - DeviceNet - Offline Parameterization, Select input assembly

32.5.4 Online parameterization of the Device

Devices can also be parameterized online. In doing so, you can also select whether only individual parameters (single) or all parameters (all) of a group are read from the device (upload) or are loaded into the device (download).

It is also possible to transfer individual parameters or all parameters of a group cyclically in monitor mode. This may be helpful particularly for start-up purposes.

“Figure 137” shows the group of the process values or diagnosis information.

- If *Monitor* is actuated, these values are updated cyclically.
- Explicit Messages are used for this cyclical access (no I/O connections).

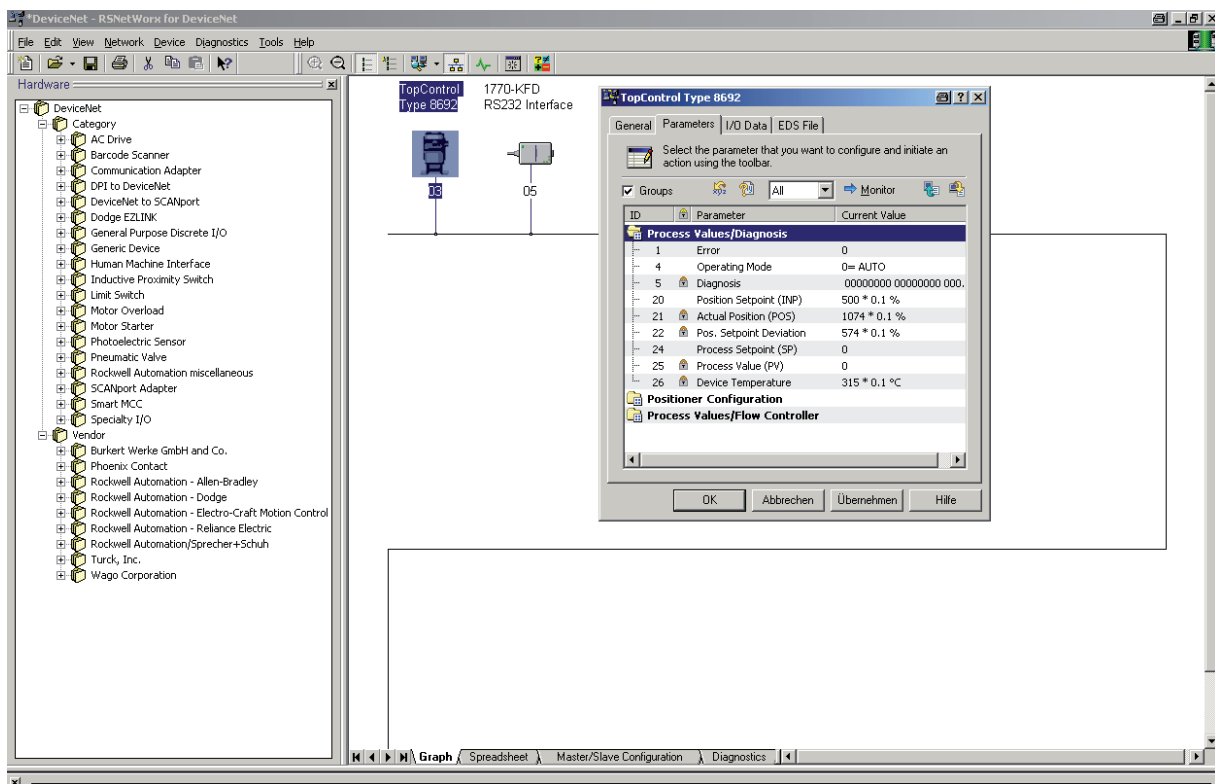


Figure 137: Screenshot - DeviceNet - Online Parameterization, process values/diagnosis information

32.6 Configuration example 2

This example describes the principle procedure for setting up the process image of a DeviceNet master/scanner using the software *RSNetWorx for DeviceNet* (Rev. 4.12.00).

Setting up the scan list and setting the I/O parameters

→ First of all set up the *scan list* of the DeviceNet master/scanner.

To do this, include the devices listed in the left part of the associated window in the scan list in the right part of the window.

→ Then the I/O parameters can be changed for each device included in the scan list.

This is required if assemblies which differ from the default settings were selected during configuration of the device in question.

“Figure 138” shows the setting of the I/O parameters when

- Input assembly

POS+CMD+ERR (5 bytes long) is selected and when

- Output assembly

INP (2 bytes long; default assembly - no change required) is selected

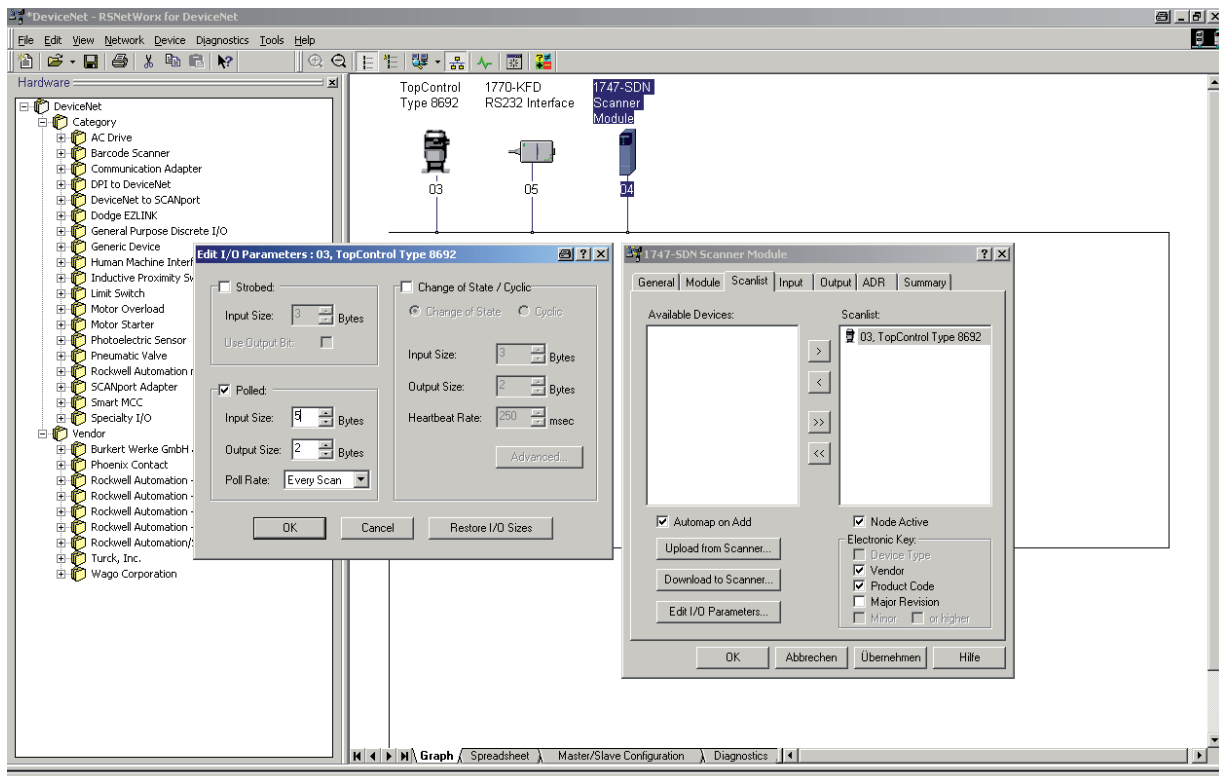


Figure 138: Screenshot - DeviceNet - Setting of I/O parameters

32.6.1 Setting up the process image (Mapping)

The *AUTOMAP* function is used to assign the input data of the devices specified in the scan list to the process image of the DeviceNet master/scanner.

In our example this is how the assignment indicated in “Figure 139” results.

For example the input process values of the device with address 3 are assigned to the internal addresses of the scanner as follows:

- Actual position I:1.1
- Set-point position I:1.2
- Error I:1.3

If the actual position of the device with address 3 is to be read from a control program, this is done by accessing I:1.1.

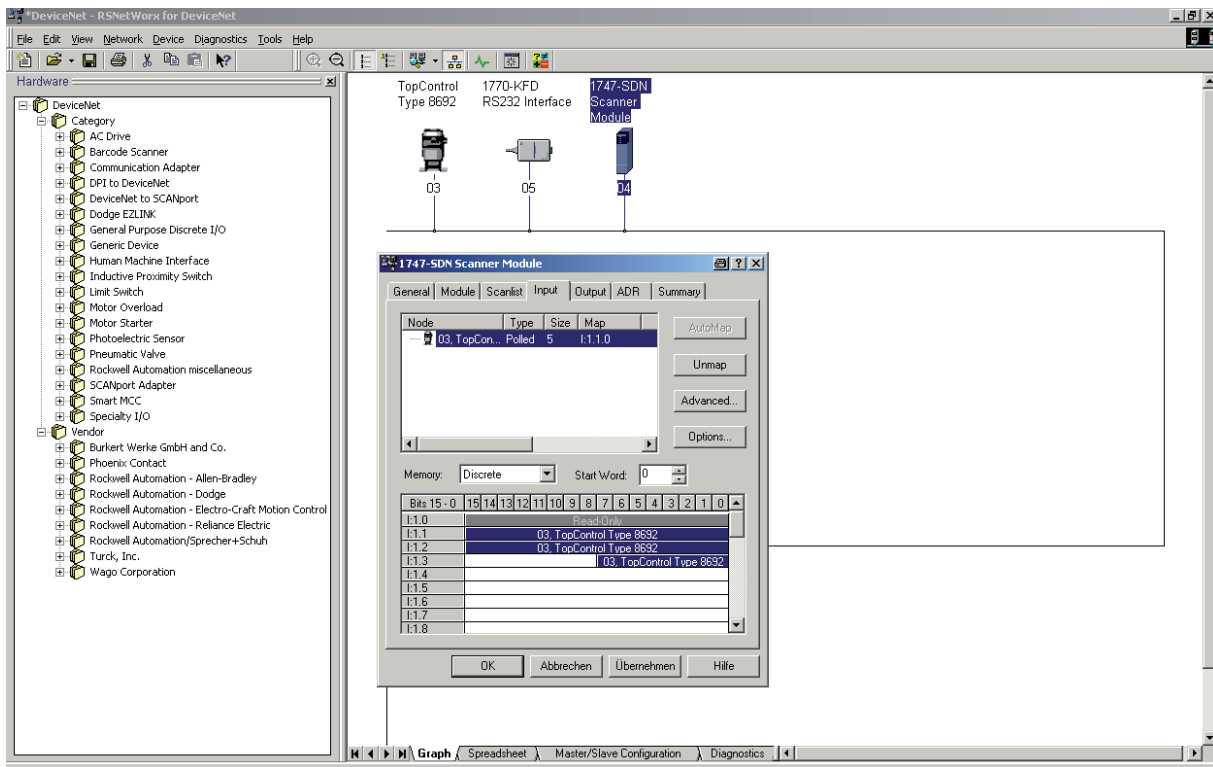


Figure 139: Screenshot - DeviceNet - Setting up process image

MAN 1000108626 EN Version: F Status: RL (released | freigegeben) printed: 20.01.2015

Maintenance and Troubleshooting

CONTENTS

33	MAINTENANCE.....	228
34	ERROR MESSAGES AND MALFUNCTIONS.....	228
34.1	Error messages on the display	228
34.1.1	General error messages	228
34.1.2	Error and warning messages while the X.TUNE function is running.....	229
34.1.3	Error messages while the P.Q'LIN function is running	230
34.1.4	Error messages while the P.TUNE function is running	230
34.1.5	Error Messages on Field Bus Devices	231
34.2	Other faults	232

33 MAINTENANCE

The Type 8692/8693 is maintenance-free when operated according to the instructions in this manual.

34 ERROR MESSAGES AND MALFUNCTIONS

34.1 Error messages on the display

34.1.1 General error messages



Display	Causes of error	Remedial action
	Minimum input value has been reached	Do not reduce value further
	Maximum input value has been reached	Do not increase value further
<i>CMD error</i>	Signal error Set-point value positioner (position controller)	Check signal
<i>SP error</i>	Signal error Set-point value process controller	Check signal
<i>PV error</i>	Signal error Actual value process controller	Check signal
<i>PT100 error</i>	Signal error Actual value Pt-100	Check signal
<i>invalid Code</i>	Incorrect access code	Input correct access code
<i>EEPROM fault</i>	EEPROM defective	Not possible, device defective

Table 118: General error message

34.1.2 Error and warning messages while the *X.TUNE* function is running

Display	Causes of error	Remedial action
<i>TUNE</i> <i>err/break</i>	Manual termination of self-parameterization by pressing the EXIT key	
<i>X.TUNE</i> <i>locked</i>	The <i>X.TUNE</i> function is blocked	Input access code
<i>X.TUNE</i> <i>ERROR 1</i>	No compressed air connected	Connect compressed air
<i>X.TUNE</i> <i>ERROR 2</i>	Compressed air failed during Autotune (<i>X.TUNE</i>).	Check compressed air supply
<i>X.TUNE</i> <i>ERROR 3</i>	Actuator or control system deaeration side leaking	Not possible, device defective
<i>X.TUNE</i> <i>ERROR 4</i>	Control system aeration side leaking	Not possible, device defective
<i>X.TUNE</i> <i>ERROR 6</i>	The end positions for <i>POS-MIN</i> and <i>POS-MAX</i> are too close together	Check compressed air supply
<i>X.TUNE</i> <i>ERROR 7</i>	Incorrect assignment <i>POS-MIN</i> and <i>POS-MAX</i>	To determine <i>POS-MIN</i> and <i>POS-MAX</i> , move the actuator in the direction indicated on the display.

Table 119: Error and warning message on *X.TUNE*

34.1.3 Error messages while the *P.Q'LIN* function is running

Display	Cause of fault	Remedial action
<i>Q.LIN</i> <i>err/break</i>	Manual termination of linearization by pressing the EXIT key.	
<i>P.Q'LIN</i> <i>ERROR 1</i>	No supply pressure connected.	Connect supply pressure.
	No change to process variable.	Check process and, if required, switch on pump or open the shut-off valve. Check process sensor.
<i>P.Q'LIN</i> <i>ERROR 2</i>	Current node of the valve stroke was not reached, as	
	▪ Supply pressure failed during <i>P.Q'LIN</i>	Check supply pressure.
	Autotune (<i>X.TUNE</i>) was not run.	Run Autotune (<i>X.TUNE</i>).

Table 120: Error message on *P.Q'LIN*; process controller Type 8693

34.1.4 Error messages while the *P.TUNE* function is running

Display	Cause of fault	Remedial action
<i>TUNE</i> <i>err/break</i>	Manual termination of self-optimization by pressing the EXIT key.	
<i>P.TUNE</i> <i>ERROR 1</i>	No supply pressure connected.	Connect supply pressure.
	No change to process variable.	Check process and, if required, switch on pump or open the shut-off valve. Check process sensor.

Table 121: Error message on *P.TUNE*; process controller Type 8693

34.1.5 Error Messages on Field Bus Devices

Display	Causes of error	Remedial action
<i>MFI fault</i>	Field bus board defective.	Not possible, device defective.

Table 122: Error Messages on Field Bus Devices

On DeviceNet:

Display (is displayed approx. every 3 seconds)	Device status	Explanation	Troubleshooting
<i>BUS offline</i>	Offline	Device is not connected to the bus. The network access procedure (Duplicate MAC-ID-Test, duration approx. 2 s) has still not ended. The device is the only active network node.	<ul style="list-style-type: none"> ▪ Check whether the baud rate has been correctly set network-wide. ▪ Bus connection including plug assignment correct. ▪ Check operating supply and bus connection of the other nodes.
<i>BUS no connection</i>	Online, no connection to the master	Device is connected correctly to the bus, the network access procedure has ended without errors, however there is no established connection to the master.	<ul style="list-style-type: none"> ▪ New connection established by master.
<i>BUS timeout</i>	I/O connection timeout	An I/O connection is in the TIME OUT state.	<ul style="list-style-type: none"> ▪ New connection established by master. ▪ Ensure that I/O data is transferred cyclically or, if COS confirmed, that corresponding Acknowledge messages are sent by the master.
<i>BUS critical err</i>	Critical bus error	Other device with the same address in the network. BUS offline due to communication problems.	<ul style="list-style-type: none"> ▪ Change address of the device and restart device ▪ Error analysis in the network with a bus monitor.

Table 123: Error message DeviceNet

On PROFIBUS DP:

Display	Device status	Explanation	Troubleshooting
<i>BUS offline</i> is displayed approx. every 3 seconds	Offline.	Device is not connected to the bus.	<ul style="list-style-type: none"> ▪ Check bus connection including plug assignment. ▪ Check operating voltage and bus connection of the other nodes.

Table 124: Error message PROFIBUS DP

34.2 Other faults

Problem	Possible causes	Remedial action
<p>$POS = 0$ (when $CMD > 0\%$) or $POS = 100\%$, (when $CMD < 100\%$)</p> <p>$PV = 0$ (when $SP > 0$) or $PV = PV$ (when $SP > SP$)</p>	Sealing function (<i>CUTOFF</i>) has been unintentionally activated	Deactivate sealing function.
<p>Applies only to devices with binary output:</p> <p>Binary output does not switch.</p>	<p>Binary output:</p> <ul style="list-style-type: none"> ▪ Current > 100 mA ▪ Short-circuit 	Check binary output connection.
<p>Applies only to devices with process controller:</p> <p>Device is not operating as a controller, despite correctly implemented settings.</p>	<i>P.CONTROL</i> menu option is in the main menu. The device is therefore operating as a process controller and expects a process actual value at the corresponding input.	Remove <i>P.CONTROL</i> menu option from the main menu. See chapter "25.1.2", page 109.

Table 125: Other faults

Packaging, Storage, Disposal

CONTENTS

35	PACKAGING AND TRANSPORT	234
36	STORAGE.....	234
37	DISPOSAL	234

35 PACKAGING AND TRANSPORT

NOTE!

Transport damages!

Inadequately protected equipment may be damaged during transport.

- During transportation protect the device against wet and dirt in shock-resistant packaging.
- Avoid exceeding or dropping below the allowable storage temperature.

36 STORAGE

NOTE!

Incorrect storage may damage the device.

- Store the device in a dry and dust-free location!
- Storage temperature. -20 – +65 °C.

37 DISPOSAL

→ Dispose of the device and packaging in an environmentally friendly manner.

NOTE!

Damage to the environment caused by device components contaminated with media.

- Observe applicable disposal regulations and environmental regulations.



Observe national waste disposal regulations.

Additional technical information

CONTENTS

38	SELECTION CRITERIA FOR CONTINUOUS VALVES	236
39	PROPERTIES OF PID CONTROLLERS.....	238
	39.1 P-portion.....	238
	39.2 I-portion.....	239
	39.3 D-portion.....	240
	39.4 Superposition of P, I and D Portions.....	241
	39.5 Implemented PID controller.....	242
	39.5.1 D Portion with delay.....	242
	39.5.2 Function of the real PID controller.....	242
40	ADJUSTMENT RULES FOR PID CONTROLLERS.....	243
	40.1 Adjustment rules according to Ziegler and Nichols (oscillation method)	243
	40.2 Adjustment rules according to Chien, Hrones and Reswick (actuating variable jump method).....	245

38 SELECTION CRITERIA FOR CONTINUOUS VALVES

The following criteria are crucial for optimum control behavior and to ensure that the required maximum flow is reached:

- the correct selection of the flow coefficient which is defined primarily by the orifice of the valve;
- close coordination between the nominal width of the valve and the pressure conditions in consideration of the remaining flow resistance in the equipment.

Design guidelines can be given on the basis of the flow coefficient (k_v value). The k_v value refers to standardised conditions with respect to pressure, temperature and media properties.

The k_v value describes the flow rate of water through a component in m^3/h at a pressure difference of $\Delta p = 1$ bar and $T = 20$ °C.

The " k_{vs} value" is also used for continuous valves. This indicates the k_v value when the continuous valve is fully open.

Depending on the specified data, it is necessary to differentiate between the two following cases when selecting the valve:

- a) The pressure values p_1 and p_2 , known before and after the valve, represent the required maximum flow-rate Q_{max} which is to be reached:

The required k_{vs} value is calculated as follows:

$$k_{vs} = Q_{max} \cdot \sqrt{\frac{\Delta p_0}{\Delta p}} \cdot \sqrt{\frac{\rho}{\rho_0}} \quad (1)$$

Meaning of the symbols:

k_{vs}	flow coefficient of the continuous valve when fully open [m^3/h]
Q_{max}	maximum volume flow rate [m^3/h]
Δp_0	= 1 bar; pressure loss on the valve according to the definition of the k_v value
ρ_0	= 1000 kg/m^3 ; density of water (according to the definition of the k_v value)
Δp	pressure loss on the valve [bar]
ρ	density of the medium [kg/m^3]

- b) The pressure values, known at the input and output of the entire equipment (p_1 and p_2), represent the required maximum flow-rate Q_{max} which is to be reached:

- 1st step: Calculate the flow coefficient of the entire equipment $k_{v_{ges}}$ according to equation (1).
- 2nd step: Determine the flow-rate through the equipment without the continuous valve (e.g. by "short-circuiting" the line at the installation location of the continuous valve).
- 3rd step: Calculate the flow coefficient of the equipment without the continuous valve (k_{va}) according to equation (1).
- 4th step: Calculate the required k_{vs} value of the continuous valve according to equation (2):

$$k_{vs} = \sqrt{\frac{1}{\frac{1}{k_{v_{ges}}^2} - \frac{1}{k_{va}^2}}} \quad (2)$$



The k_{VS} value of the continuous valve should have at least the value which is calculated according to equation (1) or (2) which is appropriate to the application, however it should never be far above the calculated value.

The rule of thumb "slightly higher is never harmful" often used for switching valves may greatly impair the control behavior of continuous valves!

The upper limit for the k_{VS} value of the continuous valve can be specified in practice via the so-called valve authority Ψ :

$$\Psi = \frac{(\Delta p)_{V0}}{(\Delta p)_0} = \frac{k_{Va}^2}{k_{Va}^2 + k_{Vs}^2} \quad (3)$$

$(\Delta p)_{V0}$ Pressure drop over the fully opened valve

$(\Delta p)_0$ Pressure drop over the entire equipment



If the valve authority $\Psi < 0.3$ the continuous valve has been oversized.

When the continuous valve is fully open, the flow resistance in this case is significantly less than the flow resistance of the remaining fluid components in the equipment. This means that the valve position predominates in the operating characteristic in the lower opening range only. For this reason the operating characteristic is highly deformed.

By selecting a progressive (equal percentage) transfer characteristic between position set-point value and valve stroke, this can be partially compensated and the operating characteristic linearised within certain limits. **However, the valve authority Ψ should be > 0.1 even if a correction characteristic is used.**

The control behavior (control quality, transient time) depends greatly on the working point if a correction characteristic is used.

39 PROPERTIES OF PID CONTROLLERS

A PID controller has a proportional, an integral and a differential portion (P, I and D portion).

39.1 P-portion

Function:

$$Y = K_p \cdot X_d$$

K_p is the proportional coefficient (proportional gain). It is the ratio of the adjusting range ΔY to the proportional range ΔX_d .

Characteristic and step response of the P portion of a PID controller

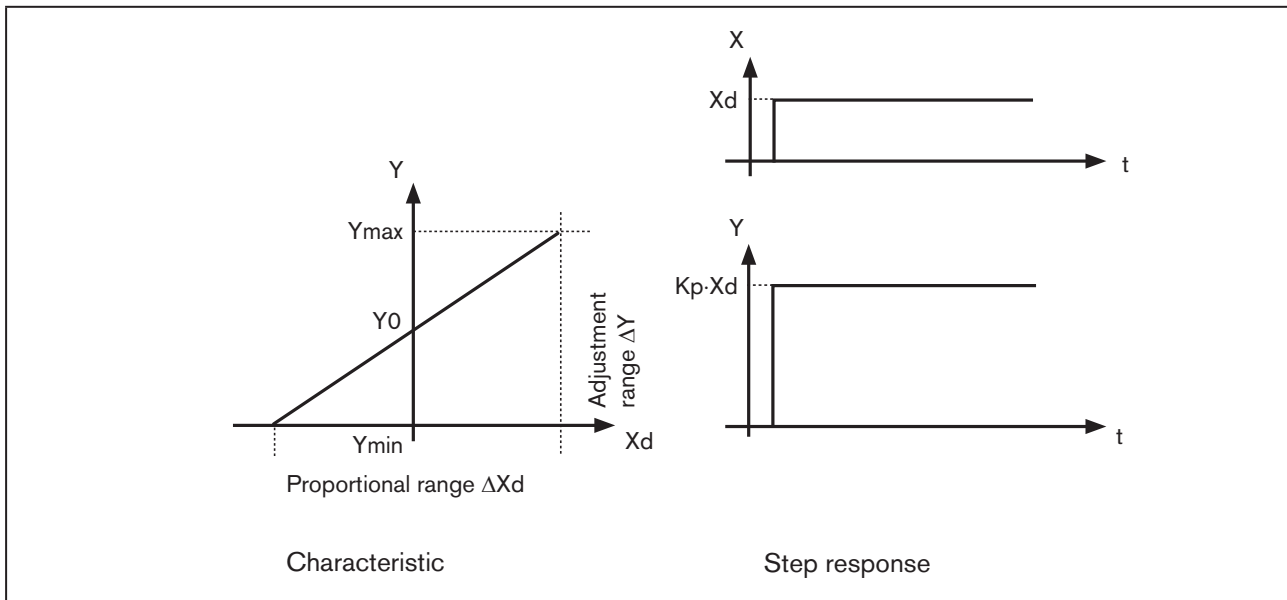


Figure 140: Characteristic and step response of the P portion of a PID controller

Properties

In theory a pure P-controller functions instantaneously, i.e. it is quick and therefore dynamically favorable. It has a constant control difference, i.e. it does not fully correct the effects of malfunctions and is therefore statically relatively unfavorable.

39.2 I-portion

Function:

$$Y = \frac{1}{T_i} \int X \, dt \quad (5)$$

T_i is the integral action time or actuating time. It is the time which passes until the actuating variable has run through the whole adjustment range.

Characteristic and step response of the I portion of a PID controller

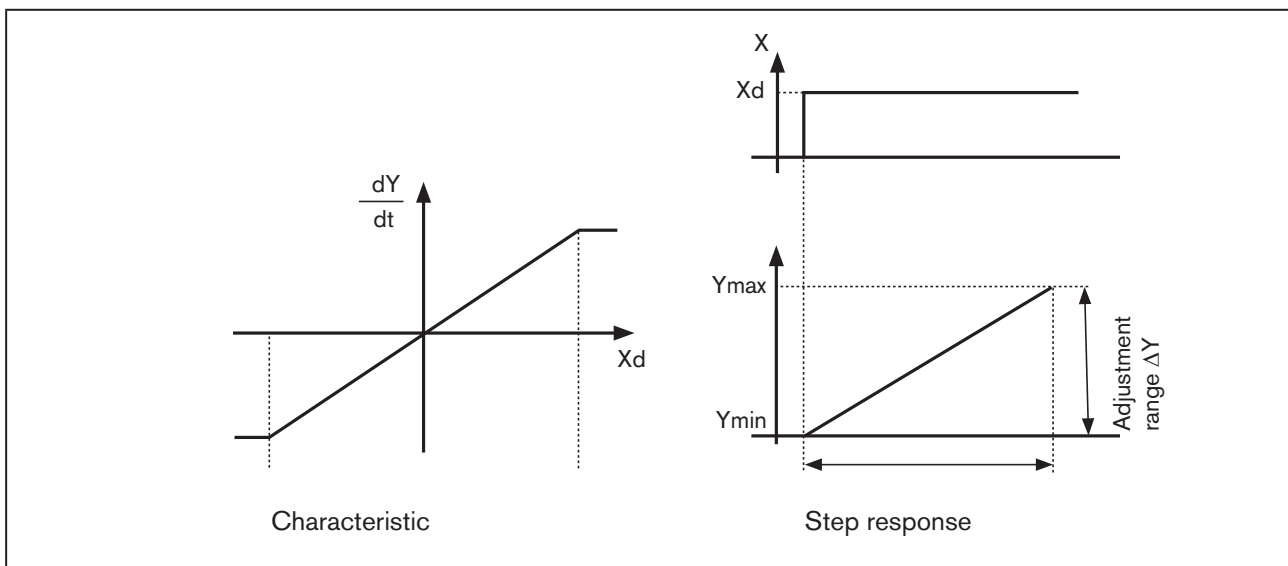


Figure 141: Characteristic and step response of the I portion of a PID controller

Properties

A pure I-controller completely eliminates the effects of any malfunctions which occur. It therefore has a favorable static behavior. On account of its final actuating speed control it operates slower than the P-controller and has a tendency to oscillate. It is therefore dynamically relatively unfavorable.

39.3 D-portion

Function:

$$Y = K_d \cdot \frac{dX}{dt} \quad (6)$$

K_d is the derivative action coefficient. The larger K_d is, the greater the D-effect is.

Characteristic and step response of the D portion of a PID controller

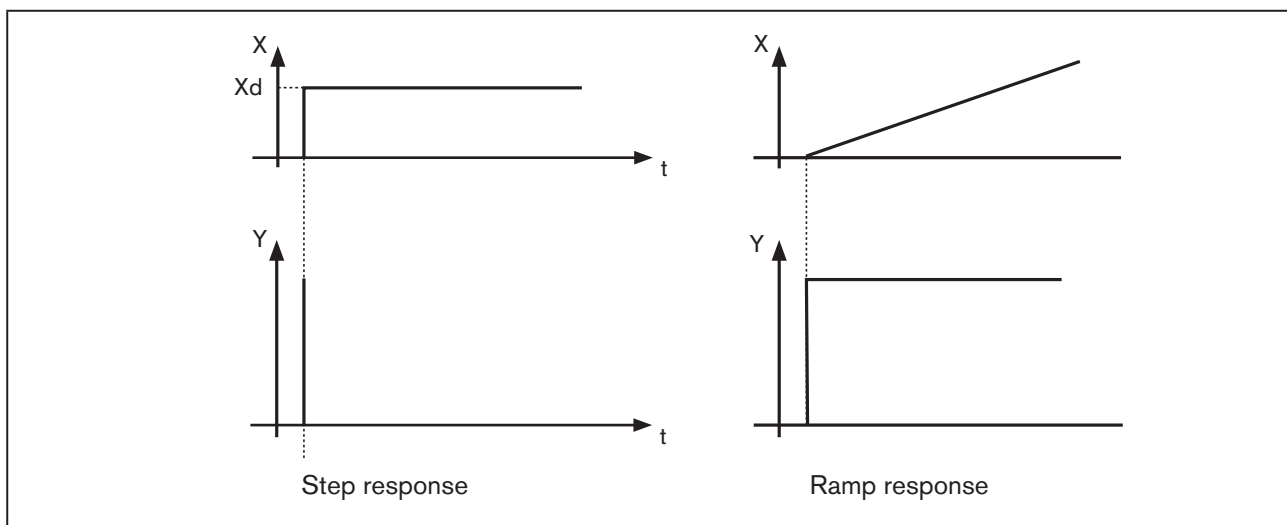


Figure 142: Characteristic and step response of the D portion of a PID controller

Properties

A controller with a D portion responds to changes in the control variable and may therefore reduce any control differences more quickly.

39.4 Superposition of P, I and D Portions

Function:

$$Y = K_p \cdot X_d + \frac{1}{T_i} \int X_d dt + K_d \frac{dX_d}{dt} \quad (7)$$

Where $K_p \cdot T_i = T_n$ and $K_d/K_p = T_v$ the **function of the PID controller** is calculated according to the following equation:

$$Y = K_p \cdot \left(X_d + \frac{1}{T_n} \int X_d dt + T_v \frac{dX_d}{dt} \right) \quad (8)$$

- K_p Proportional coefficient / proportional gain
- T_n Reset time
(Time which is required to obtain an equally large change in the actuating variable by the I portion, as occurs due to the P portion)
- T_v Derivative time
(Time by which a certain actuating variable is reached earlier on account of the D portion than with a pure P-controller)

Step response and ramp response of the PID controller

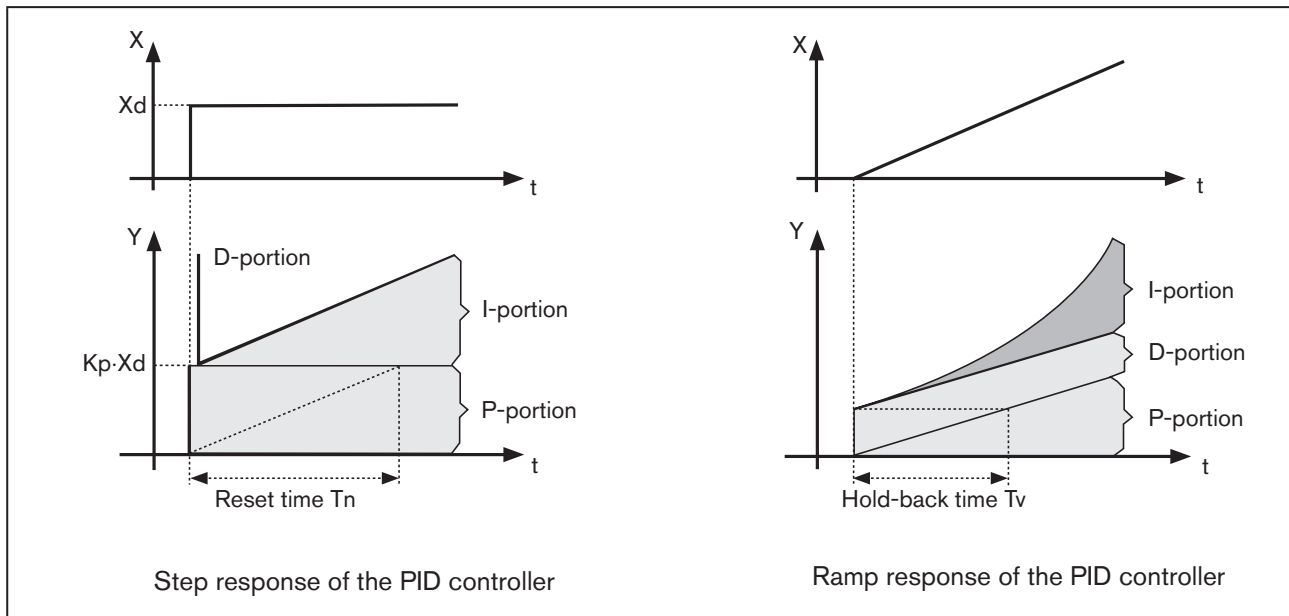


Figure 143: Characteristic of step response and ramp response of PID controller

MAN 1000108626 EN Version: F Status: RL (released | freigegeben) printed: 20.01.2015

39.5 Implemented PID controller

39.5.1 D Portion with delay

In the process controller Type 8693 the D portion is implemented with a delay T.

Function:

$$T \cdot \frac{dY}{dt} + Y = K_d \cdot \frac{dX_d}{dt} \quad (9)$$

Superposition of P, I and DT Portions

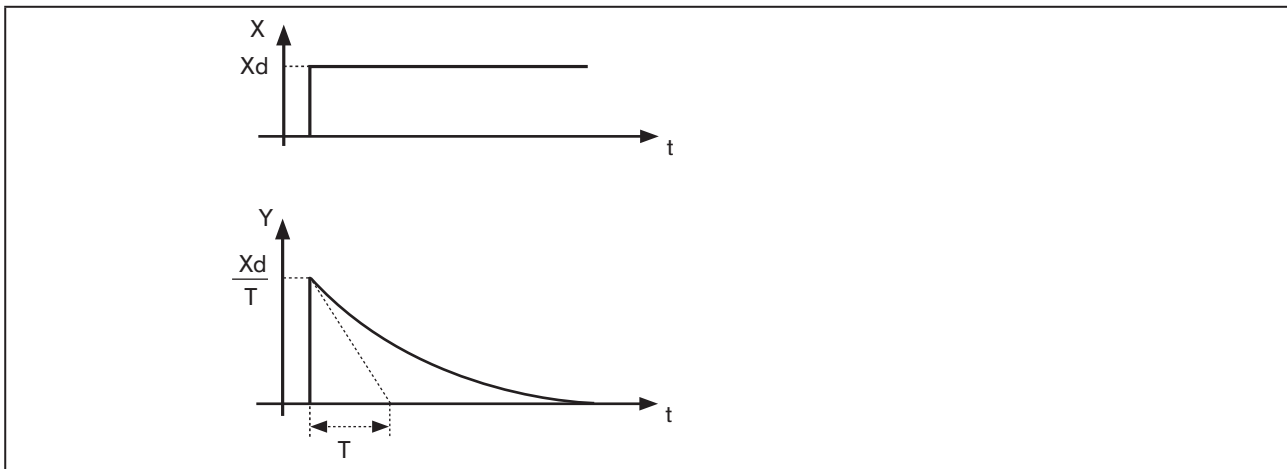


Figure 144: Characteristic of superposition of P, I and DT Portions

39.5.2 Function of the real PID controller

$$T \cdot \frac{dY}{dt} + Y = K_p \left(X_d + \frac{1}{T_n} \int X_d dt + T_v \frac{dX_d}{dt} \right) \quad (10)$$

Superposition of P, I and DT Portions

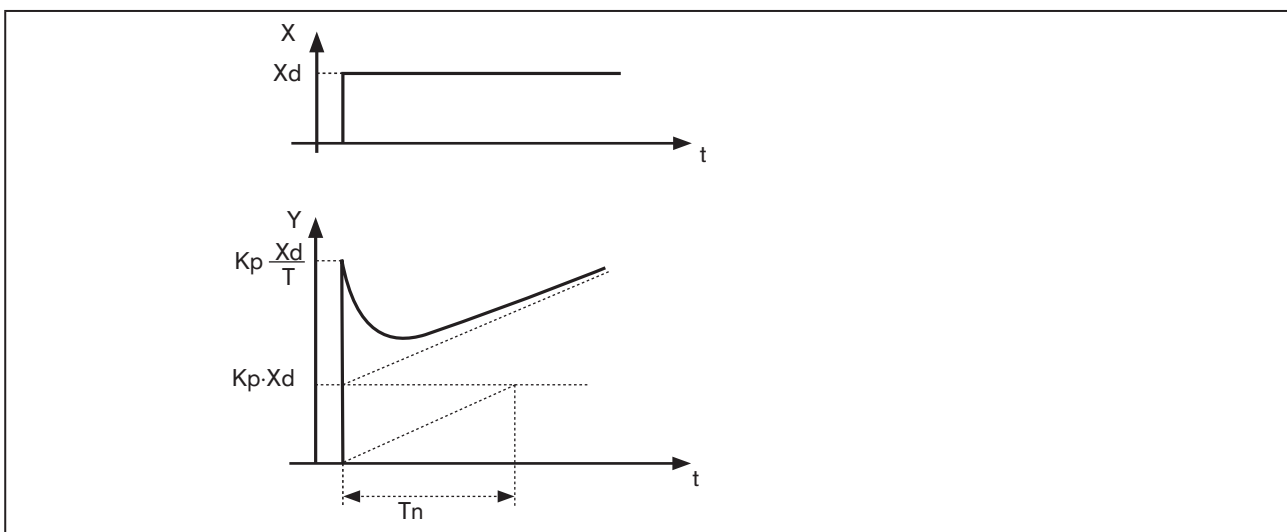


Figure 145: Characteristic of step response of the real PID controller

40 ADJUSTMENT RULES FOR PID CONTROLLERS

The control system Type 8693 features a self-optimization function for the structure and parameters of the integrated process controller. The determined PID parameters can be seen via the operating menu and re-optimized at will for an empirical path.

The regulatory literature includes a series of adjustment rules which can be used in experimental ways to determine a favorable setting for the controller parameters. To avoid incorrect settings, always observe the conditions under which the particular adjustment rules have been drawn up. Apart from the properties of the control process and the controller itself, the aspect whether a change in the disturbance variable or command variable is to be corrected plays a role.

40.1 Adjustment rules according to Ziegler and Nichols (oscillation method)

With this method the controller parameters are adjusted on the basis of the behavior of the control circuit at the stability limit. The controller parameters are first adjusted so that the control circuit starts to oscillate. The occurring critical characteristic values suggest a favorable adjustment of the controller parameters. A prerequisite for the application of this method of course is that the control circuit is oscillated.

Procedure

- Set controller as P-controller (i.e. $T_n = 999$, $T_v = 0$), first select a low value for K_p
- Set required set-point value
- Increase K_p until the control variable initiates an undamped continuous oscillation.

The proportionality coefficient (proportional gain) set at the stability limit is designated as K_{krit} . The resulting oscillation duration is designated as T_{krit} .

Progress of the control variable at the stability limit

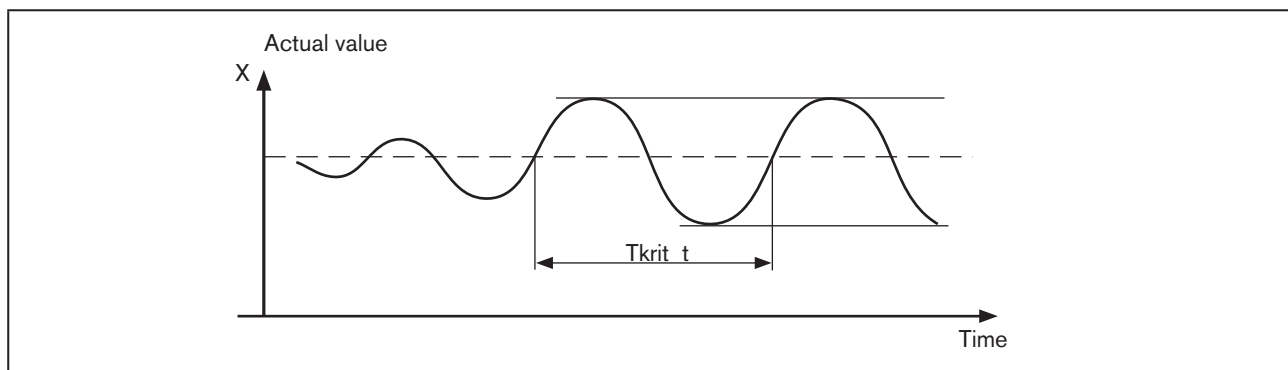


Figure 146: Progress of the control variable PID

The controller parameters can then be calculated from K_{krit} and T_{krit} according to the following table.

Adjustment of the parameters according to Ziegler and Nichols

Controller type	Adjustment of the parameters		
P controller	$K_p = 0.5 K_{krit}$	-	-
PI controller	$K_p = 0.45 K_{krit}$	$T_n = 0.85 T_{krit}$	-
PID controller	$K_p = 0.6 K_{krit}$	$T_n = 0.5 T_{krit}$	$T_v = 0.12 T_{krit}$

Table 126: Adjustment of the parameters according to Ziegler and Nichols

The adjustment rules of Ziegler and Nichols have been determined for P-controlled systems with a time delay of the first order and dead time. However, they apply only to controllers with a disturbance reaction and not to those with a reference reaction.

40.2 Adjustment rules according to Chien, Hrones and Reswick (actuating variable jump method)

With this method the controller parameters are adjusted on the basis of the transient behavior of the controlled system. An actuating variable jump of 100% is output. The times T_u and T_g are derived from the progress of the actual value of the control variable.

Progress of the control variable following an actuating variable jump ΔY

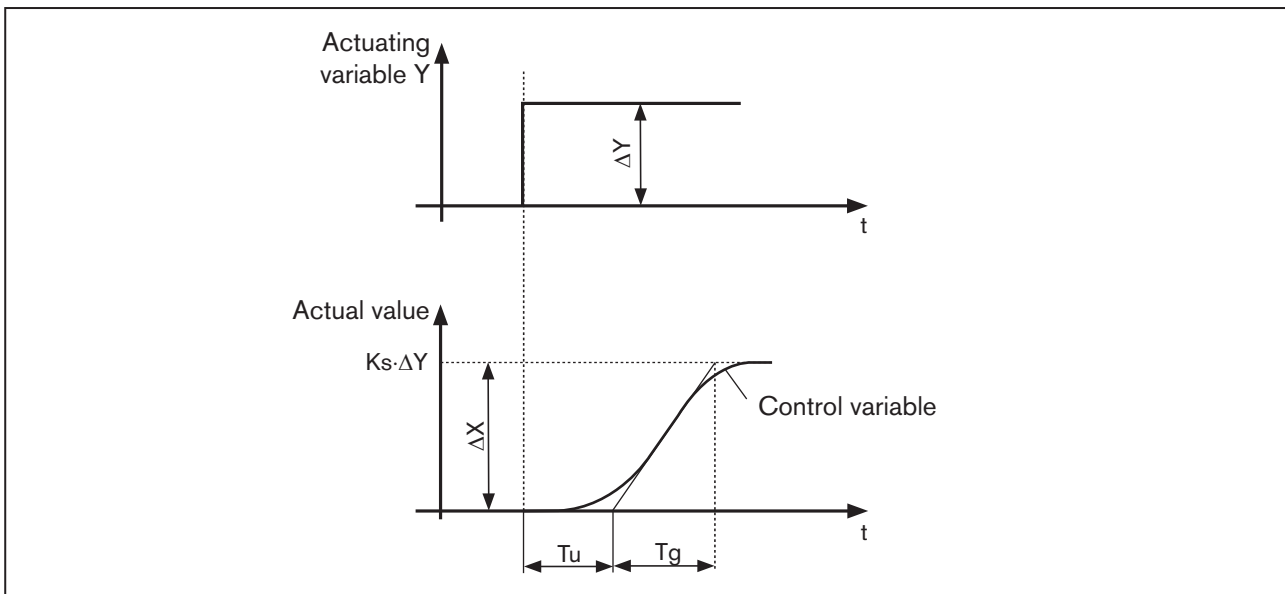


Figure 147: Progress of the control variable, actuating variable jump

Procedure

- Switch controller to MANUAL (MANU) operating state
- Output the actuating variable jump and record control variable with a recorder
- If progresses are critical (e.g. danger of overheating), switch off promptly.



Note that in thermally slow systems the actual value of the control variable may continue to rise after the controller has been switched off.

In the following "Table 127" the adjustment values have been specified for the controller parameters, depending on T_u , T_g and K_s for reference and disturbance reaction, as well as for an aperiodic control process and a control process with a 20% overshoot. They apply to controlled systems with P-behavior, with dead time and with a delay of the first order.

Adjustment of the parameters according to Chien, Hrones and Reswick

Controller type	Adjustment of the parameters			
	for aperiodic control process (0% overshoot)		for control process with 20% overshoot	
	Reference	Malfunction	Reference	Malfunction
P controller	$K_p = 0,3 \cdot \frac{T_g}{T_u \cdot K_s}$	$K_p = 0,3 \cdot \frac{T_g}{T_u \cdot K_s}$	$K_p = 0,7 \cdot \frac{T_g}{T_u \cdot K_s}$	$K_p = 0,7 \cdot \frac{T_g}{T_u \cdot K_s}$
PI controller	$K_p = 0,35 \cdot \frac{T_g}{T_u \cdot K_s}$ $T_n = 1,2 \cdot T_g$	$K_p = 0,6 \cdot \frac{T_g}{T_u \cdot K_s}$ $T_n = 4 \cdot T_u$	$K_p = 0,6 \cdot \frac{T_g}{T_u \cdot K_s}$ $T_n = T_g$	$K_p = 0,7 \cdot \frac{T_g}{T_u \cdot K_s}$ $T_n = 2,3 \cdot T_u$
PID controller	$K_p = 0,6 \cdot \frac{T_g}{T_u \cdot K_s}$ $T_n = T_g$ $T_v = 0,5 \cdot T_u$	$K_p = 0,95 \cdot \frac{T_g}{T_u \cdot K_s}$ $T_n = 2,4 \cdot T_u$ $T_v = 0,42 \cdot T_u$	$K_p = 0,95 \cdot \frac{T_g}{T_u \cdot K_s}$ $T_n = 1,35 \cdot T_g$ $T_v = 0,47 \cdot T_u$	$K_p = 1,2 \cdot \frac{T_g}{T_u \cdot K_s}$ $T_n = 2 \cdot T_u$ $T_v = 0,42 \cdot T_u$

Table 127: Adjustment of the parameters according to Chien, Hrones and Reswick

The proportionality factor K_s of the controlled system is calculated as follows:

$$K_s = \frac{\Delta X}{\Delta Y} \quad (11)$$

Tables for customer-specific settings

CONTENTS

41.	TABLE FOR YOUR SETTINGS ON THE POSITIONER	248
41.1.	Settings of the freely programmable characteristic	248
42.	TABLE FOR YOUR SETTINGS ON THE PROCESS CONTROLLER TYPE 8693	249
42.1.	Set parameters of the process controller	249

41. TABLE FOR YOUR SETTINGS ON THE POSITIONER

41.1. Settings of the freely programmable characteristic

Node (position set-point value as %)	Valve stroke [%]			
	Date:	Date:	Date:	Date:
0				
5				
10				
15				
20				
25				
30				
35				
40				
45				
50				
55				
60				
65				
70				
75				
80				
85				
90				
95				
100				

MAN 1000108626 EN Version: F Status: RL (released | freigegeben) printed: 20.01.2015

42. TABLE FOR YOUR SETTINGS ON THE PROCESS CONTROLLER TYPE 8693

42.1. Set parameters of the process controller

	Date:	Date:	Date:	Date:
KP				
TN				
TV				
X0				
DBND				
DP				
PVmin				
PVmax				
SPmin				
SPmax				
UNIT				
K factor				
FILTER				
INP				

MAN 1000108626 EN Version: F Status: RL (released | freigegeben) printed: 20.01.2015

