

INLINE fitting with paddle-wheel for flow measurement

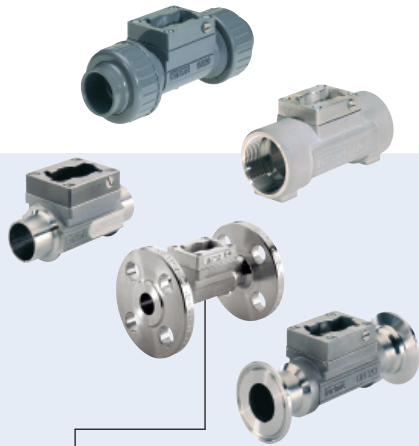

Type S030 can be combined with...



Type 8030
Flow sensor



Type 8032
On/Off flow sensor/switch



Type SE30 Ex
Flow sensor
ATEX version



Type 8035
Flow transmitter



Type 8036
Flow transmitter

- DN06 to DN65
- Closed pipe system, i.e. sensor inside fitting
- Quarter-turn technology
- Electronics available for
 - Indication, Monitoring, Transmitting
 - On/Off control, Batch control

The fitting S030 has a built-in paddle-wheel to measure the flowrate. When liquid flows through the pipe, the paddle-wheel is set in rotation producing pulses which frequency is proportional to the flowrate. This leads to a very leak-proof construction, called the "INLINE Quarter-turn" technology. The paddle-wheel rotation is detected contactless through the fitting wall. The sensor unit can be snapped-on or removed without opening the pipe or interrupting the process.

The Bürkert Quarter-turn technology



General data	
Pipe diameter	DN06 up to DN65
Measurement range	from 0.5 up to 1200 l/min
Flow velocity	0.3 up to 10 m/s (see flow diagram)
Accuracy¹⁾	Individual works calibration (Teach-In, via a remote transmitter) or standard mean K-factor - see accuracy chart on next page.
Linearity¹⁾	±0.5% of F.S.* (at 10 m/s)
Repeatability	±0.4% of Reading*
Fitting port connection	Internal or external thread, weld ends, Clamp or flange True union, spigot or external thread
Materials	Seal Body Screws Paddle-wheel Shaft and bearing
	FKM or EPDM (depending on version, see ordering chart) Stainless steel (316L -1.4435), brass (CuZn39Pb2), PVC, PP, PVDF Stainless steel (316L -1.4404) PVDF (PP on request or stainless steel, see data sheet 8030HT) Ceramics (Al2O3)
Medium data	
Fluid temperature	0 up to 50°C (32 to 122°F) for fitting in PVC 0 up to 80°C (32 to 176°F) for fitting in PP -15 up to 100°C (5 to 212°F) for fitting in stainless steel, brass or PVDF
Fluid pressure (max.)	see pressure / temperature chart Metal PN16 (232.16 PSI) (PN40 (580.4 PSI) on request) Plastic PN10 (145.1 PSI)
Fluid	clean, neutral or slightly aggressive, solid-free liquids max. 1%, size of particles 0.5 mm max.
Solid particles rate	300 cSt. max.
Viscosity	

* F.S. = Full scale (10 m/s)

1) Under reference conditions i.e. measuring fluid = water, ambient and water temperature = 20°C, applying the minimum inlet and outlet pipe straights, matched inside pipe dimensions.

Environment	
Ambient temperature (operating and storage)	-15 up to 50°C (5 to 122°F) for fitting in PVC -15 up to 80°C (5 to 176°F) for fitting in PP -15 up to 100°C (5 to 212°F) for fitting in stainless steel, brass or PVDF depending on associated electronics
Standards and approvals	
Standard - Pressure	Complying with article 3 of §3 from 97/23/CE directive.*
Approval / Certificate on request	3.1 Certificate; 2.2 Certificate; Rugosity Certificate; Calibration Certificate; FDA (with EPDM seal) - stainless steel fitting only

* For the 97/23/CE pressure directive, the device can only be used under following conditions (depend on max. pressure, pipe diameter and fluid).

Type of fluid	Conditions
Fluid group 1, §1.3.a	DN ≤ 25 only
Fluid group 2, §1.3.a	DN ≤ 32 or DN > 32 and PN*DN ≤ 1000
Fluid group 1, §1.3.b	PN*DN ≤ 2000
Fluid group 2, §1.3.b	DN ≤ 200

Pressure / temperature chart

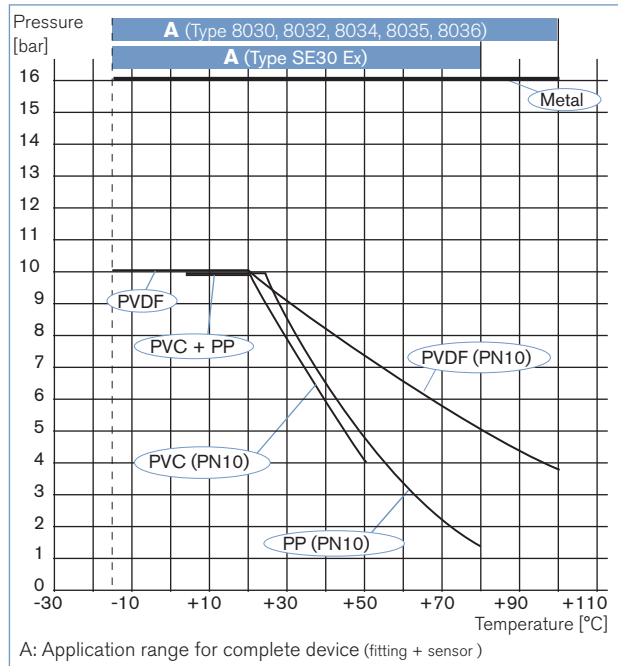

Accuracy diagram

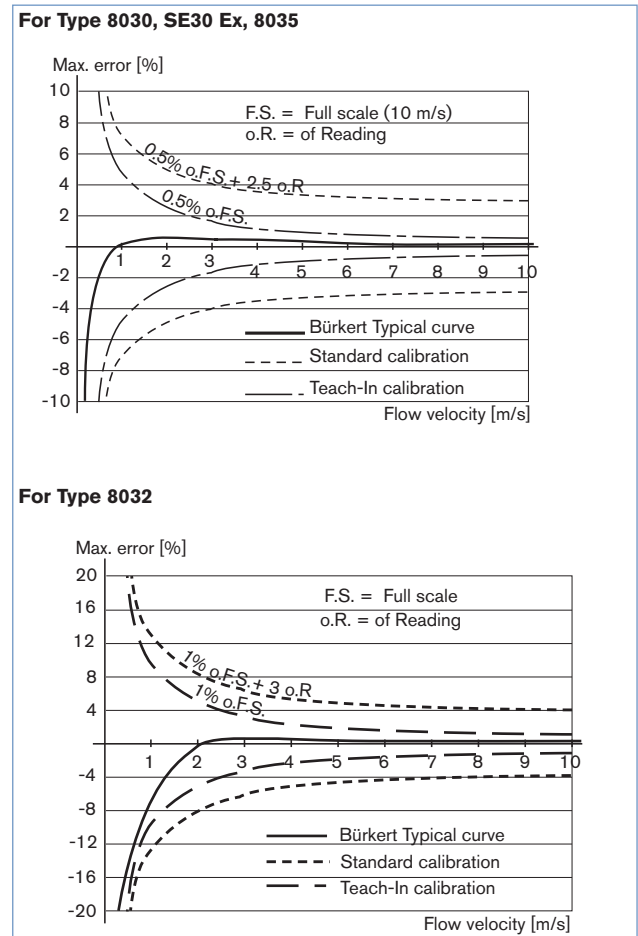

Installation

Minimum straight upstream and downstream distances must be observed. According to the pipe's design, necessary distances can be bigger or use a flow conditioner to obtain the best accuracy. For more information, please refer to EN ISO 5167-1.

EN ISO 5167-1 prescribes the straight inlet and outlet distances that must be complied with when installing fittings in pipe lines in order to achieve calm flow conditions. The most important layouts that could lead to turbulence in the flow are shown below, together with the associated prescribed minimum inlet and outlet distances. These ensure calm, problem-free measurement conditions at the measurement point.

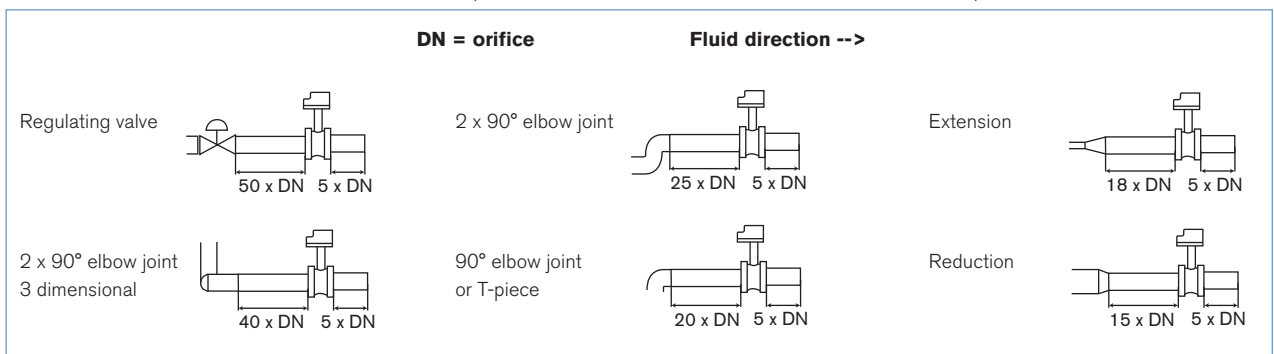

Installation

The flow rate sensor, transmitter can be installed into either horizontal or vertical pipes.

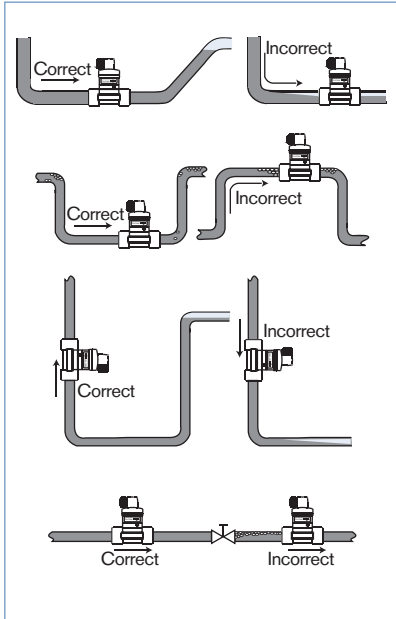

Pressure and temperature ratings must be respected according to the selected fitting material.

The suitable pipe size is selected using the diagram Flow / Velocity / DN.

Conception

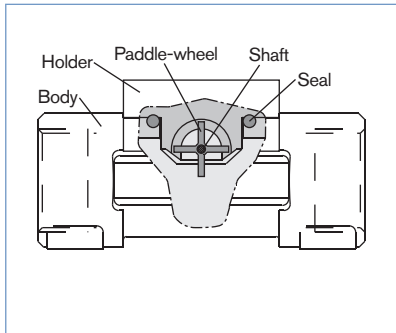

Selection fitting / pipe size

Example:

- Specification of nominal flow: 10 m³/h
- Ideal flow velocity: 2...3 m/s
- For these specifications, the diagram indicates a pipe size of DN40 [or DN50 for (*) mentioned fittings]

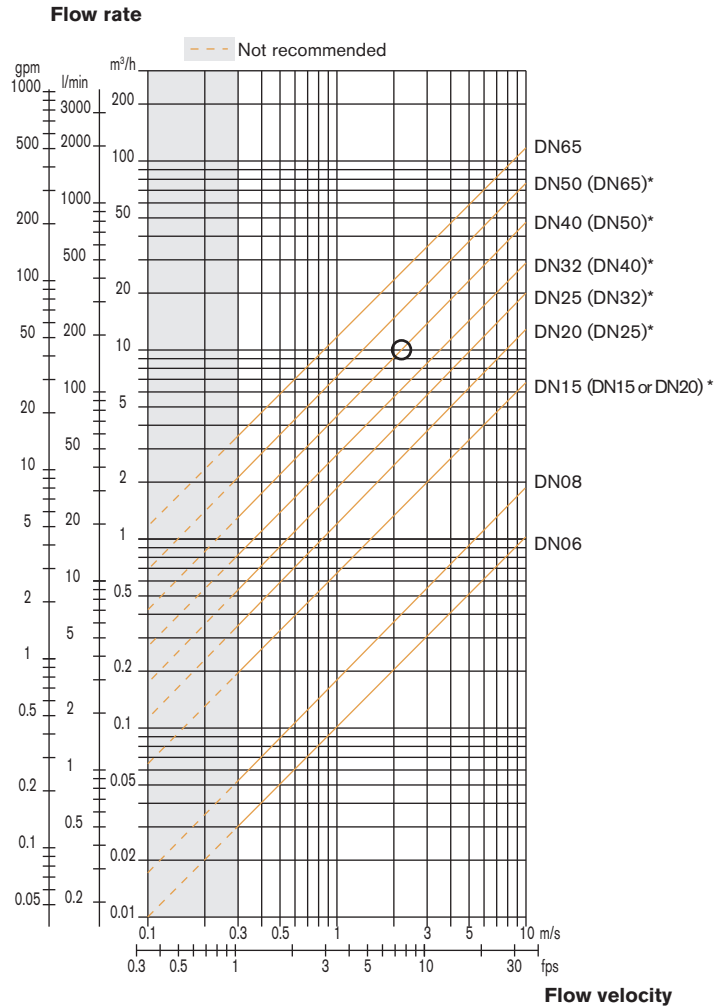

- * for following fittings:**
- with external threads acc. to SMS 1145
 - with weld-ends acc. to SMS 3008, BS 4825 / ASME BPE or DIN 11850 Series 2
 - Clamp acc. to SMS 3017 / ISO 2852, BS 4825 / ASME BPE or DIN 32676

INLINE fitting dimensions

Internal thread connection

G, NPT or Rc
 in stainless steel (316L - 1.4435) or
 brass (CuZn39Pb2)

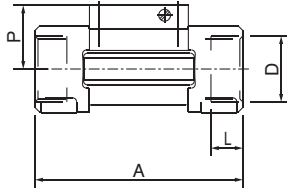

DN	P	A	D	L
[mm]	[mm]	[mm]	[inch]	[mm]
15	34.5	84.0	G 1/2	16.0
			NPT 1/2	17.0
			Rc 1/2	15.0
20	32.0	94.0	G 3/4	17.0
			NPT 3/4	18.3
			Rc 3/4	16.3
25	32.2	104.0	G 1	23.5
			NPT 1	18.0
			Rc 1	18.0
32	35.8	119.0	G 1 1/4	23.5
			NPT 1 1/4	21.0
			Rc 1 1/4	21.0
40	39.6	129.0	G 1 1/2	23.5
			NPT 1 1/2	20.0
			Rc 1 1/2	19.0
50	45.7	148.5	G 2	27.5
			NPT 2	24.0
			Rc 2	24.0

External thread connection

G, NPT or Rc
 in stainless steel (316L - 1.4435),
 brass (CuZn39Pb2),
 PVC (only DN 6 and DN 8)
 or PVDF (only DN 8)

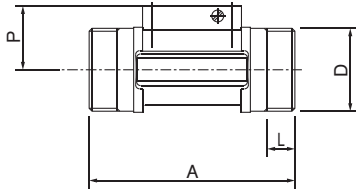

DN	P	A	D	L
[mm]	[mm]	[mm]	[inch]	[mm]
06	29.5	90.0	G1/4 or G1/2	-
08	29.5	90.0	1/2**	M 16 x 1.5
15	34.5	84.0	G 3/4	-
20	32.0	94.0	G 1	-
25	32.2	104.0	G 1 1/4	-
32	35.8	119.0	G 1 1/2	-
40	39.6	129.0	-	M 55 x 2
50	45.7	148.5	-	M 64 x 2

** G, NPT, RC according to fitting version

External thread connection

SMS 1145,
 in stainless steel (316L - 1.4435)

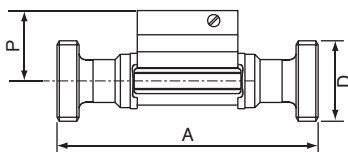

DN	P	A	D
[mm]	[mm]	[mm]	
25	32.0	130	Rd 40 x 1/6"
40	35.8	164	Rd 60 x 1/6"
50	39.6	173	Rd 70 x 1/6"

INLINE fitting dimensions

Weld ends connection

EN ISO 1127 / ISO 4200, SMS 3008,
BS 4825 / ASME BPE or DIN 11850 Series 2
in stainless steel (316L - 1.4435)

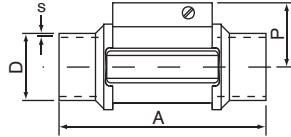

DN	P	A	Standard	D	s
[mm]	[mm]	[mm]		[mm]	[mm]
08	-	-	EN ISO 1127 / ISO 4200	-	-
	-	-	SMS 3008	-	-
	-	-	ASME BPE	-	-
	29.5	90.0	DIN 11850 Series 2	13.00	1.50
15	34.5	84.0	EN ISO 1127 / ISO 4200	21.30	1.60
	-	-	SMS 3008	-	-
	-	-	ASME BPE	-	-
20	34.5	84.0	DIN 11850 Series 2	19.0	1.50
	32.0	94.0	EN ISO 1127 / ISO 4200	26.9	1.60
	-	-	SMS 3008	-	-
25	34.5	84.0	ASME BPE	19.05	1.65
	34.5	84.0	DIN 11850 Series 2	23.00	1.50
	32.2	104.0	EN ISO 1127 / ISO 4200	33.70	2.00
32	32.0	94.0	SMS 3008	25.00	1.20
	32.0	94.0	BS 4825 / ASME BPE	25.40	1.65
	32.0	94.0	DIN 11850 Series 2	29.00	1.50
	35.8	119.0	EN ISO 1127 / ISO 4200	42.40	2.00
40	-	-	SMS 3008	-	-
	32.2	104.0	BS 4825 / ASME BPE	32.00	1.65
	32.2	104.0	DIN 11850 Series 2	35.00	1.50
	39.6	129.0	EN ISO 1127 / ISO 4200	48.30	2.00
50	35.8	119.0	SMS 3008	38.00	1.20
	35.8	119.0	BS 4825 / ASME BPE	38.10	1.65
	35.8	119.0	DIN 11850 Series 2	41.00	1.50
	45.7	148.5	EN ISO 1127 / ISO 4200	60.30	2.60
65	39.6	128.0	SMS 3008	51.00	1.20
	39.6	128.0	BS 4825 / ASME BPE	50.80	1.65
	39.6	128.0	DIN 11850 Series 2	53.00	1.50
	-	-	EN ISO 1127 / ISO 4200	-	-
-	45.7	147.0	SMS 3008	63.50	1.60
	45.7	147.0	BS 4825 / ASME BPE	63.50	1.65
	-	-	DIN 11850 Series 2	-	-
	-	-	-	-	-

INLINE fitting dimensions

Clamp connection

ISO (for pipe EN ISO 1127 / ISO 4200), SMS 3017 / ISO 2852*,
BS 4825 / ASME BPE* or DIN 32676
in stainless steel (316L - 1.4435)

* Available with internal surface finish Ra = 0.8 mm

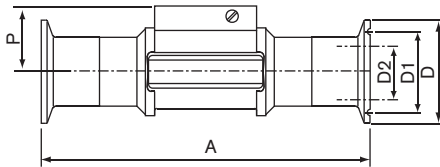

DN	P	A	Standard	D2	D1	D
[mm]	[mm]	[mm]		[mm]	[mm]	[mm]
08	-	-	ISO (for pipe EN ISO 1127 / ISO 4200)	-	-	-
	-	-	SMS 3017 / ISO 2852	-	-	-
	-	-	ASME BPE	-	-	-
	29.5	125	DIN 32676	10.00	27.5	34.0
15	34.5	130	ISO (for pipe EN ISO 1127 / ISO 4200)	18.10	27.5	34.0
	-	-	SMS 3017 / ISO 2852	-	-	-
	-	-	ASME BPE	-	-	-
	29.5	119	DIN 32676	16.00	27.5	34.0
20	32.0	150	ISO (for pipe EN ISO 1127 / ISO 4200)	23.70	43.5	50.5
	-	-	SMS 3017 / ISO 2852	-	-	-
	34.5	119	ASME BPE	15.75	19.6	25.0
	34.5	119	DIN 32676	20.00	27.5	34.0
25	32.2	160	ISO (for pipe EN ISO 1127 / ISO 4200)	29.70	43.5	50.5
	32.0	129	SMS 3017 / ISO 2852	22.60	43.5	50.5
	32.0	129	BS 4825 / ASME BPE	22.10	43.5	50.5
	32.0	136	DIN 32676	26.00	43.5	50.5
32	35.8	180	ISO (for pipe EN ISO 1127 / ISO 4200)	38.40	43.5	50.5
	-	-	SMS 3017 / ISO 2852	-	-	-
	-	-	BS 4825 / ASME BPE	-	-	-
	-	-	DIN 32676	-	-	-
40	39.6	200	ISO (for pipe EN ISO 1127 / ISO 4200)	44.30	56.5	64.0
	35.8	161	SMS 3017 / ISO 2852	35.60	43.5	50.5
	35.8	161	BS 4825 / ASME BPE	34.80	43.5	50.5
	35.8	161	DIN 32676	38.00	43.5	50.5
50	45.7	230	ISO (for pipe EN ISO 1127 / ISO 4200)	55.10	70.5	77.5
	39.6	192	SMS 3017 / ISO 2852	48.60	56.5	64.0
	39.6	192	BS 4825 / ASME BPE	47.50	56.5	64.0
	39.6	170	DIN 32676	50.00	56.5	64.0
65	-	-	ISO (for pipe EN ISO 1127 / ISO 4200)	-	-	-
	45.7	216	SMS 3017 / ISO 2852	60.30	70.5	77.5
	45.7	216	BS 4825 / ASME BPE	60.20	70.5	77.5
	-	-	DIN 32676	-	-	-

Flange connection

EN1092-1 (ISO PN16), ANSI B16-5-1988 or JIS 10 K
in stainless steel (316L - 1.4435)

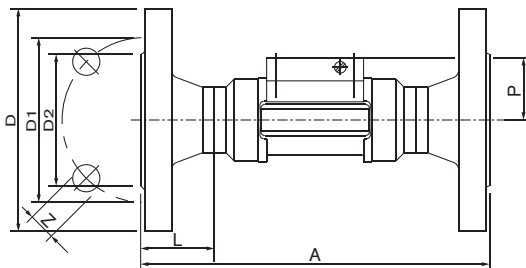

DN	P	A	Standard	L	Z	D2	D1	D				
[mm]	[mm]	[mm]		[mm]	[mm]	[mm]	[mm]	[mm]				
15	34.5	130	EN	23.5	4x14.0	45.0	65.0	95.0				
		130	ANSI						4x15.8	34.9	60.3	89.0
		152	JIS						4x15.0	51.0	70.0	95.0
20	32.0	150	EN	28.5	4x14.0	58.0	75.0	105.0				
		150	ANSI						4x15.8	42.9	69.8	99.0
		178	JIS						4x15.0	56.0	75.0	100.0
25	32.2	160	EN	28.5	4x14.0	68.0	85.0	115.0				
		160	ANSI						4x15.8	50.8	79.4	108.0
		216	JIS						4x19.0	67.0	90.0	125.0
32	35.8	180	EN	31.0	4x18.0	78.0	100.0	140.0				
		180	ANSI						4x15.8	63.5	88.9	117.0
		229	JIS						4x19.0	76.0	100.0	135.0
40	39.6	200	EN	36.0	4x18.0	88.0	110.0	150.0				
		200	ANSI						4x15.8	73.0	98.4	127.0
		241	JIS						4x19.0	81.0	105.0	140.0
50	45.7	230	EN	41.0	4x18.0	102.0	125.0	165.0				
		230	ANSI						4x19.0	92.1	120.6	152.0
		267	JIS						4x19.0	96.0	120.0	155.0

INLINE fitting dimensions

True union connection

DIN 8063, ASTM D 1785/76 or JIS K in PVC,
 DIN 16962 in PP or
 ISO 10931 in PVDF

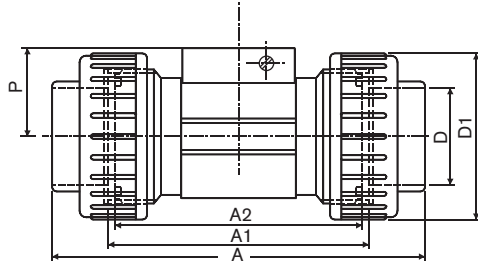

DN	P	A	Standard	A1	A2	D	D1
[mm]	[mm]	[mm]		[mm]	[mm]	[mm]	[mm]
08*	29.5	122.0 - -	DIN / ISO ASTM JIS	92 - -	90 - -	12.00 - -	- - -
15	34.5	128.0 130.0 129.0	DIN / ISO ASTM JIS	96	90	20.00 21.30 18.40	43
20	32.0	144.0 145.6 145.0	DIN / ISO ASTM JIS	106	100	25.00 26.70 26.45	53
25	32.2	160.0 161.4 161.0	DIN / ISO ASTM JIS	116	110	32.00 33.40 32.55	60
32	35.8	168.0 170.0 169.0	DIN / ISO ASTM JIS	116	110	40.00 42.20 38.60	74
40	39.6	188.0 190.2 190.0	DIN / ISO ASTM JIS	127	120	50.00 48.30 48.70	83
50	45.7	212.0 213.6 213.0	DIN / ISO ASTM JIS	136	130	63.00 60.30 60.80	103

* Only available in PVC

Spigot connection

DIN 8063 in PVC
 DIN 16962 in PP or
 ISO 10931 in PVDF

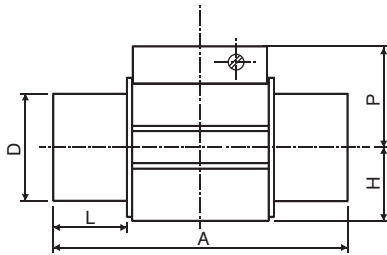

DN	P	A	Standard	L	D	H
[mm]	[mm]	[mm]		[mm]	[mm]	[mm]
15	34.5	90 85 85	DIN 8063 DIN 16962 ISO 10931	16.5 14.0 14.0	20	17.5
20	32.0	100 92 92	DIN 8063 DIN 16962 ISO 10931	20.0 16.0 16.0	25	17.5
25	32.2	110 95 95	DIN 8063 DIN 16962 ISO 10931	23.0 18.0 18.0	32	21.5
32	35.8	110 100 100	DIN 8063 DIN 16962 ISO 10931	27.5 20.0 20.0	40	27.5
40	39.6	120 106 106	DIN 8063 DIN 16962 ISO 10931	30.0 23.0 23.0	50	31.5
50	45.7	130 110 110	DIN 8063 DIN 16962 ISO 10931	37.0 27.0 27.0	63	39.5

Ordering chart for fitting S030

Port connection	Seal	Standard	Item no. DN 06 ** - 1/4"	Item no. DN 06** - 1/2"	Item no. DN 08** - 1/2"	Item no. DN 15	Item no. DN 20	Item no. DN 25	Item no. DN 32	Item no. DN 40	Item no. DN 50	Item no. DN 65		
Brass - with PVDF paddle-wheel - Temperature max. 100°C, PN16														
Internal thread	FKM	G	-	-	-	423 980	423 981	423 982	423 983	423 984	423 985	-		
		NPT	-	-	-	423 986	423 987	423 988	423 989	423 990	423 991	-		
		Rc (ISO7)	-	-	-	423 992	423 993	423 994	423 995	423 996	423 997	-		
External thread	FKM	G	552 557	552 527	444 023	423 998	423 999	424 000	424 001	424 002	424 003	-		
		NPT	-	-	449 182	-	-	-	-	-	-	-		
		Rc (ISO7)	-	-	448 668	-	-	-	-	-	-	-		
Metric	FKM		-	-	16x1.5mm 552 526	-	-	-	-	-	-			
Stainless steel - with PVDF paddle-wheel - Temperature max. 100°C, PN16														
Internal thread	FKM	G	-	-	-	424 004	424 005	424 006	424 007	424 008	424 009	-		
		NPT	-	-	-	424 010	424 011	424 012	424 013	424 014	424 015	-		
		Rc (ISO7)	-	-	-	424 016	424 017	424 018	424 019	424 020	424 021	-		
External thread	FKM	G	552 733	552 559	444 029	424 022	424 023	424 024	424 025	424 026	424 027	-		
		NPT	-	-	449 050	-	-	-	-	-	-	-		
		Rc (ISO7)	-	-	448 669	-	-	-	-	-	-	-		
	EPDM	SMS 1145	-	-	-	-	-	443 306	-	443 307	443 308	-		
Weld ends	FKM	EN ISO 1127 / ISO 4200	-	-	552 845 ¹⁾	424 028	424 029	424 030	424 031	424 032	424 033	-		
		EPDM	SMS 3008	-	-	-	-	-	443 298	-	443 299	443 300	443 374	
		BS 4825 / ASME BPE	-	-	-	-	-	443 369 ²⁾	443 370	443 371	443 372	443 373	443 374	
		DIN 11850 S2	-	-	551 788	551 789	551 790	551 791	-	551 792	551 793	-		
Clamp	FKM	ISO (for pipe EN ISO 1127/ISO4200)	-	-	-	424 034	424 035	424 036	424 037	424 038	424 039	-		
		EPDM	SMS 3017 / ISO 2852	-	-	-	-	-	443 302	-	443 303	443 304	443 399	
			SMS 3017 / ISO 2852*	-	-	-	-	-	443 387	-	443 388	443 389	443 720	
			BS 4825 / ASME BPE	-	-	-	-	-	443 395	443 396	-	443 397	443 398	443 399
			BS 4825 / ASME BPE*	-	-	-	-	-	443 400	443 717	-	443 718	443 719	443 720
			DIN 32676	-	-	551 794	551 795	551 796	551 797	-	551 798	551 799	-	
Flange	FKM	EN1092-1	-	-	-	424 040	424 041	424 042	424 043	424 044	424 045	-		
		ANSI B16-5-1988	-	-	-	424 046	424 047	424 048	424 049	424 050	424 051	-		
		JIS 10K	-	-	-	430 108	430 109	430 110	430 111	430 112	430 113	-		
Stainless steel - with PVDF paddle-wheel - Temperature max. 100°C, PN40														
Internal thr.	FKM	G	-	-	-	427 138	425 737	425 729	427 152	427 153	427 154	-		
PVC - with PVDF paddle-wheel - Temperature max. 50°C, PN10														
True union	FKM	DIN 8063	-	-	444 022	423 938	423 939	423 940	423 941	423 942	423 943	-		
		ASTM D 1785/76	-	-	-	423 950	423 951	423 952	423 953	423 954	423 955	-		
		JIS K	-	-	-	429 072	429 073	429 074	429 075	429 076	429 077	-		
Spigot	FKM	DIN 8063	-	-	-	423 944	423 945	423 946	423 947	423 948	423 949	-		
Extern. thr.	FKM	G	-	552 560	444 025	-	-	-	-	-	-	-		
True union without spigot	FKM		-	-	-	430 734	430 735	430 736	430 737	430 738	430 739	-		
		EPDM	-	-	-	430 740	430 741	430 742	430 743	430 744	430 745	-		
PP - with PVDF paddle-wheel - Temperature max. 80°C, PN10														
True union	FKM	DIN 16962	-	-	-	423 956	423 957	423 958	423 959	423 960	423 961	-		
Spigot	FKM	DIN 16962	-	-	-	423 962	423 963	423 964	423 965	423 966	423 967	-		
PVDF -with PVDF paddle-wheel - Temperature max. 100°C, PN10														
True union	FKM	ISO 10931	-	-	-	423 968	423 969	423 970	423 971	423 972	423 973	-		
Spigot	FKM	ISO 10931	-	-	-	423 974	423 975	423 976	423 977	423 978	423 979	-		
Extern. thr.	FKM	ISO 10931	-	-	444 028	-	-	-	-	-	-	-		

* internal surface finish Ra = 0.8 mm

** external thread

1) EPDM seal

2) DN 20 only available in ASME BPE

Ordering chart accessories / spare parts (other versions on request)

Description	Item no.
O-ring set	
FKM - for metal fitting, DN 06 to 65	426 340
EPDM - for metal fitting, DN 06 to 65	426 341
FKM - for plastic fitting, DN 08	448 679
FKM - for plastic fitting, DN 15	431 555
FKM - for plastic fitting, DN 20	431 556
FKM - for plastic fitting, DN 25	431 557
FKM - for plastic fitting, DN 32	431 558
FKM - for plastic fitting, DN 40	431 559
FKM - for plastic fitting, DN 50	431 560
EPDM - for plastic fitting, DN 08	448 680
EPDM - for plastic fitting, DN 15	431 561
EPDM - for plastic fitting, DN 20	431 562
EPDM - for plastic fitting, DN 25	431 563
EPDM - for plastic fitting, DN 32	431 564
EPDM - for plastic fitting, DN 40	431 565
EPDM - for plastic fitting, DN 50	431 566
Sensor holder	
Stainless steel with paddle-wheel (PVDF), gasket (FKM), screws and certificate for DN 06 and DN 08	448 678
Stainless steel with paddle-wheel (PVDF), gasket (FKM), screws and certificate for DN 15 up to DN 65	432 306
Stainless steel with paddle-wheel (PVDF), gasket (EPDM), screws and certificate for DN 15 up to DN 65	432 305
Stainless steel with paddle-wheel (PVDF), gasket (EPDM), screws and certificate, Ra int.= 0.8 mm for DN 15 up to DN 65	434 149
Stainless steel with paddle-wheel (PP), gasket (EPDM), screws and certificate for DN 06 and DN 08	554 896
Stainless steel with paddle-wheel (PP), gasket (EPDM), screws and certificate for DN 15 up to DN 65	449 425
Brass with paddle-wheel (PVDF), gasket (FKM), screws and certificate for DN 06 and DN 08	448 677
Brass with paddle-wheel (PVDF), gasket (FKM), screws and certificate for DN 15 up to DN 65	432 304
Brass with paddle-wheel (PVDF), gasket (EPDM), screws and certificate for DN 15 up to DN 65	432 303
Brass with paddle-wheel (PP), gasket (EPDM), screws and certificate for DN 15 up to DN 65	449 866
PVC with paddle-wheel (PVDF), gasket (FKM), screws and certificate for DN 06 and DN 08	448 674
PVC with paddle-wheel (PVDF), gasket (FKM), screws and certificate for DN 15 up to DN 65	432 298
PVC with paddle-wheel (PVDF), gasket (EPDM), screws and certificate for DN 15 up to DN 65	432 297
PVC with paddle-wheel (PP), gasket (EPDM), screws and certificate for DN 15 up to DN 65	443 982
PP with paddle-wheel (PVDF), gasket (FKM), screws and certificate for DN 15 up to DN 65	432 300
PP with paddle-wheel (PVDF), gasket (EPDM), screws and certificate for DN 15 up to DN 65	432 299
PP with paddle-wheel (PP), gasket (FKM), screws and certificate for DN 15 up to DN 65	552 881
PP with paddle-wheel (PP), gasket (EPDM), screws and certificate for DN 15 up to DN 65	443 983
PVDF with paddle-wheel (PVDF), gasket (FKM), screws and certificate for DN 06 and DN 08	448 676
PVDF with paddle-wheel (PVDF), gasket (FKM), screws and certificate for DN 15 up to DN 65	432 302
PVDF with paddle-wheel (PVDF), gasket (EPDM), screws and certificate for DN 15 up to DN 65	432 301
Approval / Certificate	
3.1 certificate	440 790
2.2 certificate	440 789
Rugosity certificate	444 898
3 points calibration certificate	550 676
FDA approval	449 788

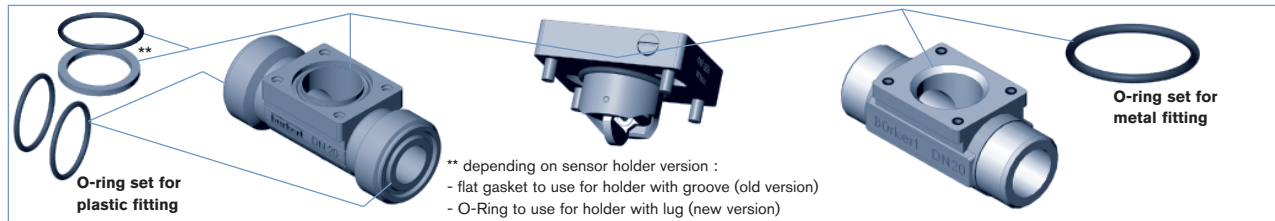

DTS 1000011766 EN Version: R validé printed: 26.10.2010 Status: RL (released | freigegeben |

Interconnection possibilities with the S030

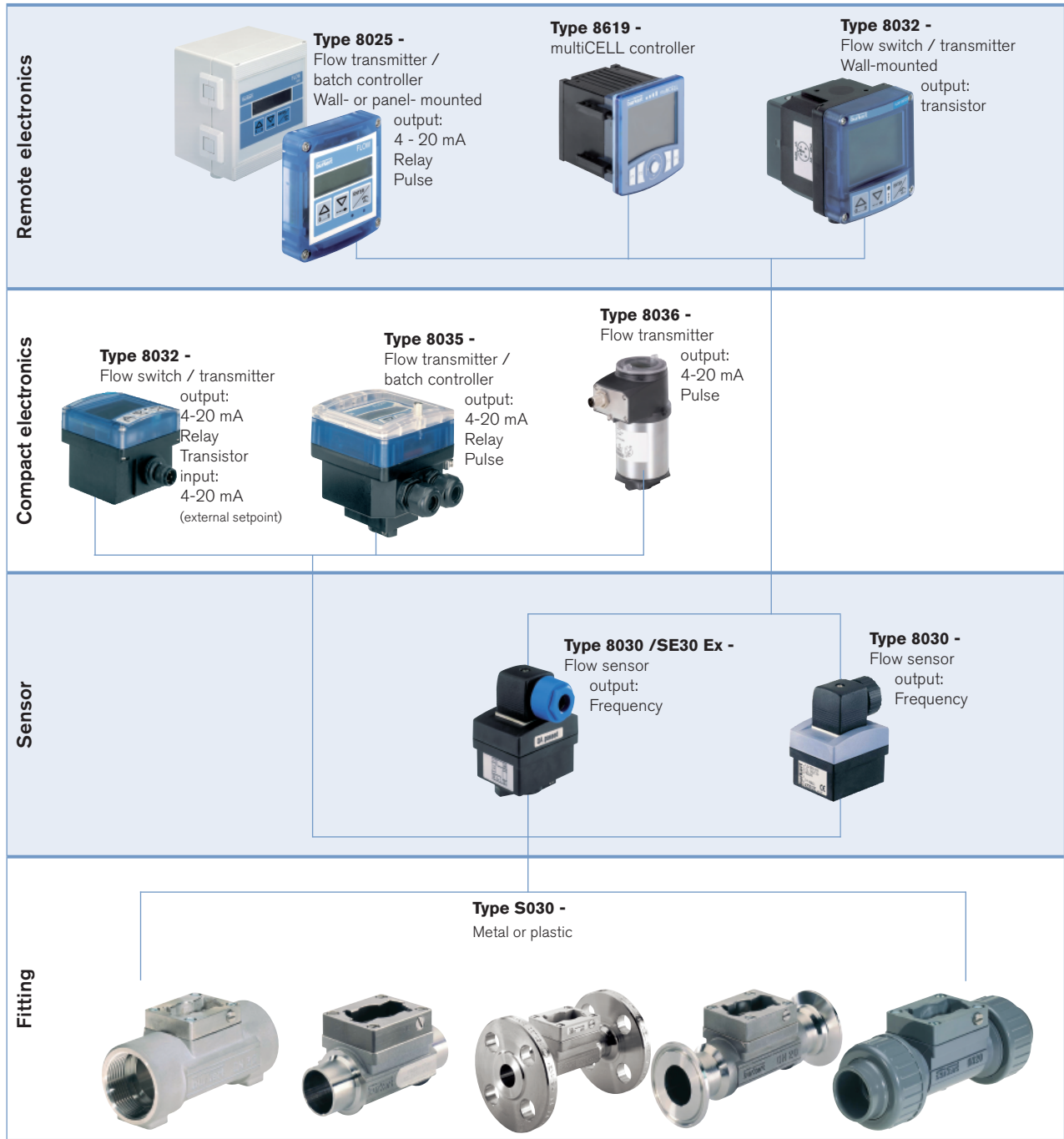

DTS 1000011766 EN Version: R validé) printed: 26.10.2010 Status: RL (released | freigegeben |

To find your nearest Bürkert facility, click on the orange box →

www.burkert.com

In case of special application conditions, please consult for advice.

Subject to alteration.
© Christian Bürkert GmbH & Co. KG

1010/8_EU-en_00891878